

The Gun Digest® Book of

# GUNS

For  
**Personal  
Defense**  
*Arms & Accessories for Self-Defense*



- Authoritative Reports
- Concealed Carry
- Handguns
- Shotguns



**Edited by Kevin Michalowski**

The Gun Digest® Book of

**GUNS** For Personal  
Defense  
*Arms & Accessories for Self-Defense*

Edited by

**Kevin Michalowski**

© 2004  
by KP Books

Published by



**700 East State Street • Iola, WI 54990-0001**  
**715-445-2214 • 888-457-2873**

Our toll-free number to place an order or obtain a free catalog is 800-258-0929.

All rights reserved. No portion of this publication may be reproduced or transmitted in any form or by any means, electronic or mechanical, including photocopy, recording, or any information storage and retrieval system, without permission in writing from the publisher, except by a reviewer who may quote brief passages in a critical article or review to be printed in a magazine or newspaper, or electronically transmitted on radio, television, or the Internet.

Manuscripts, contributions and inquiries, including first class return postage, should be sent to the Guns for PERSONAL DEFENSE Editorial Offices, Krause Publications, 700 E. State Street, Iola, WI 54990-0001. All materials received will receive reasonable care, but we will not be responsible for their safe return. Material accepted is subject to our requirements for editing and revisions. Author payment covers all rights and title to the accepted material, including photos, drawings and other illustrations. Payment is at our current rates.

CAUTION: Technical data presented here, particularly technical data on the handloading and on firearms adjustment and alteration, inevitably reflects individual experience with particular equipment and components under specific circumstances the reader cannot duplicate exactly. Such data presentations therefore should be used for guidance only and with caution. Krause Publications, Inc., accepts no responsibility for results obtained using this data.

Library of Congress Catalog Number: 2004105219

ISBN: 0-87349-931-X

Designed by Patsy Howell and Tom Nelsen  
Edited by Kevin Michalowski

Printed in the United States of America

# Contents

## Features

<b>Repetition Builds Skill</b> <i>by Kevin Michalowski</i> .....	5
<b>Laser Sights: Real Benefit With A Warning</b> <i>by Kevin Michalowski</i> ..	8
<b>Dry Practice: Build Confidence and Skills Off the Range</b> <i>by Dan Donarski</i> .....	11
<b>GPS of Personal Defense: Grip, Presentation and Stance</b> <i>by Dan Donarski</i> .....	16
<b>The Alpha and Omega: Complete Training</b> <i>by Dan Donarski</i> ....	21
<b>Buying Used Firearms Without Guilt, and With Low Risk</b> <i>by Patrick Sweeney</i> .....	26
<b>Bring Out the Big Guns</b> <i>by M.D. Johnson</i> .....	30
<b>The Trend Toward Autoloaders</b> <i>by M.D. Johnson</i> .....	36

## Catalog

<b>Modern Gun Values</b> .....	44
<b>Current Handguns</b>	
Autoloaders, Service & Sport .....	84
Double Action Revolvers, Service & Sport .....	108
Miscellaneous .....	115
<b>Current Shotguns</b>	
Military & Police .....	117
<b>Grips</b> .....	118
<b>Metallic Sights</b> .....	124
<b>Laser Sights</b> .....	128

## Reference

<b>Compendium of State Laws Governing Firearms</b> .....	131
<b>Guide to Right-to-Carry Reciprocity and Recognition</b> .....	134
<b>Product &amp; Service Directory</b> .....	152





# Introduction

Choosing a firearm for use as a defensive tool is a big decision. It is a statement about your willingness to accept the responsibility for your safety and the safety of those you love. A gun brings the power of life and death to your hands. Once you make the choice to wield such power you can only move ahead with the utmost diligence and care.

Understand that in a violent encounter all that you have learned, all that you believe and all the skills you have worked to acquire will be put to the test in a few terrifying seconds. Your survival and that of your loved ones will bear upon all of your decisions up to that point. Conversely, following such an encounter your skills, training and perhaps even your beliefs and attitudes may be subject to extreme scrutiny by the legal system. The choices you make must be correct. To be correct they must be based on facts collected through solid research and evidence presented by reliable sources.

So, now you have decided to keep a firearm for self-defense. Which gun is right for you? Unfortunately the criteria are quite subjective. The parameters are intensely personal. Will you be defending yourself in your home or on the street? Will you carry the gun concealed on your person or in a fanny pack, purse or attaché case? Do you have the physical strength and dexterity to handle firearm of a certain style or size? Which caliber will work best? That question alone can open the door to hours of debate that will not result in a clear answer.

Those who prefer to be glib might say, "The best gun to have in a gunfight is the gun you have

with you when the gunfight starts." That's a non-answer. How do you get from having no gun to making a knowledgeable decision about choosing an appropriate firearm for self-defense? You do research. This book is one portion of that research. It should by no means be your only point of reference. You will need this book and others. You will also need plenty of practical experience and advice from people you trust. This book will show you what's available and give you a good look at some of the options you have when it comes to choosing a gun for self-defense. Further

research will help you narrow the field. Practical experience will show what works for you and what doesn't. Effective professional training will make you proficient.

You may never need to use your firearm for self-defense, but when you do, nothing else will really do. And nothing but action backed up by confidence in your decisions will get you through such a trial.

You've made the choice. Now you begin gaining the confidence.

Kevin Michalowski  
Editor



***Once you've made the choice to use a handgun for self-defense, you need to get competent instruction to be able to use the gun effectively.***

# Repetition Builds Skill

By Kevin Michalowski

Whether you are swinging a golf club, dribbling a basketball or firing a round at the center of a target, the key to success is repetition. I read somewhere that a person must complete something like 7,000 repetitions to truly master a skill. Doing so teaches the muscles how the activity should feel. Once the muscles know what it feels like to complete an action, you begin to move almost instinctively. Once that happens you begin to see true consistency in your shooting and can work on increasing the speed of the sequence.

This, of course, works on the presupposition that your practice is based on proper techniques.

Therefore, the first step to effective practice is proper training. This is especially true when handling firearms for self-defense. A knowledgeable expert must teach you, and you must work diligently to emulate that training in your practice sessions. I will not pretend that an article of this length can cover all the salient points and subtle nuances of defensive firearms training. That training must be done on a range, under the watchful eyes of an expert. Find a school. Spend the money and while you are involved in the training, immerse yourself in the teachings of your instructor.

Then come home and practice... regularly.

Here are some tips to improve the quality of your practice sessions:

## **Focus on the fundamentals:**

High hand, crush-grip, front sight, roll the trigger. During the StressFire course Mas Ayooob made a clear point of telling every shooter that consistently accurate shooting cannot be expected with inconsistent firearms manipulation. In layman's terms: Hold the gun the same way every time. And to that end Mas wanted us to squeeze the gripframe hard for every shot. After that, focus on the front sight and control that trigger. Think about fundamentals and practice using them until they are ingrained. You high school coach was right when he said "you play like you practice." The skills you need come only from muscle memory. While training at Front Sight in Nevada, I was constantly reminded that in a real fight I would perform at only about half the level at which I performed in training. By focusing on the fundamentals I was able to raise my training scores to the point where I was confident that 50 percent would be good enough.

**Practice from real positions:** In a gunfight you will be shooting from cover or concealment. You will be shooting while moving to cover. You might even be shooting from odd or unstable positions. Within the bounds of safe shooting and range rules, shoot from non-standard positions. Use a post to simulate a barricade. Go prone. If it is safe to do so move to within 7 yards of the target and shoot while backing up. Just



*It takes 7,000 repetitions to build the muscle memory needed to master a skill. That means you have to practice the skill correctly 7,000 times before your body knows what it should be doing.*



remember all the while to focus on the fundamentals.

**Start slowly:** Speed kills. Going to town with serious rapid-fire training can cause you to forget the fundamentals. First, get good going slowly. Then get great going slowly. Then speed up.

**Quit when you get tired:** No matter how tough and strong you are, fatigue will compromise your shooting skills. If your performance starts to fade, stop the practice session. To build your endurance, don't practice longer, that could encourage you to adopt sloppy habits. Instead practice more often.

**Get a range bag:** Keeping an organized range bag is one of the best ways to insure productive practice. If you have everything you need in one place — ammo, hearing protection, targets, staple gun, etc. — all you need to do is grab your pistol and the bag and head to the range. When the practice session is over, simply put everything

back in the bag and you're ready for the next outing.

**Don't draw to the shot:** While it might seem like a good idea to practice drawing the pistol from your holster and shooting at the target, resist that urge. Remember, practice builds muscle memory and teaches us to reflexively complete the action. Most of the time when you pull a gun you will be holding someone at gunpoint and the situation may be defused without firing. If you have trained yourself to draw and reflexively fire, you may end up facing an angry district attorney who believes you could have solved the problem without firing a shot. A better means of practice is to draw (keep your finger off the trigger), and then command your "adversary" to stop and put down the weapon before you decide to fire. That's more likely the sequence you'll go through in a real self-defense scenario.

## ***What about ammo?***

All of this means you'll have to make an investment in ammunition. For several years I opted to reload ammo for my pistols and revolvers. Not having the latest and greatest reloading gear I soon found that I couldn't keep up. Figuring my time was worth something, I started looking at the real cost of reloading and determined that for my needs I was better off buying my ammunition in bulk.

At this writing I can, from any mail-order house, get 1,000 rounds of Wolf brand .40 S&W for \$125 plus shipping. At most gun shows I can save the cost of shipping. I use Wolf as an example because when I started shooting it a few people I know looked down their noses at this "imported surplus" ammo. They did so until I completed the 400-round StressFire handgun course without so much as a hiccup and qualified with a score of 299 out of 300. Wolf ammo may be imported, but it certainly is not surplus. I've never had reason to complain about its performance or accuracy and especially not the price. If there was one drawback to Wolf Ammo, it was



*Competent instruction insures that the foundation of skills you need will be laid correctly. No one can expect to simply pick up a handgun and use it efficiently.*



*Well-organized gear makes practice easier and more efficient. It also takes away any excuse not to head to the range. Find a good source of inexpensive ammo and hone the skills you've been taught.*

that the cases were lacquer-coated. Some people with really fast trigger fingers and lots of high-capacity magazines might, and I repeat "might" have experienced a jam if the chamber got hot enough to melt the lacquer. I never had it happen and never saw it happen even while watching thousands of rounds go downrange. But it gave some people a reason so complain. That reason is now gone. For 2004 the folks at Wolf replaced the lacquer with an advanced-technology polymer coating to several of their most popular center-fire calibers. I thought the stuff worked great before. They say it works better now.

There are lots of other ammunition suppliers out there and the shelves are full of books that can teach you all you need to know about reloading. Choose one supplier, or build your own reloading bench and get some ammo for you firearm. The bottom line is this. You need to practice and dry practice, while very important, can only take you so far. Shoot real ammo and shoot as much as you can afford. Building skill takes time and practice, but the benefits far outweigh the costs.



*Start slowly. Establish good form make sure you practice that form. Speed will come only after the basics are mastered.*



# LASER SIGHTS: Real Benefit With A Warning

By Kevin Michalowski

Almost since the invention of the laser people have been trying, with varying degrees of success, to use the instrument as a sighting device for firearms. As technology improved and dependable lasers became small enough to easily handle and mounting hardware began to provide repeatable accuracy, the dream of a laser sight became a reality.

Today you can, quite easily, equip a firearm with a laser, focus the dot on a target and fire for effect. And they work. Modern laser sights are small, light and durable. Modern batteries provide adequate power and the adjustments can be held in place under all but the most violent recoil. So, with all the hype and hoopla, should you or should you not equip your defensive firearm with a laser sight?

This is where the subjective nature of the debate takes over.

Yes, laser sights work. Some work quite well. But you need to review your personal needs and desires before you choose something on which you will stake your life.

Some of the benefits laser sights offer include:

#### **Instinctive Activation** —

Most lasers are pressure-activated. Just grip your gun naturally and the laser comes on. No on/off switch to find. No extra button to push. No fumbling when seconds count.

#### **Rapid Target Acquisition**

— The laser beam can be quickly directed to your target. In a life-threatening situation your eyes often lock on to the threat. With the beam projected on the target you can find it quickly and position it precisely.

**Enhanced Accuracy From Various Positions** — Without the need to acquire a traditional sight picture you can bring accurate fire to bear from a wide variety of positions, even those in which you are at a tactical disadvantage.

#### **A Measure Of Deterrence**

— The jury is still out on the reaction of a thug when faced with the flash of a laser sight. Some will cease hostilities. Some will only pause. Others may never even notice the presence of the laser. Remember, violent encounters happen



*This laser built into the grip panel of a J frame revolver is both unobtrusive and effective. Adding the sight requires no changes in the type of holster required or additional bolt-on gear outside the gun.*

quickly and the attacker may not be paying attention to a tiny red dot on his chest.

## ***The Other Side Of The Coin***

Just as it is true that for every action there is an equal and opposite reaction, any discussion of laser sight must include a review of their drawbacks. Laser sights are not perfect.

One major concern associated with laser sights is that all mechanical devices will eventually fail. Traditional iron sights are very tough, very simple and rarely fail. While the failure rate of laser sights may be very low, there is still the possibility that the shooter will engage the switch and have

nothing happen. And if that possibility becomes a reality, the owner of a laser-sighted pistol has to shift focus immediately. This shift in focus is both literal and figurative. With the laser sight in operation, all your attention can be focused on the attacker. That's a natural instinct and that's where the red dot from the laser is projected. Should that red dot fail, the shooter is required to develop an effective sight picture immediately and while under extreme stress. The stress is not only that of a violent encounter, but also the understanding that your aiming system has failed. To achieve a proper sight picture with your iron sights you must shift focus from the target to the front sight. The front sight must

be aligned with the rear sight and the combination placed on the target. To aim effectively, the sight must remain in focus and the target will appear out of focus. If you have come to rely on your laser sight and suppressed or completely forgotten the sequence of establishing a proper sight picture, this shift under stress can be very tough and will likely result in errant shots.

The ability to focus on the front sight during a high-stress and violent encounter is something that must be learned through repetitive practice. The common knock against laser sights is that they reinforce poor shooting habits. Used regularly, the laser sight can teach shooters to look over or around the gun and focus on the target, thus



*Inside the grip a laser sight is very simple, but there are things that can go wrong. Batteries can go dead and connections can fail. Still, the durability of many modern laser sights rivals that of adjustable iron sights.*

when the front sight is really needed the shooter will, under stress, forget that basic element of accurate shooting. Solve that problem by not using the laser sight regularly. Sight-in the laser at an adequate self-defense distance and leave it alone. Practice only with the iron sights. Run every type of drill you can think of using only the iron sights. Switch on the laser sight's master control only when you are not in a practice situation, but well before you find yourself in a self-defense situation. There's no need to be fumbling for a master switch under the stress of an attack.

Crimson Trace, makers of the Laser Grip laser sight, also embraces this philosophy. Here's a passage directly from their Internet site:

*At Crimson Trace, we believe you should always be able to sight and shoot a handgun without a laser. This new technology was never meant to replace your fixed sights, but to supplement them in difficult situations, like firing on the move or from awkward positions, defending yourself in close quarters, aiming in low light where iron sights are difficult to see, and any time that you're under stress. Under these kinds of conditions, our natural and automatic reaction is to focus on the threat, not the gun sights.*

That's a powerful statement from the maker of a tested and battle-proven product. While the comment points out the importance of acquiring and continuing to practice good marksmanship skills; it stops short of reminding those who carry firearms for self-defense that one of the toughest things to do under stress is shift focus from the threat to the sights of a handgun. To do so effectively requires continued practice in the fundamentals of good

marksmanship. Anything short of such practice will leave the shooter ill-prepared for the encounter. In that case, a laser sight should not be considered a quick fix. No competent firearms instructor would suggest anything but that a shooter first acquire proficiency with iron sights before moving to a laser.

With all that said, there are indeed some instances where laser sights provide a definite advantage. Indeed, in some situations a laser will work when almost nothing else will. In a close-quarters fight that quickly devolves in a struggle for your weapon a laser sight will help you get an aimed shot off even if you can't see the sights. This is where the laser sight really (excuse the pun) shines. In such a struggle one of the key elements of using a firearm at such close range is to insure you don't shoot yourself. The laser sight lets you know precisely where round will impact, regardless of your shooting position. Police officers can use a laser to sight around a tactical shield. This is not something the average armed citizen will be faced with, but it shows the ability to fire from an awkward position.

One often overlooked element of the laser sight is its benefit as a training tool. During dry practice the beam of the laser shows a shooter exactly what happens when a trigger is jerked. It can also prove to the shooter that double-action can be nearly as accurate as single-action, as long as the basic elements of marksmanship are adhered to.

The most talked about benefit of the laser sight has to be its performance in low light. Most attacks occur in low light and a laser will indeed help you get off an aimed shot. But it is still a shot in the dark. The best option for low-light fighting is to carry a light. Positive target

identification is of paramount importance. Not only will such identification prevent the tragedy of shooting an innocent person, it will also bolster your claim of self-defense during the inevitable investigation following the use of lethal force. With a light you know exactly who your target is and can clearly judge his intent. Streamlight offers a weapon-mounted light/laser combination or a Laser Grip accompanied by a hand-held light will accomplish the same things. Either way, the first rule of shooting is to know your target.

The other downside of a using a laser in a dark environment is that, like tracers, lasers work both ways. If your laser sight is casting beam directly from you to your target, it is also casting a beam from your target to you. The realistic odds of this having a huge bearing on the outcome of the shootout may be pretty slim, but it is a factor. Another factor could be the accidental activation of the laser when you are trying to hide. A pressure switch activates most lasers when the firearm is held in the firing grasp. In a high-stress situation, you can count on grasping your firearm tightly enough to activate the switch. Will that give away your position? Again, the odds are slim that you'll be in such a situation, but it is something to consider.

In the end, the decision to use a laser sight is intensely personal. In a real-world self-defense scenario, a laser will likely help you. But nothing is perfect and you should not stake your entire defensive plan on the benefits of a laser. Such a sight may indeed help in times of intense stress and in situations that require rapid response. Combine a solid base of effective shooting skills with a well-built laser sight and you will certainly have a combination capable of saving your life. ❄



# Dry Practice:

## *Building Confidence and Skills Off the Range*

By Dan Donarski

At the range with live bullets, shooting at standard silhouettes or, better yet, inside simulated scenario theaters, is far and away the finest way you can practice your weaponry skills. Or is it?

Firing on a range will definitely verify that our handgun actually fires bullets. Range firing will show us that our sights are aligned properly and our sight picture is correct. But, when push comes to shove, that is really all range firing does.

Now, if you live so close to a range that you go every day and you have an unlimited supply of ammunition, then, by all means, use the range for practice. Most of us don't live next door to a range, however. Getting to the range becomes a problem of time whether we like it or not. Nor is our ammunition supply unlimited.

So, how are we going to practice on a regular basis to get the skills necessary in a life-and-death situation? How are we going to maintain and improve upon the skills we have been taught?

### ***Dry Practice: What is it? Why is it Essential?***

That's where something called "dry practice" comes in. You may have heard of this before being referred to as "cold practice." No matter what you call it, dry practice is the method of building your skill and confidence level without the range and without bullets.

And, take care not to call this "dry fire" as it is impossible to fire an unloaded weapon without bullets. This distinction becomes



***Dry practice is the single most important training you will do. It trains everything from the grip to the presentation at the ready; to the surprise break to the quick and final check when the action is completed. Range firing validates your dry practice drills. It does not build them.***



absolutely vital on a range. There can be no confusion on this. It is called dry practice. Period.

No bullets, no punching holes in paper—how can that help? Actually it can, and does help more than you'd think. In fact, dry practice training is absolutely necessary to improving and ingraining your skills.

Think about it for a moment. The firing pin or hammer dropping on the primer, the bullet leaving the chamber and barrel of the gun, traveling to a target, is all the result of one single action. The trigger break is all that's needed. It is something as simple as curling your index finger.

In order to get to that simple step you need to master a number of other vital steps that occur before, as well as after, that simple finger curl. That's what makes dry practice so crucial. It allows you to practice the entire sequence of events from start to finish, from bringing the pistol to the ready position to re-holstering after the action.

There's another reason dry practice is essential. There are a lot of ranges that will not allow you to practice your skills with a handgun from a holstered or concealed position. We're not talking about target practice per se in this book, we're talking about personal defense. How many times will you be in a real personal defense situation when your handgun is already out of its holster and aimed at the target?

You need to practice realistically in order to practice perfectly in order to achieve perfect performance. Your handgun doesn't need practice in order to have the bullet leave the barrel. That process is simple mechanics. You need the practice, however, so your movements before and after the hammer fall become just as mechanical.



*Target acquisition, putting the front sight on the target's center mass, is certainly a critical skill to dry practice. It should become intuitive – where you point the bullet will travel—so you don't have to hunt for the front sight. Then it's time to take the slack out and get that surprise break, the terminal end of target acquisition.*

There is no way to mimic, or practice, one thing that will happen when faced with a potentially deadly situation. That one thing is the body's biologic response to the stress involved.

In a life-threatening engagement, your body will be under stress, a huge amount of stress. That stress will release a load of adrenaline. Adrenaline will have a huge negative impact on your body's ability to function coherently. Your mind will become a bit scrambled, your fine motor coordination will be significantly impacted in a negative way. Under these conditions you can only expect your body to be half as effective as it is under a non-stressful situation.

Dry practice, perfect dry practice done consistently, will help alleviate a good percentage of that degradation. When the movements and the skills become ingrained through practice drills, your body's ability to perform those skills under times of stress will not be as significantly impacted. You'll be better. Much better.

The Front Sight Firearms Training Institute puts it this way, "When faced with the stress

of a life-threatening engagement, we don't rise to the occasion, we descend to our level of training."

## ***The Mind Set and Practice Location***

It starts and ends between your ears. Safety is completely up to you and your ability to engage that computer located above your neck and set it to safe. Mechanical devices, devices like handguns, are not the safety issue. You are.

Dry practice is serious business, it is not play. You are practicing with a tool that, when coupled with the conscious act of trigger squeeze and ammunition, can take a life. The only thing missing in dry practice is the bullet. That is all. And that's everything.

As you become familiar with your handgun there is a better than good possibility that you will reach a point of familiarization where you "know" everything there is to know about it. At that point is when you become complacent. You and your familiarity have just become lethal.

Negligent discharges can be and often are the result of this complacency. In reality there is



*Before you go up on the range to validate a new skill, instructors run you through dry practice drills to ensure you know the movements. Think of dry practice as an extension of these drills and work them regularly to instill the muscle memory needed for the skills to become second nature.*

no excuse for a negligent discharge. None. During dry practice you must be absolutely focused on the task at hand. There can be no distractions. It must be structured. It must be serious. When it is there won't be any need for excuses. You'll never have to say, "I didn't mean to shoot."

Choosing a practice environment is crucial to the success of your dry practice sessions. The number one rule in choosing a practice location is that you must have absolute control over it. There can be no distractions.

The TV needs to be turned off. Same with the stereo. If there are family members in the house or apartment send them outside, the fresh air will do them good. Close the drapes. Take the phone off the hook. The point here is the dry practice room needs to be its own isolated environment. There can be no distractions. You must make this room as safe as physically and mentally possible.

Physical safety comes in the form of where you choose to do your dry practice. In the best of worlds you will have a room in the house that has a wall capable of stopping bullet. True, this practice is without ammunition, but...

Cinder block walls are ideal for this, so maybe the basement will be your best bet. The point is this, you want to use the absolute safest room possible, and then you make it even safer by taking out the distractions.

### ***Target Choice and Ammunition Separation***

It is all too easy to find a "convenient" target. Dry practice is not convenient, and neither should targets be those of convenience.

Targets should be specific. A simple piece of paper with a silhouette drawn on it is perfect. You can, and you should, dry practice at different distances,

using larger and smaller silhouette drawings to the feeling of depth. Tape these targets to a wall that could stop a bullet.

Never use a light switch or the corner of a room. Never a picture and never a television screen. In order to maintain the proper mindset, in order to maintain the controlled, distraction-free environment, your target(s) must be specific. They also must be used only during dry practice situations.

You can probably see why televisions, paintings and the like shouldn't be used. They are always around you and you may, at one point or another, be tempted to "practice" when you are not entirely focused. That is a very dangerous situation.

It is also very dangerous to have any ammunition anywhere near you during dry practice training. You need to separate yourself entirely from all ammunition.

The first step is to unload the weapon. Place the ammunition in





***Dry practice includes all the skills you have learned on the range and in the classroom, without bullets, including skills like tactical reloading.***

a container of some sort. Empty your pockets, ensuring there are no bullets. Take off any devices used to store ammunition such as magazine holders, speed loaders and all magazines. Empty the ammunition from all of these into the container you used when you emptied the weapon.

When all devices are empty and the ammunition is in one storage container, take that container and place it in another, entirely separate room. Return to

the dry practice room and double-check all of the carrying devices to ensure that they are free of all ammunition.

You will need the carrying devices to do your dry practice drills so return them now to their normal position on your belt or harness when you are armed.

So, where are we?

We have gained the proper mindset and are entirely focused. We have found a proper location to practice, free of all distractions

and safe. We have made targets specific for the purpose of dry practice. And finally we have ensured that there is no ammunition in the room in which we are practicing. It's time to actually dry practice.

## ***What to Practice***

In one word, everything. Every skill you know, every skill you have been taught needs to be practiced. Now is not the time to try out something new, however. Only practice those skills and techniques you are familiar with. Practicing beyond your scope of knowledge is downright dangerous and leads to ingraining bad habits in your memory.

Practicing the movements associated with loading and unloading must be covered. Remember, movements only. Gaining muscle memory is the reason for this. By repetition we learn.

Target acquisition, too. This includes a proper stance, a proper grip and bringing the



***Another skill that needs to be trained regularly to retain muscle and mental memory is what to do in the case of a malfunction. There are three basic types and all need to be practiced.***

handgun up so that the front sight is centered on the target. From there, practice aligning the front and back sights, concentrating on the front sight to gain an absolute focus.

And, it includes the potentially deadly action of the trigger squeeze. This includes taking up the slack and getting the surprise click of the hammer falling on an empty chamber. The front sight must not move during the hammer fall. If the front sight does move then it wasn't a surprise at all. At the range, or in a life-and-death situation, any movement of that front sight during the hammer fall will send the bullet off target.

Then there are malfunction problems to practice, practicing to replace empty magazines or use speed loaders, checking your surroundings after the hammer fall for any other potential threats— all must be practiced.

These skills mentioned above are just the basics. They apply to everyone in any situation imaginable.

There are different ways we carry our handguns however, different places we position them so they are available if the time comes. These contingencies must also be practiced in dry practice sessions.

For instance, say you have a handgun in your nightstand. If you do not practice the entire movement from opening the nightstand and establishing a proper grip and sight alignment then really how effective is that handgun in the nightstand? If you carry a handgun in a holster under a light jacket how effective can you be at a moment's notice if you haven't practiced gripping and clearing that pistol and bringing it to a firing position? What about inside a purse or a fanny pack? The point is this— you need to practice as close to real situations as you can.

Speed will be a concern to you at first. Everyone wants to be fast. But, at least initially, you should not consider speed at all. You need to practice absolutely correct techniques. After a period of time when you have used dry practice sessions in an absolutely correct manner you will find your speed improving. This is over time, not overnight.

## ***A Final Thought***

Back at the beginning of this chapter we talked about the range and live fire not being the best training for personal defense. Most ranges don't allow

shooting from a holster, much less a concealed carry position. Ranges don't have nightstands or desk drawers. You can't get to them on a regular basis in most cases. Bullets cost a fair amount of money. Yet, all of these things must become second nature, they must become ingrained into your muscle and nervous system memory for you to be consistently effective.

Have regularly scheduled dry practice sessions, say twice weekly. Use the range to verify your dry practice sessions. The dry practice sessions are where you will build upon your skills. ☆

The Front Sight Firearms Training Institute, located in Aptos, California, with its primary training center located just outside of Las Vegas, Nevada, has put together a comprehensive checklist to follow when engaged in dry practice. The institute's president, Dr. Ignatius Piazza, has graciously allowed its reproduction in this chapter.

### **Front Sight Training Institute Dry Practice Checklist**

- **Set a realistic dry practice goal before you start. A long practice session is not necessarily better because quality— not quantity— is the goal.**
- **Establish the proper mindset for dry practice.**
- **Establish and maintain control of your dry practice environment to eliminate all possible distractions.**
- **UNLOAD THE WEAPON AND YOURSELF and place the ammunition in another room.**
- **Chamber check the weapon to verify that it is unloaded and say, "The weapon is unloaded and I am ready for dry practice."**
- **Select an appropriately sized target and place it on a solid surface capable of stopping a bullet.**
- **Chamber check the weapon again and then begin dry practice.**
- **Terminate the dry practice session before significant physical and mental fatigue set in.**
- **Remove the dry practice target immediately upon finishing the dry practice session.**
- **Return the weapon to fighting mode— loaded and placed in its usual location such as a holster, fanny pack, briefcase, or nightstand.**
- **Say aloud, "The weapon is loaded and dry practice is over."**

*Copyright 2004 Front Sight Firearms Training Institute.  
Used by permission.*



# GPS of Personal Defense: *Grip, Presentation and Stance*

By Dan Donarski

The absolute beginning and end of personal protection, of self-defense, is your ability to fight through the adrenaline and yes, the fear factor, involved in a life-threatening situation. No matter how good you may be on the range, it is under conditions of intense stress that your abilities to protect yourself and your family or friends will be tested.

On the range there is no threat. You have plenty of time to load or reload, to align the sights on the paper or steel target, and easily take the slack out of the trigger and get that surprise trigger break sending the bullet downrange.

On a darkened street with an armed assailant or suddenly awoken from a sound sleep with a home invader those seconds disappear. Now is not the time to monkey around ensuring you have a proper grip. Your grip must be perfect. Now is not the time to wave the handgun around squinting at the sights trying to align them. Your sight alignment must be perfect.

In another chapter of this book you'll find a complete discussion of a style of training called "dry practice." In that chapter you'll find just how important this style of training is to your ability to function properly when the time comes. But, there are a few things you should consider before you start to dry practice in order to get the most out of it. Some of these won't change no matter how you choose to carry your handgun,



*Grip, stance and presentation are the ingredients for consistent accuracy. Range firing validates the practice that goes in to ensure all three are perfect.*

or even where you place it so it is ready at a moment's notice. Some will however.

## ***The Basic Grip and Presentation***

The one, single, most important skill to perfect is the basic grip. Calling it basic is almost a disservice as this basic grip is the end point in consistent shooting both on the range and in a life and death situation. There are not any variables in this. It must be done the same way each time your handgun is pointed downrange.

For the sake of clarification the grip is something you do, not something that is on the weapon. You grip the weapon by the tang.

No matter how the weapon is carried or stored you must grip

the weapon with the firing hand high on the tang. If your weapon is an autoloader the soft flesh found between your thumb and index finger is just underneath the slide. If your weapon is a revolver it is just underneath the hammer. That index finger of yours should be along the frame, just above the trigger and completely out from the inside of the trigger guard.

Once the weapon is cleared from its carrying position or stored position the weapon is brought up. Here you will be dropping and rotating your firing arm shoulder just a bit. The end result is that your firing arm elbow will end up being tucked into the area just below your firing side ribs. Your firing arm forearm will be parallel with the ground and the weapon will be

pointed in the direction of the threat. The trigger finger throughout all of this remains alongside the frame and away from the trigger.

Now, in one smooth and sharp move you use your firing arm to push the weapon forward while the supporting hand comes up to meet the firing hand. The thumb of the supporting hand covers the thumb of the firing hand while the fingers of the supporting hand cover the middle, ring and little finger of the firing hand. During this movement the safety on your weapon, if it has one, is disengaged.

The movement of the supporting hand to the firing hand is not a lazy, curvy move. It is done sharply. Think of it this



**Notice the position of the handguns of the two right shooters, both in the close contact position. On the far right, the shooter's handgun is pointed into the ground in front of him, not at the potential threat to his front. On his left, the shooter's handgun is pointed in the direction of the threat, ready to be used. This shooter is executing the close contact position correctly.**



**A firm grip. Arms thrust out; firing arm straight but not locked; elbows close in to the body; trigger finger along the frame and the handgun brought up to the eyes and the eyes locked on the front sight, not brought down to the gun and sight; all these make up getting the ready position right. Follow these rules and the shot, if the need arises, will be on target.**

way: The firing hand and arm, when thrust forward, is like a boxer throwing a jab. There is no curve to it, no bowling-like move. When the supporting hand comes up to meet the firing hand at the beginning of the move they should meet with authority and a slight clap heard when they do meet. Throughout this move the trigger finger remains alongside the frame away from the trigger.

Your firing arm elbow should have a slight bend to it. It should be a bit relaxed. The elbow should be pointed down with just a slight outward angle. If you lock out the elbow with a straight arm on the firing side you, will not be able to get a solid, unwavering sight picture. Your barrel will quiver in the least, which will throw any bullets off your desired target. The elbow of the supporting arm will have a pronounced bend with the elbow pointing straight down. Neither of the elbows is pushed out from the body. Rather, both are relatively tight to the body.

Your eyes are focused on the front sight, placing the sight center mass on the target. To put it simply, you are dead serious at this point.



Let's review where we are. We've established a grip high on the tang of the weapon. The weapon was brought up to a position close in to the body with the barrel pointed towards the target and the firing elbow tucked into the body and the firing shoulder dropped just a bit. From there the weapon was thrust forward towards the target while at the same time the supporting hand comes up and meets the firing hand with the supporting hand fingers overlapping. You are focused on the front sight and on the target and you mean business.

The next step in the grip is the meat of the matter. You can mess up any of the initial steps and while you will be compromised in one way or another, you can still be effective if this next step is done with precision. You must take that quiver out of the barrel. This is the accuracy step. Everything else is the presentation leading up to the accuracy.

Now you must match the tension that your supporting hand and your firing hand are applying to the tang of the weapon. The tension on your

firing hand will be that of a push. On the supporting hand the tension is a pull.

Your firing hand will be applying the push tension, pushing the weapon away from you, with the base of the palm where it meets the backside of the tang. Your supporting hand will be applying the pull tension, pulling the weapon back into your body, with the fingers wrapped over the firing hand fingers on the front of the tang. These must be equal because if they are not your bullets will not find their desired place on the target. They will go low if the push is greater, or go high if the pull is greater.

This is an exercise in isometrics. The force is applied on both sides equally, thereby creating a stable object, in this case, a stable handgun. It is this stability that leads to your bullet leaving the gun and reaching its desired target.

At this stage your trigger finger remains alongside the frame when in the ready to fire position or mode. It is a simple thing to drop the finger to the trigger and take up the slack, when in the point-and-shoot mode.

No matter if you are firing from a sitting position, like from behind a desk or sitting up in bed, or from a standing position, this basic grip will be a deadly asset to master. The grip, when done properly, is stable. When coupled with the precise presentation just covered, it is a lethal combination.

When you learn this basic grip and presentation to the point that the mechanics become second nature from regular practice there will be only one conscious thought left. That one conscious thought and decision is whether or not to terminally complete the trigger break and send that bullet off to meet its target. That is the only thought or concern you want to have running around inside your head when the time comes. It's the only one you can afford to have.

## ***Nightstands, Desks and the Like***

You know the grip, you know the presentation. Now, just where in that desk or in that nightstand are you going to place your weapon? The care you take with that answer, and the care



***Use another person to check your isometric, push-pull pressure of your grip. This will help you determine the proper amounts of pressure, and the placement of that pressure, when you grip the handgun.***



***A good grip looks and feels strong. An instructor can tell if you're doing things correctly by allowing you to apply your grip to her forearm.***

you take to make your decision a lasting one is vital.

First off there are not two or three good choices. There is only one. What works for me isn't necessarily the best for you. Before you decide on the where part of the equation you need to take extra care to ensure that the where, except for the handgun, is sterile.

Here are a few things to consider. Your handgun will be loaded, or the magazine holding the bullets will be filled and next to the gun. You will need to ensure that when the time comes the gun, and the ammunition-filled magazine if the gun is not loaded, is easy to reach with nothing in the way.

This means that nothing else should be in that desk or night stand drawer. Nothing—no papers or pens, no loose change, no loose ammunition. Nothing but the gun. It must be in a ready-to-fire state and you must be able to get to it without fumbling through a bunch of junk.

If you are just now going out to purchase a desk or night stand you are in luck because you can ensure that the “gun drawer” is at the front of the decision making process. If you already own one, then you are going to have to empty the drawer chosen as the gun drawer and put the junk in other places. Assuming a right-handed shooter, the desk drawer should be on the right as well.

How you place the gun in the drawer is also vitally important to your quick access to it when the need arises. It must be placed in the exact same place each time. Front or back is up to you, but keep in mind that when you open the drawer there is going to be a chance for that gun to move.

In a desk drawer, by keeping the gun in the far right, front corner you have two sides of the drawer to stabilize the gun in

position. The grip should be closest to you with the barrel pointing directly to the right. The magazine well, or butt of the handgun's tang should be snugged up along the front edge of the drawer. Placing it here affords a more natural angle to gain access to the gun. There are no hard corners to bend your arms or wrists around, just a smooth outstretch of the firing arm and the gun will be in a secure grip in your hand ready to be used.

In a nightstand the placement of the gun remains to the far right, front corner of the drawer. The magazine well or butt still remains closest to you but this time the barrel is snugged up against the front edge of the drawer. Why the difference?

When pulling out a desk drawer it is natural to pull with the firing hand, the hand on the same side as the drawer. In a nightstand, particularly after you've been become suddenly startled, it is a natural tendency to roll over and open the drawer with your left hand. As you'll be somewhere between lying down in bed and sitting up in bed, placing the gun in this way provides a more natural access.

Keep in my mind here that nothing works for everyone in gun placement. What matters most is to keep your gun stored and ready so YOU can get access quickly and naturally. Try a number of placements until you find the one that works for you. When you do make sure each time you put the gun into its drawer it is in the exact place every time.

## ***Purses and Handbags***

With purses and handbags the discussion about the clutter inside becomes possibly more vital than the discussion about the clutter in drawers. There are

going to be other items in the purse or handbag than the gun. You must deal with that fact from the start.

True, there are special holsters that are made to clip inside these things but that still doesn't overcome the ease of access problem. Even a holster securely clipped to the inside of a purse doesn't make access easy if assorted stuff is in the way on your way to secure the handgun. You can't afford the time involved in rearranging that stuff when faced with an ugly situation. You need free and easy access now.

No matter the style of purse, the most logical place to store the gun is at the front. The barrel should pointed down with the barrel snugged into the front edge and the tang extending back along the top. With a purse holster this is a relatively easy thing to do. If you don't own a holster then take the purse to a shoemaker or seamstress and have them sew in an extra triangle-shaped pocket that coincides with your gun's dimensions. Make sure the pocket sits right up to the top edge of the purse as you don't want anything to get jostled around and find its way on top of the tang thereby blocking your grip.

It should go without saying but nothing else goes into that special pocket but the gun. Ever. Like with the discussion about drawers, you'll have to find the best way to draw the gun out of the purse. You also must decide what style is best for you.

Are you going to use the supporting hand to grip the bag while the firing hand unzips or unbuckles the purse and then grip the gun? Is a zipper or buckle the best purse style or is one of those clam-shell types, the ones with a simple toggle at the top that, when undone, causes the purse to open on its own. The choice here is obviously yours,



but keep in mind that the choice to complete the trigger break is yours, too. Like most every thing when it comes to personal defense, the more exact you are, the more exact and precise your practice makes you, the better off you are. Seconds, or even their mere fractions, often count.

## ***What About Those Feet?***

We're talking about stance here, how you are going to place your feet and your body when you need to.

One of the best, and easiest stances to master is the modified



***The position of your feet should be at a 30-degree angle from parallel to the target/threat. This will feel a bit uncomfortable at first so practice is key. This position gives the shooter a more stable platform to shoot from than other varieties.***

Weaver stance. Basically this stance is one just shy of parallel to the threat or target. Your supporting side foot becomes the front foot. Your firing side foot becomes the trail foot.

Imagine a 30-degree angle cut back from the parallel firing line on a range, or back from parallel from an attacker. Your feet should be aligned along that 30-degree angle, as should your lower body up to the waist. From your waist you slightly turn your firing side shoulder into the target. The jab-like movement you make when you bring the gun up from alongside your body and the clapping of your supporting to complete the grip in the ready position will make this turn naturally for you.

While it is true that this stance does give any attacker a larger profile than a perpendicular stance would, a perpendicular stance is not at all stable. Much more than 30 degrees off parallel and your firing arm will become fully extended making it unstable. Much less, and the unstable body part becomes the supporting arm and sometimes even the firing arm.

Thirty degrees is a magic number here. Initially it will feel more than a little uncomfortable. After a few hours of practice it will become second nature.

In fact, everything we've discussed in this chapter will become second nature with enough practice. It needs to be second nature if you want to be pro-active in your own personal defense. As the name implies, it is personal, as in YOUR defense. How you prepare for it can mean the difference between successful defense and, if you live through it, an episode you rather not remember. If you haven't read the chapter on dry practice now would be a good time. ❁

# The Alpha and Omega: Complete Training

By Dan Donarski

Yes, except for those convicted of felonies, or those with a history of mental illness and a few other qualifiers, everyone else in the United States of America has the right to own a firearm. With some states there are a few more hoops to jump through, particularly with handguns, but thanks in large part to a vigorous defense of the 2nd Amendment the rest of have the right to keep and bear arms.

Without getting into a debate over something in which I have a deep and abiding belief, The Bill of Rights in all its glory, let me say this: Just because you have the right doesn't free you from the responsibility that goes along with exercising that right. I can think of no other freedom we have, that of owning firearms, that bears such a weighty responsibility. That beautifully simple freedom gives us the tool to take a life.

Nay-sayers to this belief would have us believe that guns kill people. Most of us would say that people kill people. Recently, while at the Front Sight Firearms Training Institute near Las Vegas I came to realize that both are rather trite. At Front Sight they have a saying that goes something like this: You are the weapon, the gun is the tool. It may be an exaggeration to say that seeing it put this way was an epiphany, but it was damn close. So close that it still sits at the forefront of my personal defensive posture. I am, you are, the weapon.

## *The Importance of Complete Training*

Just as you wouldn't want a 16-year-old kid to climb into a motor vehicle and take off down the highway without first going through structured training that includes a test of some sort, you



*Training will only be as good as the instructors who conduct it. Look for a small instructor-to-shooter ratio, nothing higher than one instructor to five students. This gives you the assurance of personal attention.*

probably also do not want any Tom, Dick, or Harry to go out, buy a gun and start carrying that gun concealed or blasting away without some sort of instruction. Preferably structured instruction rather than a single lesson from Uncle Joe or even the relatively simplistic training that is required by most states in order to get a carry permit.

And, no, definitely not, this is not to step on the 2nd Amendment. It is most certainly the realization that there are deadly serious responsibilities that go along with that right.

These responsibilities don't have an ending point. If you ever have to launch a bullet at an attacker and the attacker falls, well, your responsibilities and their consequences have just begun. They do have a beginning, however. It is the responsibility of making the decision to use lethal force, or not to use lethal force, if and when the time comes. From that first thoughtful decision to the bullet being launched and beyond, is complete training.

The mechanics involved in taking up the trigger slack, experiencing the surprise break in the trigger releasing the hammer or firing pin onto the primer and launching the bullet is basic. The thought process leading up to that point is most likely the most advanced mental gymnastics you'll ever deal with. Complete training takes all of this, the mental and the physical, into consideration. It trains both



the mind and the body to work in concert with one another to create an effective tool. It also asks the most important question you'll ever ask yourself right at the beginning.

Complete training trains the mind along with the body to function as one. Two-day courses, four-day courses and even longer should include both the mind and the body. You should, in choosing a course of instruction, make sure that both are covered. If one aspect is missing, and generally it is the mental part that will be missing, you are not training completely.

In writing his book, *Men Against Fire*, S.L.A. Marshall studied and personally researched all sorts of things that happen to men on the battlefield. One of the things he was able to document had to do with soldiers firing their weapons. It seems that barely 15 percent of those under fire would actually return fire at enemy personnel or positions. Even in the best-trained units that percentage was not more than 25 percent — one in four. That's right, the rest didn't fire back. At all.

Keep in mind that the men involved were under fire. Their buddies were getting killed. Their lives were in severe danger. They had the legal sanction of war to fire back without threat of civil or criminal repercussion. And the vast majority didn't shoot back. Certainly fear was a factor but there was another factor, too. This leads us to the question.

## ***The Ultimate Question, The Ultimate Consequence***

Are you prepared, willing and able to use deadly force to stop a robbery or an assault in your home or where you work? How



***Defensive handgun training is right for everyone. If you are going to carry, or place a handgun in the home for protection, then a complete training course should be taken.***

about a rape? What about an attacker preying on you, a family member, or someone you don't even know in the park?

If you own a gun then you certainly have the ability. If you have been well trained to use that gun then you are prepared. That leaves us with "willing." So, let's ask again, "Are you willing to use deadly force in situations like this?"

There is no single correct answer. The willing part of the question is a question on morals and ethics. How you answer these questions is purely personal, based on your moral and ethical beliefs. Morals are generally a personal reflection on right and wrong. Ethics are based collectively on the area you live in and coincide with generally accepted conduct.

In a course of complete instruction where should this question be raised? The answer is quite simple — right at the beginning. A course that doesn't ask this question in a serious manner is simply a course in handling firearms, not a personal defense course. Without a solid answer to the different scenarios you will not be properly prepared to defend yourself or your loved ones when the time comes.

At the Front Sight Firearms Training Institute the instructors ran us through a variety of scenarios in the classroom. They ranged from an attacker who wouldn't stop, to a roadside accident where one of the drivers became an aggressor. In each we were asked when or if we would present the handgun and when we would shoot. In more than one case the aggressor became the victor thanks to hesitation on the defender's part, hesitation in answering that question.

That's why your answer to the ultimate question is so important and why it must be asked early on during your personal defense training. Knowing the answer to the question when posed in different ways gives you the prior knowledge that you will act in a specific way. There will be no hesitation. You already know the answer.

Your training course also needs to go over the ramifications of what will happen to you if you are forced to use lethal force to stop an assailant. There are a myriad of civil and criminal liabilities to consider. You quite possibly will be cuffed and arrested. Legal costs in defending yourself against a



criminal complaint filed by the District Attorney and/or a civil liability case where the attacker's family sues you are a definite possibility. So is being pilloried in the press for acting in what they will call a "rash" manner. These are just a few of the consequences of your actions in a justified shooting.

When you know that you are willing to take the ultimate action in defending yourself or your loved ones your training absolutely needs to take the next step. The "when to shoot" question must be asked and answered.

## ***Justification Training***

Going hand-in-hand with the willing part of the equation, any personal defense course you participate in must include a good discussion of when the use of deadly force is justified. We use deadly here for a very specific reason. While you are training with your gun to stop an attacker, not to kill him or her, there is a real probability that when your bullet hits center mass on the assailant that you will, indeed, kill him.

Here's something to keep in mind throughout the discussion. No matter how justified you may feel, no matter how justified you actually are, whether or not it was reasonable or necessary may often rely on what the investigating officers and a jury of 12 may think. In other words the best gunfights, as that is what they are, are the ones you can avoid. Unfortunately there may come a time when avoidance is out of the question.

There are no hard and fast rules any personal defense course can give you to determine with absolute certainty when a shooting will be ruled justified. There is, however, a definite thought process involved that

will make the shoot/don't shoot question easier to answer. This thought process must be in your course for you to be prepared.

Questions that you must be able to answer after the course and when faced with an attacker would include these:

- Was the force used necessary rather than excessive?
- Was the use of force unavoidable?
- Was there an immediate threat rather than an imminent threat?
- Was it a threat to life or serious injury to the body?
- Are you free from any fault, from any instigation or escalation?

Did your attacker have the ability, intent and opportunity to kill you or cause serious injury?

These are just a few of the questions that you need to be trained to quickly think about. In a study by Mike Waidelich in the early 1980s, he found that the average armed assailant can travel just over 20 feet in one and a half seconds and cause a fatal wound. Waidelich also found that it takes that same amount of time for an average person to draw his weapon from his holster and fire one bullet into the center mass of a target. Basically that

means you have precious little time, and you are in immediate danger, when an armed attacker is within a distance of 10 yards. If these considerations aren't in the course you are thinking about signing up for you need to find another.

You should also look for a section of the course to include a thorough discussion on ways to persuade an attacker that his course of action is not all that bright. No, you are not going to become a psychologist here, but you will attempt to quickly persuade the attacker to quit his actions. Your vocal cords come into play here with simple things like yelling, "Don't come any closer," or "Stop! I will shoot," while you are presenting the weapon into the ready-to-shoot position.

At the end of this section of your personal defense course you must be able to positively determine if your shooting in specific situations is justified. If you have to wrestle through the answer you most likely shouldn't be shooting. Nothing is more serious than a gunfight. There are no winners— one side just loses a hell of a lot more. The so-called winner now gets to face the possible wrath of the police and the courts, the press, and



***You walk before you run. You also practice from close range before going for distance. It is at close range that most gunfights will begin and end. Center mass is the target, two-shot groups the goal.***

the inner questions and turmoil that will mark the rest of his or her life.

If you don't understand that the best gunfight is the one you avoid then you need to go back and take another course that thoroughly goes through the justification and ramifications of the use of deadly force.

A well-respected lawyer, and someone I hold in high personal regard, Doug Chester, offers these final thoughts on the subject of consequence and justification.

"It's interesting that you hit right on the big question. It is one thing to pull the trigger in a sanctioned situation, i.e., military. Your conscience is given a "free pass," and you have society's sanction (more or less) to terminate another human being," said Chester. "Not that this gets you totally out from under, as you still have to live with yourself, and you still have to wonder if you were right.

"In a non-sanctioned situation, like a burglar breaking into your home, or a street fight, the question is a lot tougher, and you will likely be subject to unsympathetic review. I find it infuriating when people second-guess cops for a split-second decision made in a dark hallway when they were telling some

eggplant to freeze and show his hands, and the eggplant does neither, and points a cell phone at the cops, and gets shot. Boards of inquiry and Courts will spend weeks re-hashing a second by second account of a shooting. This is totally unfair to the cop. It is also what you should expect as a civilian involved in a shooting, only you'll get worse. The problem is that the bad guy is not subject to these limitations. He acts on instinct without consideration of consequences. This gives him a major advantage."

Up until now the course of complete instruction has only touched on the mental process involved in the use of firearms or weapons in self-defense. And that's how the course should be laid out. Mental exercises, the mental debate, are by far the hardest to come to grips with. They are the defining quotient on the use of weapons for personal defense. On the range, with a weapon in hand, the rest of a complete training course becomes simple mechanics.

## ***Weapons Training***

That's not to downplay the importance of the correct way to use a weapon. The weapon is only as good as the person using

it. You need to know your weapon inside and out.

A complete weapons course will start from the beginning, showing how the weapon works and how it is taken care of. It should include a wide range of weapons in various actions as well as barrel lengths and grip sizes and styles. Just because you are a revolver fan doesn't mean it is the best choice for you. Just because that .44 Magnum with the 8-inch barrel is in your gun safe doesn't mean that it the right choice for carrying in a holster or placing in a purse or desk drawer. Only by using different styles will you be able to make a good decision on which one is right for you.

A basic defensive weapons course should start with you and your choice of weapon at short range, say 5 yards. First the instructors should go through the mechanics involved in the grip, stance and presentation of the handgun to the target gaining a good focus on both the front sight and the target. When this is mastered you begin firing two shot groups so that the hits are center mass on a human silhouette. After you reach a high degree of consistency the distance should be increased to seven, then 10 and on out to 25 yards.

Your course should teach you basic malfunction drills. You need to know how to clear a dud from your gun, clear a shell that has mis-fed into the chamber and execute tactical reloading all with the handgun in the point position. These should become reflexive actions, the only intellectual action is whether to actually shoot.

Actions after the shot is taken, checking the surrounding environment for any other threats, needs to be covered. You'll have a single focus after the shot, and that single focus must be broken to ensure the area is clear from danger. Front



***Initially speed will not be an issue. As the complete training course builds on your skills, speed training, with revolving targets will prove critical, and should be stressed.***





***Training should also include tactical scenarios or simulator training. Here we see an instructor putting a student through a shoot/don't shoot situation where every decision made and shot taken will be evaluated thoroughly. Even seasoned shooters get a bit nervous doing these, but such simulations build mental and physical confidence, the key to complete training.***

Sight uses the quick-check and final check method. It is one that is highly recommended.

After the shot(s) are taken you execute a simple head movement, looking both left and right with the weapon in the ready position. You then execute the final check by taking a step, left or right, and then rotating your head and torso as one, like a tank turret, while keeping the gun in the ready position. This is done after every shooting sequence. You must become reflexive in breaking through that tunnel vision.

A basic two-day course will build upon each technique. It should only go as fast as you can be taught. A rushed course serves no one but the instructor's wallet. What you want to accomplish in a basic course is the fundamentals involved. You want to be able to reflexively get into a firing stance. Reflexively go through the presentation of the weapon from a holster to the point position. Taking the slack out of the trigger, getting the surprise break and the reset of the

trigger without putting the slack back. You need to be able to hit center mass on the target.

Actual speed of presentation and firing, and the speed involved in clearing a malfunction will only become "fast" after a great deal of practice. Another chapter of this book goes through something called "Dry Practice," an excellent method of building speed through regular practice even when you are not on a range. You'll also find a chapter on grip, stance and weapon presentation and placement. Each stresses the reflexive nature of everything except the intellectual decision on whether to shoot or not. Everything except taking the shot must be reflexive and a good course will help get you to that point.

The basic course should also include at least one scenario where you will be shooting at photo targets, or choosing not to shoot in some cases, while inside a mock-up of a house or alley. One instructor should be tied to you for safety one way or another, and another acts as the voice of

the bad guy in the background, screaming and making noise, putting your shoot/don't shoot reasoning to the test.

A more advanced four-day course would start with all of the above but get into even more tactical situations. It should cover shooting from a variety of positions as well as shooting under limited light. Clearing areas such as doorways, around corners, and engaging multiple targets should also be trained. And there should be a wide variety of tactical scenarios that you go through.

In all cases a defensive weapons course, be it handgun, rifle, shotgun or edged weapon, must be a skill-building course. You didn't run before you could first walk, and you won't be good with a weapon until you first learn how it works and how it is to be used effectively in a step-by-step manner.

You say you don't need training? That you have all the bases covered? There is really no such thing as "complete training" as you must continue to train, to practice, to keep your skills sharp and your mind focused. Having the skills leads to confidence and confidence will lead to performance. Skills not practiced and refreshed are soon lost. Complete training means regular and proper training. It just doesn't end. ✪

(Author's note: The mental processes involved in the training for personal defense, along with the need for continued practice on a regular basis, was brought home after attending the Front Sight Firearms Training Institute's two-day Defensive Handgun Training course. Even after a career as an infantry officer where I was trained on all sorts of weapons, qualifying expert in each I might add, I have never been to a more professional course. It, or its four-day counterpart course, is a course I would highly recommend to anyone considering having a defensive weapon in the home or applying for a carry permit.)



# Buying Used Firearms Without Guilt, and With Low Risk

By Patrick Sweeney

Let's face it, new guns can be expensive. And even though people can make the argument, "What price is your life worth?" when you are buying a gun for personal defense, sooner or later, we all give in to the temptation of a used firearm. You might spot one that you've always wanted. Or one just like the one you learned to shoot with, and foolishly sold because someone offered you "a lot of money" for it. Or, someone has a solid firearm at a rock-bottom price, but there is no time because he is leaving town tomorrow or getting divorced next week.

Yes, it could be a great deal. Or, it could be a series of headaches, each more expensive than the last. How do you avoid the hassles? Firearms transactions occur in one of two

settings; A retail establishment or on the open market. (In states where all transactions must go through a dealer, the open market is the black market. You were warned. Do not write me from jail, bemoaning your fate.)

Dealing with a retail establishment has its own etiquette. The main thing you need to remember is to follow the advice your father gave you when he was trying to get you educated on appliances, vehicles and life insurance: Buy from an established firm that has been around a long time. Yes, you'll pay their markup. But what that markup gets you is their experience and a willingness to stand behind their product. You may be seeing your second-ever (fill in the model name or number) but an active gun shop

will have been at it for years, and likely seen dozens of them.

Ask the store staff what the return policy is. Don't assume there is one, and don't assume it is printed on the back of the receipt. It would be prudent for the store to print it, but a lot don't. You can usually expect to be able to return a firearm if it isn't as promised. If all the particulars check out as presented (correct headspace, straight barrel, clean bore, correct caliber) but the 80-year-old revolver you just bought shoots poorly, that was part of the risk you assumed when you paid \$79 for it.

A firearm should perform within the parameters of its type. If it doesn't, then you should be able to return it. If you buy a Winchester or Marlin saddle carbine, and it shoots two to three inch groups at one hundred yards, you have no cause for complaint. That is the expected average for such rifles. If the group is two feet to the right or left, then you have cause for return.

You can protect yourself in many cases by asking for a test period. In the two weeks following your purchase you should have a gunsmith inspect your new firearm, and test-fire it. If anything is wrong, you can return it within the time limit. (Be sure to get this in writing.) Car dealers do it, dog breeders do it, and many gun dealers also do it.



*You have lots of choices on the used gun market. Be careful and choose wisely. Clockwise from lower left – Smith & Wesson, Glock, S & W Lady Smith, Taurus PT111.*



**How your used gun shoots might have something to do with the ammunition. Try several kinds to see what works best. A used gun in good shape should function with nearly all factory-loaded ammunition.**

When you test, test honestly. Don't assume your new Tactical rifle will shoot sub-MOA groups with the grungy surplus ammo you keep behind the seat of your truck. Give it a fair test and feed it new factory match-grade ammo. If it won't perform, have someone else shoot it. I know we're all good shots, but let a better shot try it if you aren't having any luck. In fact, test any new purchase with factory ammo. Yes, we are all competent and accomplished reloaders, but now is not the time to be using them. Test with factory ammo, ideally with factory ammo that has a track record you are sure of. If you buy a used P-38 because you've always wanted one, and it won't shoot your 9mm reloads at all, where's the blame? You don't know. But if it won't shoot groups with Remington Match 9mm ammo that are smaller than a Volvo, you know the gun is at fault.

On the open market such as at a gun show, you have to keep in mind the Latin phrase *Caveat Emptor*. "Let the buyer beware."

You probably won't be offered a chance to return it, nor will you have a chance to test it and have it inspected. How can you protect yourself when buying a firearm on the open market? Get a written receipt, with a description of the firearm and accessories or features. Get the owner's name and address. If you agree to a return policy, write it on the back of the receipt. Both of you sign it. A receipt so-described is a contract, and with it you can later go to small claims court if you can't get the owner to take it back and return your money.

You can minimize your chances of getting shafted, and stuck with a bad deal, if you give the prospective new purchase a thorough inspection. You can't do a test-fire at the store or gun show (that would put us all in a very bad light) but you can look for the things that alert you to a bad deal.

First, look it over. Does the blueing/Parkerizing/hard chrome have the correct color? A reblued gun will look different than a factory blue job. The best bluers

cannot match what the factory did. It may look better, but a reblue isn't original. If the seller is telling you it is factory-new, but the color is off, you might ask why. Or just put it down and walk on. While you're checking the color, look at the edges and markings. A reblue job entails polishing, and a heavy-handed polisher will leave traces on the markings. You can see them "pulled" or "faded." A pulled marking has the buffing wheels marks dragged from the lettering. A faded marking has the letters partially obliterated. (You can do a lot of the visual inspection without even picking it up.) Do all the parts match in wear? Or is one part obviously newer? Is the blueing evenly worn, or is it worn in spots? Many lever guns have the blueing worn off on the bottom at the balance point, not a cause for concern. Is the stock equally worn? Or does the rifle have new wood and old blueing? Any mismatch is cause for concern and questioning. On rifles and shotguns, look over the stock. More than dents and dings (which can be treated later) you're interested in cracks and repairs. Look at the wrist of the stock, behind the tang. Is it cracked? If it is it won't shoot accurately, and probably will crack further when you shoot it. Look at the forend. Does the forend of a shotgun come off easily, too easily? Does it need to be wrestled off? Too easy and wrestling are bad signs. On rifles look at the barrel channel. Some shooters cannot help themselves, they must experiment. If someone has "free-floated" the barrel by way of a wood rasp and router, you've got to wonder what else they did. On handguns, look for dents and dings on the edges and muzzle. Dropped handguns often leave distinct marks from their fall and impact. Dropped guns can

be subtly damaged, and not ever be accurate again. Once your potential new gun passes the visual inspection, check the function. Does the bolt, lever, or operating rod move smoothly and freely? Does the safety click on and off? Does the safety actually prevent the mechanism from firing when it is on? What, the owner won't let you cycle the action or dry-fire it? Put it down and walk away. Yes, I know that many owners and dealers at gun shows want to keep their firearms from being excessively handled. Yes, I know that constant handling can wear blue and put dings in the stock. But if I'm in the market to buy something and the current owner won't let me perform safety and function tests, I walk on. I don't need the financial risk, and I've wasted too much time in the past trying to change small minds.

Having said that, would I make exceptions? Perhaps. But only if I was dealing with

someone with a known reputation, and I had the return policy in writing.

Open the action and look down the bore. Rifle, shotgun, handgun, they all have to have a clean and unpitted bore to shoot well. If the bore is shiny but slick, get a rod and patch to wipe it out. A pitted bore can be disguised by putting a heavy application of oil in it, and then carefully wiping the bore until the pits are hidden but the rifling (if any) shows. Don't put too much faith in bore scopes. Unless the barrel you are looking at is a top-grade match tube, with few rounds through it, the bore will look bad when magnified 10 or 25 times. A rifle with a slightly pitted bore may still shoot well (I have several that do) but you won't know until you test it. If you can't test and return, pass on the deal.

If it can be disassembled without using tools, then strip it. Look the parts over and see if they are matching in color, texture and wear. If you're

contemplating buying a recently shipped M1 Garand that came from the CMP, you probably won't find a lot of matching parts. But, you can ask to see the CMP papers.

If you're buying a new or used AR-15, then you'll definitely want to open it up and see if there are any M-16 parts that have slipped in. (Some shooters don't know the difference, and install whatever works or is cheapest.) Inspect the internals for tool marks and ground-on parts. Many shooters who have tried to assemble an AR ended up doing a lot of grinding and filing. If the receivers or barrel are altered, pass on it. Look at the front sight casting to see if you can spot any hammer marks. If someone took the sight off, they were probably up to no good. If the internal parts are ground-on, whittle the price down by their replacement costs.

Manufacturers who ship assembled AR's make sure the upper and lower match in color. If the AR you're looking at is two different colors, it is probably a parts gun. Be extra careful.

On self-loading pistols in general, check to make sure the magazine goes in smoothly and without binding. Then see that it falls out under its own weight when you push the mag release button. Some won't, like Glocks with early magazines or S&W's or Browning Hi Powers with magazine disconnectors. Does the magazine lock the slide open? Rack the slide and find out. Does the safety work? If it is a hammer-drop model, does the hammer drop? Drop a pencil down the bore, eraser end first, point it up and safety-drop the hammer again. While the pencil jiggles from the vibration, it shouldn't be launched. If it does, the safety isn't blocking the firing pin. Don't worry too much about slide to frame fit. On most guns a bit of play is no big deal.



***Check the safety or decocking lever on every pistol you are considering for purchase. An inexpensive pistol with a bad safety is no bargain.***



However, if the gun in question is offered as a high-end custom gun “with a few mags through it” and the slide wobbles on the frame, don’t buy it. The choices are all bad: it may not be custom, it may have a lot more ammo through it, or it may be someone’s first “custom” work.

What to look for on 1911’s could take a whole book. Make sure the safeties work and that the bore isn’t pitted. Remove the barrel and look at the lugs. They should be sharp and clean, with square edges and not be peened. If they are peened, the pistol probably needs a new slide and barrel, an expensive repair. If you’re contemplating buying a used 1911 that has been a competition gun, check the grip safety. Many old competition guns have the grip safety pinned or deactivated.

On revolvers, check to see that the cylinder turns smoothly. Slowly cock the hammer for each chamber, watching the cylinder. On each chamber, the cylinder should come fully into position when the hammer is cocked. Failure to “carry up” is a sign of hard use, and will need to be repaired. It can mean simply a new hand, or some minor extractor star work, or it could mean a new hand and extractor. If it won’t carry up, open and look at the extractor. If it has been filed or ground on, pass on it. Grab the cylinder with your off hand and try to move it fore and aft. If it moves more than a few thousandths, it has endshake. Endshake is another bad sign, and will have to be dealt with by a gunsmith by stretching the crane or installing bushing washers. Look at the forcing cone. Is it clean and sharp, or dark and eroded? A heavily eroded forcing cone can be corrected by setting the barrel back, but it takes a skilled gunsmith or a bit of practice to do it right.

So how do you gain all this knowledge so you can assess a firearm? Read. Talk to experienced shooters and collectors. Ask questions. Cruise the gun shows and look at hundreds of guns. Strike up a relationship with a local gun shop, and drop in once a week or so to see what’s new. If you want to get into a particular area of collecting or competition, then read up on it. Yes, it can be

expensive to buy a couple of hundred dollars worth of books to read, but you could lose that and more on one bad acquisition. Talk to the experienced shooters and long-time collectors at your gun club. And as with any other gambling, don’t play with money you can’t afford to lose. Keep at it long enough and you’ll make a mistake or two, but even a bad used gun is knowledge gained. ❖

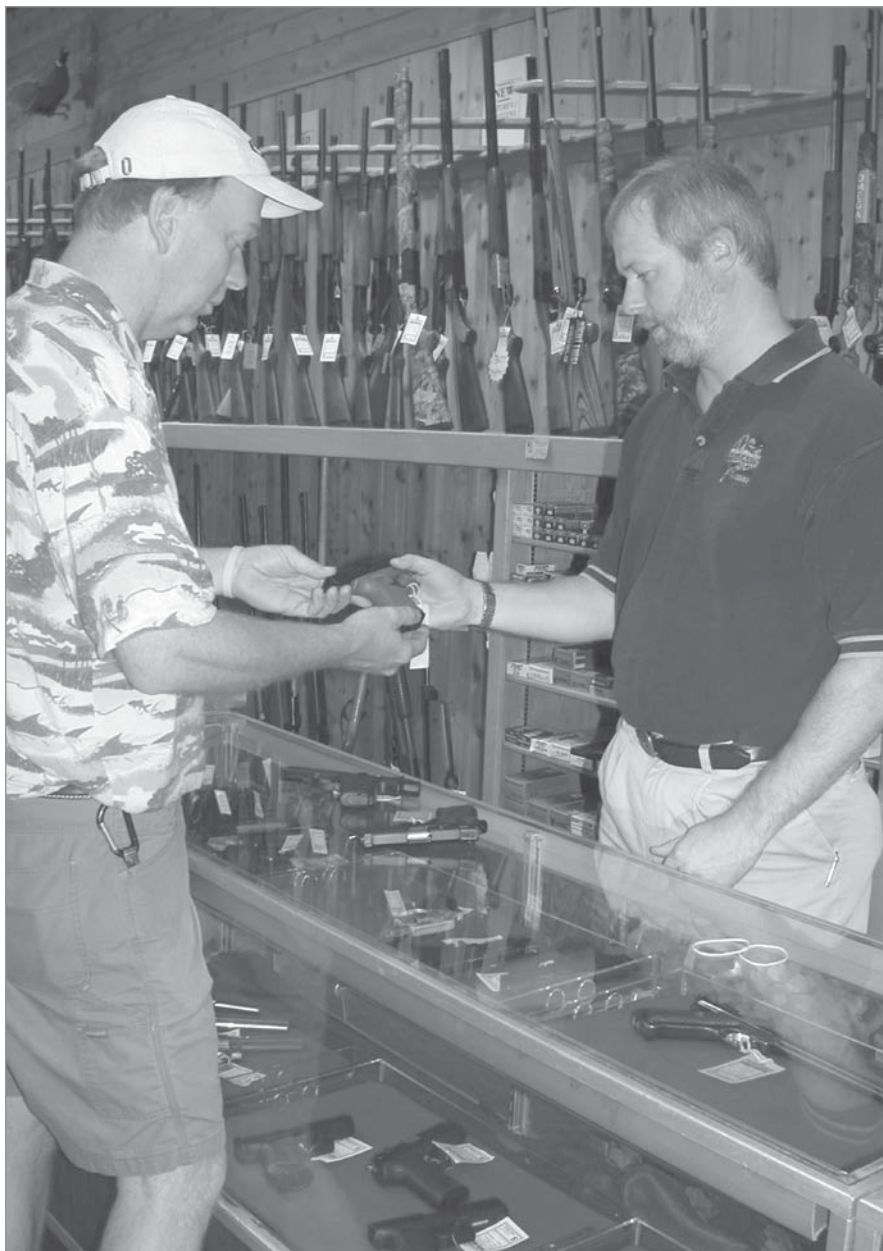

*The etiquette of buying a used gun in a gun shop is different than buying on the open market. In the shop you can ask about the warranty and sometimes be allowed to test fire the gun.*

# Bring Out the Big Guns

By M.D. Johnson

Let's face it – There are few things available to the average U.S. citizen that can prove as intimidating in a threatening or hostile situation as can a shotgun. There's just something about staring down that black, bottomless, manhole-sized abyss that is a 12-gauge muzzle – I've looked while cleaning, not while on the receiving end, mind you – that quite completely defines the word *fear*. Combine that with the unmistakable *schlick-schlick* sound of a pump-gun action being worked in the darkness, and even the legendary strongman, Hercules, might think twice about stepping, uninvited, inside the doorway.

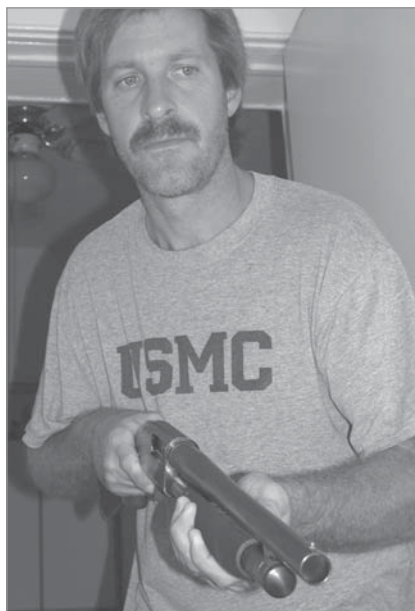

**A Mossberg Model 500, with 18.5" barrel and synthetic, twin-bar forearm – a workhorse, and a proven piece for both home and field situations. Bad guys fear this.**

And as if sight and sound weren't enough, there's the fact that while the man with the .32 ACP is shooting a single round with each pull of the trigger, he who carries a 12-bore filled with 2.75-inch shotshells containing OO buckshot can be secure in the knowledge that nine – NINE – of the same sized projectiles are headed downrange. Downsize to #4 buck in the same 2.75-inch shotshell, and he's increased that count to 27 .24-caliber pellets, each moving at roughly 1,300 feet-per-second (fps). That, my friend, is real power.

Despite these very obvious advantages, the shotgun as a self-defense firearm is not without its downsides. Let's take a look at the pros and cons.

## ***Shotguns – The good***

Let's discuss three factors why a shotgun might be considered for self-defense: Intimidation, Ease of Operation, and Margin of Error.

As mentioned before, there's just something intimidating about having a shotgun pointed at you, and often a 12-bore show of force has proved sufficient to end the threat before the situation has a chance to escalate. That's not to say that you should assume that the mere sight of a shotgun will be enough to strike fear into the heart of any burglar or would-be assailant. In such situations, you should never assume anything; however, instances where the

sight a home or shop owner armed with a 12-gauge has squelched an attack are numerous to the point of justifying the shotgun's role as Intimidator.

Ease of Operation means just that, that a shotgun can be an extremely simple machine to operate. And in a hostile situation simplicity can mean the difference between winning and losing. I say *can be* simple because a shotgun, like many other things, offers varying degrees of technological function – a point which will be discussed further in the section on Choosing an Action.

Finally, there is Margin of Error. With its multiple projectiles per round, the shotgun is may compensate for a number of variables, including fear, injury, target obstruction, target motion, and shooter movement. Any one of these could lead to inaccuracy and a delay or failure in subduing the threat. This element known as Margin of Error, when combined with the Intimidation Factor, can and often does contribute to a sense of confidence on the part of the defender or intended victim, and confidence is the first step to success and effectiveness. But simply having a margin of error does not mean to imply one does not have to aim a shotgun. Nor does it mean you should be firing rounds without positively identifying your target. A shotgun is a lethal weapon and all the same rules apply.



## ***Shotguns – The not-so-good***

On the downside, those who choose a shotgun for self-defense must deal with several factors limiting the gun's effectiveness. These include: Intimidation, Bulk and Recoil, and Ammunition Capacity.

In much the same way as a shotgun can be intimidating to a potential threat, the firearm can likewise be intimidating to the shooter. Shotguns are large, much larger than any pistol, and they kick hard. That can lead to a sense of reluctance; though, conversely, the sheer size of most shotgun ammunition can also contribute to a sense of security. It's a double-edged sword there.

We've mentioned that shotguns are by nature much larger than handguns, and herein lies another consideration – bulk. In close quarters, shotguns, even short-barreled weapons, can prove cumbersome and unwieldy. This is particularly true for smaller-framed shooters. And unlike pistols that can, if necessary, be fired one-handed, shotguns are, save for extreme situations, a two-handed proposition. Ordinarily, this one-hand versus two-hands debate isn't a consideration where shotguns are concerned; however, there is that one time in a thousand – an injury, perhaps – where a single paw is all that's available. There is, also, the concealment factor. My personal home-defense shotgun, a Mossberg Model 500, measures, with 18-inch barrel, 38 inches overall, which is fine given the weapon spends most of its time perched in a corner. Compare this measurement, however, to the .45 caliber Glock Model G20's overall 7.5 inches, and it's easy to see – literally – what the shotgun lacks as a choice for concealed carry.

Along with the potential of being cumbersome, there's also a shotgun's recoil to be considered. True, this recoil is likely to be dismissed entirely in a life-threatening situation; however, it still does exist. And then there's the recoil associated with familiarizing oneself with the self-defense shotgun. Should recoil be an issue, there is the option of downsizing and/or customizing the shotgun so as to make it more user-friendly. These alterations might include choosing a .410-caliber or 20-gauge weapon as opposed to a 12-gauge, using reduced-recoil ammunition, or installing recoil-reducing elements such as pads or barrel ports.

A final thought – and I hesitate to include this in a section on Cons – involves shotguns and ammunition capacity. High-capacity semi-auto handguns, depending upon the caliber, can offer the shooter from 10 to in some cases, 17 rounds. Shotguns, on the other hand, will range from the single shot's solitary offering upwards of six to eight rounds in most traditional (non-custom) weapons; extended magazine tubes can increase this 8-round maximum by a round or two. Initially, the balance in terms of ammunition capacity

seems to swing in favor of the semi-automatic pistol; however, when one considers that each of a 12-gauge pump's six 2.75-inch shotshells are filled with nine .32-caliber #00 pellets – That's 54 individual .32-caliber projectiles – a slightly different picture begins to unfold. That explained, do the pump-gun's six rounds put the shotgunner at a disadvantage in a threatening situation? That may be open for debate.

## ***Gauge or caliber***

For many individuals, this is point at which the debate begins. A 12-gauge, some say, is too heavy and, therefore, too unwieldy. Others counter, there is the intimidation factor is huge. Throw in discussions on customized guns and aftermarket add-ons and the 12-gauge sometimes seems to have very few drawbacks.

On the other side of the coin, there are those who condemn the smaller gauges – the 20-gauge and the .410-caliber – as being less than perfect based on such variables as pellet count and, in the case of the .410, the availability of factory-loaded ammunition designed for self-defense. Still, these “small” guns do have their advocates – those



***Big pellets, like this Environ-Metal “Hevi-Shot” 00 buckshot, stop fights quickly. This round and a good short-barreled shotgun make for an impressive combination.***

who would say that gauge, which essentially translates into pellet count, plays a minor role in the case of a shotgun being used in self-defense given that such situations, particularly those encountered in the home, are occurring at extremely close distances – 10 feet or less, on average.

For those considering shotguns, the choices include –

The 12-gauge – Perhaps the most popular gauge in home or self-defense shotguns due in large part to the availability of both guns and specialty ammunition. The 12-gauge is available in all four actions – single, double, pump, and semi-auto – and in a wide variety of price ranges. Barrels, too, are widely available. An excellent choice.

The 16- and 28-gauges – I mention these simply so as not to exclude them; however, neither the 16- nor the 28-gauge get much call in terms of self-defense weaponry. The shotguns can prove rather expensive and somewhat difficult to procure. Likewise, the ammunition, which, when found, is typically better suited for the upland bird hunter than the individual protecting his or her home.

The 20-gauge – A good choice, particularly if the firearm is to be used in the home. The 20-gauge is light, widely available, and produces less recoil than the 12-gauge. Like the 12, specialty (factory-loaded) ammunition for the 20-gauge can be had, and it does lend itself well to handloading.

The .410 caliber – Some would say the .410 caliber is too small to serve well as a self-defense firearm, and that its 11/16-ounce maximum shot charge is far too light to allow for a sufficient number of the larger (#4 Buck and up) pellets. However, that same 11/16-ounce load **does** hold a more-than-adequate number of

#4 or #5 pellets, which will prove effective in a close-quarters situation. An accurately fired .410 round is potent. Maybe not as potent as a 12-gauge, but four pellets of 00 buck will make an impact on someone bent on doing evil. Though not nearly as common as either the 12-gauge or 20-gauge, .410 caliber shotguns are offered by several manufacturers, and in all five (including a lever action) action styles. Of the three most popular gauges/calibers, the .410 produces the least amount of recoil, and can be easily handled by most shooters. The bottom line? It's worth considering.

### Action

Ease of operation, ammunition capacity, and personal preference help determine what type of shotgun action is *best* in the case of the home or self-defense shotgun. Regardless of the action chosen, however, familiarity with the firearm **before** a situation presents itself is paramount. That point cannot be over-emphasized.

**Single-shot** – Probably the least common type of shotgun action for home or self-defense is the single-shot. Recoil, particularly in the larger (12-gauge or 10-gauge) bores, can be considerable; however, it's the one-shot limitation that potential buyers find most undesirable. Add to this the need to cock the single-shot's hammer – a simple act on the range, but potentially troublesome in a darkened hallway when confronted adrenaline levels make fine motor skills difficult – and the single-shot becomes less and less an option. Specialty single-shots, however, are available. The Harrington & Richardson synthetic stocked *Tamer* single comes in a 20-inch barreled .410 version, while the H & R Topper series includes a 12- and 20-



*The jury's still out on the .410 as a home or self-defense caliber. Is it, or isn't it?*

gauge, as well as a .410, with a choice of 26 or 28-inch barrels. New England Firearms also offers a single-shot in their *Survivor Series*, available in 12- and 20-gauge and .410-bore configurations, with a lightweight synthetic stock and choice of 20 or 22-inch barrel. These options are easy on the budget, but if you can afford a different style of gun, you should look for one.

**Side-by-Side or Over/Under** – These days, save for those wielded by the sheriff in Old Western films, relatively few side-by-side (SxS) shotguns are seen in use or discussed as candidates for self-defense weapons, ousted, I believe, by the popularity, simplicity, and availability of the newer model pump-actions and semi-automatics. It's a shame, too, as the SxS makes for a fine choice for self-defense, despite its two-shot capacity which, the truth be known, isn't that much of a disadvantage as practice can smooth to rapidly the empty-break-load-empty routine. In most cases, the SxS offers a simple-to-operate piece, with an immediate choice in choke constrictions – typically, modified and full – a plus should an outdoors situation present longer distances. In addition, side-by-sides have been traditionally lightweight pieces, offering an ambidextrous top-mounted, and thus convenient, safety. Modern



side-by-sides, such as the *Coach Gun* by Stoeger (12- and 20-gauge and .410, 20-inch barrel, double triggers) are without question a force to be reckoned with.

Years ago, I knew a gentleman who kept a pristine Ruger Red Label 12-gauge over/under (O/U), complete with 26-inch barrels, next to his headboard. It was, as he claimed, the best security blanket that money could buy. And while I certainly don't doubt his claim nor the Ruger's role as metal comforter, it's seldom if ever you find an O/U serving as a self-defense or home defense piece. True, there's very little difference between the SxS and the O/U, save for the barrel configuration, so I attribute this discrepancy to tradition.

**Pump** – The workhorse of the shotgun family, the pump-action or simply, pump, is perhaps the most popular action type for defensive use, and the one with which the general public – thanks, Hollywood – is most familiar. A pump, be it a modern Remington 870 Special Purpose or an older Winchester Model 1897 hammer gun, is a reliable piece, able to withstand the rigors of repeated fire and harsh treatment. Barrels ranging from 18 to 22 inches are available, and stock/fore-end combinations of woods and synthetics are offered. All gauges, 12 through 28, as well as .410-bore, are currently being manufactured, with the 12-gauge and 20-gauge being the most often encountered in the home or field.

An interesting safety note about the pump-action as a defense gun revolves around the fact that such weapons can be stored loaded – that is, the magazine filled to capacity – without a round in the chamber. A shotgun stored as such is much safer should it fall into young and/or untrained hands; however, the same piece can also be readied for action in a split-

second simply by hitting the slide release and working the action and disengaging the safety

A plethora of pump-actions, either ready for home defense use or those easy-to-customize, are being made these days. These include models from Remington (M870 Express), Mossberg (M500), Winchester (The Camp Defender), and Ithaca Model 37.

**Semi-Automatic** – The advantage of the semi-automatic shotgun in a defense role rests in the weapon's rate of fire; that is, a round with every pull of the trigger just as quickly as the trigger can be pulled until the rounds, usually five to seven, are exhausted. The disadvantage, however, is the semi-auto's complicated innards – complicated, that is, in comparison to the less technically advanced pump-action and the downright simple side-by-side. There are simply fewer parts, and thus fewer malfunction potential, with the tried-and-true pump-action.

Also to be considered is the price factor, with semi-autos often costing two to two and one-half times that of a defense-specific pump-action. Pros and cons aside, the final word is that there are semi-autos available – the Remington 1100 and Winchester's Super X2 Practical MK II, for example – for those who might want them.

## ***Barrel length and choke selection***

In its simplest form, a shotgun barrel serves merely as a sighting plane. The longer the barrel, the longer the sighting plane. Take away, then, the need for this sighting plane, such as would be the case in a close-quarters defensive encounter, and this lengthy sighting plane becomes unnecessary. A constriction at the shotgun's muzzle, also known as a choke or

choke tube, works to create or maintain pattern density. And pattern density is most vital in those instances where distances from the shooter to the intended target begin to increase; that is, a full choke, or a choke that places a minimum of 85 percent of a shotshell's available pellets within a 30-inch circle at 40 yards, is a moot point at 10 feet, yet becomes an important factor at, say, 100 feet.

Given these explanations and knowing that most self or home defense situations unfold at ranges between 3 and 15 feet from the shooter, it becomes understandable that the defensive shotgun would need neither a lengthy barrel *nor* any degree of barrel constriction/choke. In terms of barrels, a short barrel – a tube ranging from the 18-inch legal minimum up to 22 inches – is both lighter and more maneuverable in tight quarters. Chokes in such barrels are typically fixed; that is, there are no interchangeable choke tubes to deal with. These chokes are commonly referred to as *open*, *improved cylinder*, *spreader*, or simply, *none*. Such constrictions offer acceptable up-close patterns with a variety of shot sizes ranging from #00 Buck to #4 lead, and are the recommended chokes when using specialty or less-than-lethal ammunition.

## ***Shotshells, shot size, and less-than-lethal ammunition***

In the case of shotguns and personal defense, it is shot size more so than shotshell dimension that lends itself to debate. Members of the "One shot and out of commission" group have their valid argument with larger projectiles - #00 Buck, for example – while there are those who would say that



*For shotgun defense work, 00 Buckshot is hard to beat.*

smaller pellets such as #2 or #4 lead have energy and penetration sufficient to stop any threat while at the same time posing a less-than-great likelihood of collateral damage to innocents in adjoining rooms. This debate goes on and on and will not likely be ended here.

Both schools have their points; however, let's begin with shotshell dimension. Even in those shotguns chambered for either 3-inch or 3.5-inch rounds, there is really no need for anything larger than the traditional 2 3/4 -inch shotshell be used in a defense role. Such 2.75-inch rounds offer satisfactory pellet counts – 12-gauge = nine #00 Buck pellets, 27 #4 Buck, pellets or roughly 200 #4 lead – while keeping recoil to a minimum. These smaller rounds also allow for increased magazine capacity. An exception to this may be when considering 20-gauge firearms. Here, the choice of a 3-inch shotshell, one which closer approximates a 12-gauge in hull capacity, would be advised.

As for shot size, the scales, both from a private as well as a law enforcement standpoint, seem to swing toward the larger pellets – the #00 Buck and #4 Buck. The thinking here follows that should a shooting situation become unavoidable, you want the threat neutralized quickly and completely; that is, without an opportunity for return fire. In close-range encounters, the nine

and 27 pellets, respectively, of the aforementioned buckshot rounds provide an excellent chance for multiple hits on target, particularly in the case of the #4 Buck, along with more than adequate retained energy and penetration.

Furthermore, and even at close ranges, the nine #00 Buck pellets do disperse wider than do their smaller counterparts, thus adding to a margin of error on the side of the shooter.

The argument in favor of smaller pellets - #2 or #4 lead, for example – centers primarily on these pellets being less likely to cause collateral damage. With less mass, and therefore less energy and penetration, these smaller projectiles, it's thought by some, perform their task and stop the human threat without

problems of over-penetration. Whereas the larger buckshot pellets can potentially wreck havoc in adjoining rooms, the smaller pellets will more often than not fail to penetrate common interior barriers.

Pellet for pellet, the smaller projectiles simply cannot provide the one-shot stopping power of the larger; that is, a one-pellet hit with .32 caliber #00 Buck will draw considerably more attention than will the same hit with a single .12 caliber #4 lead projectile. At a range of 15 feet and with a pattern roughly the size of a turkey egg, a 1-1/2 ounce charge of #4 lead shot leaves little room for error, whereas the 9-pellet load of #00 Buck is a bit more forgiving... at least for the shooter.

Although primarily a focus of the nation's law enforcement agencies, less-than-lethal (LTL) shotgun ammunition offers an interesting and increasingly effective alternative to traditional shotshells. Currently,



*Less-lethal ammunition exists, however many say it has no place in a home defense role. For police use, especially in a crowd-control situation, it can be very effective.*



several different types of LTL ammunition are available, including rubber buckshot, large rubber balls (2 per 12-gauge round), .73 caliber rubber slugs, and flexible batons or beanbags. Some, such as Lightfield Ammunition Company's innovative *Super Star* and *Star Lite* "koosh ball" 12-gauge round or the 40-gram Flexible Baton (beanbag) round from MK Ballistics, are meant to be fired directly at a perpetrator. Others like the rubber shot pellets are skipped or bounced onto the target. General consensus among law enforcement officers and self/home defense trainers is that LTL rounds are best used as crowd control, and not in a self or home defense role.

## Accessories

To me, accessorizing and customizing are two different things. Accessories are those things, slings for example, that work to make a firearm more user-friendly. Customizations, on the other hand, serve to make a weapon more functional and more field efficient. Such custom work might involve porting a barrel to reduce recoil, shortening or lengthening a stock, installing a non-traditional stock, mounting specialized optics or sighting devices, or extending a magazine tube thus increasing the weapon's ammunition capacity. These are the nitty-gritty; the accessories... well, they're often the gingerbread.

Still, both have their place in the realm of the self/home defense shotgun. Such accessories and customizations might include:

**Stocks and grips** – For a time, I had a black synthetic pistol grip on the Mossberg Model 500 that I maintain as a home defense firearm. And while it certainly did make the gun

lighter and much smaller, I didn't feel as though I had the same control over the piece as with the original walnut stock. Following some range time, I reversed my decision and reinstalled the original 13 1/4-inch stock. A recoil pad handles the recoil of the 2.75-inch #4 Buck rounds I've chosen, and the firearm, overall, provides me with something very substantial to hold on to.

The choice between a traditional (full-length) stock or a pistol-style grip on a self/home defense shotgun is one primarily based on fit, ability, and personal preference. Today's modern synthetic stocks are extraordinarily durable, not to mention being lightweight. Some, such as Mossberg's Model 590 synthetic, incorporate features such as the company's *Speedfeed Stock*, an altered piece capable of holding and quickly supplying four additional rounds. Traditional wood – often walnut – stocks are also an option, and often make for a less expensive, though just as reliable, piece.

Whereas a full stock offers a solid foundation and can contribute to improved accuracy, pistol-style grips also have their place. As mentioned, these short grips make for a somewhat easier-to-conceal weapon and cut down on the space necessary for storage – underneath a seat or mattress, for instance; however, the recoil of such short weapons can prove problematic or impossible to handle for smaller shooters. The bottom line in the stock versus grip debate rests then, elementally, with the individual. And finally, a hybrid. In the case of Mossberg's *HS (Home Security) .410*, a pistol grip is incorporated into the Model 500 pump-action's fore-end; a traditionally styled though synthetic full stock rounds out the piece. This hybridized fore-end allows for a

much surer, positive hold on that element of the weapon necessary to the firearm's repeated function, and is a definite plus when a shooter's hands are wet, either from rain or, understandably, perspiration.

### Sights and sighting devices

– Sights and self/home defense shotguns are, it seems, a relationship founded on personal preference and application. For the layperson who simply wants a dependable weapon for the purpose of protecting self, home, and property, a single front bead – the traditional shotgunner's sighting device – serves more than admirably. In most instances, the shotgun is pointed rather than aimed, and as such, a single sighting device like a lone front bead, is sufficient.

Military and law enforcement shotguns will often be seen with some type of after-market or customized sighting system; something other than a simple bead. Iron or buckhorn sights are one example, as is the large aperture *Ghost Ring* unit, a modern twist on the traditional peep sight, which allows for quick target acquisition. Laser or lighted sighting units are yet another option; however, and unless a quality unit is going to be purchased and professionally mounted, regularly maintained, and is made familiar through range time, it's advised that the fewer things to consider in the heat of a defense encounter, high-tech sights included, the better.

All in all, a shotgun is a wise choice for personal defense, especially in the home. While the gun can't really be concealed or easily carried, it works especially well if kept at the ready to defend against home invasions. In trained hands, all the elements that make a shotgun effective come to the fore and the gun serves as an outstanding fight-stopper. ❖

# The Trend Toward Autoloaders

By M.D. Johnson



**Autoloaders, like this Ruger P-89, are popular for many reasons. Chief among them is the speed of reloading.**

The world of the handgunner is surprisingly large; but there are really just two types of defensive handguns – the revolver, and the semi-automatic pistol. Since the mid 1980s there has been a decided shift among law enforcement agencies to adopt autoloaders as their primary weapons. Before 1980 most cops carried revolvers. Many of those revolvers were chambered for the .38 Special. Some fired .357 Magnum rounds. There was a long-held philosophy that revolvers were more dependable, simpler and safer than autoloaders. We can argue the nuances of such thinking for the next 100 pages of text and never satisfy everyone. Things began to change as a result of

several high-profile shootings in which law enforcement officers were quite simply out-gunned. In a couple of those shootings officers died trying to reload their revolvers. Those events started a serious review of handgun policies and training. From the FBI down to local police agencies, the real-world needs of officers on the street were held up to the test of “what if.” It became clear, rather quickly that the benefits of the magazine-fed pistol outweighed any perceived drawbacks. There was a wholesale change in the handgun philosophy of law enforcement officers.

People might not like to admit it, but the official adoption of a firearm by a government agency

can have a big impact on the buying public. The bigger the agency, the bigger the impact. Consider the Beretta Model 92 pistol. Once it was deemed good enough for the U.S. military, it suddenly became good enough for many police agencies and as a result, the general public fell in line. These days, while revolver sales are still holding their own, most people opt for a pistol when it comes time to think about self-defense. Here’s why.

## ***The semi-auto pistol defined***

Semi-automatic as it refers to a handgun means precisely that. In other words, the weapon fires once for each pull of the trigger. At which time the shooter must fully release the trigger and pull it again. This can be done until such a time as the ammunition supply is exhausted. The internal workings of the weapon eject the spent cartridge, slide a fresh cartridge into the chamber under the firing pin, and close the action, thus making the weapon “live” once more. Often, such firearms are, however incorrectly, referred to as *automatics*. Unlike semi-autos, true or *full* automatics require but a single pull of the trigger in order to exhaust the supply of ammunition. The German MP-40, a.k.a. Schmeisser, is an example of such a fully automatic firearm. True, the MP-40 and the Ruger Model P89 are both recoil-



operated *and* fire the same 9x19 round; however, beyond that, the similarities end, particularly when discussing semi-automatic versus true automatic fire.

## ***Why semi-auto: Pros and Cons***

Whether you're talking about a rolling pin or a Rolls Royce, everything short of perfection comes complete with a set of Pros and Cons. Such is the case with the semi-automatic pistol as a defensive firearm. And these variables, then, should be taken into consideration when you're deciding upon the category of firearm – revolver, semi-auto, or shotgun – which will be used in these defensive roles.

### **Pros**

- Most modern semi-autos are relatively simplistic in design and operation
- Intermediate calibers – .380, 9mm, and .357 SIG – provide options for women or seniors
- Large capacity magazines offer seven to 17 rounds
- Reloading is faster and easier than with a revolver
- Modern autoloaders can be safely carried with a round in the chamber
- Several frame sizes are available to fit nearly every hand and every defensive option
- Autoloaders offer a choice of single-action, double-action, and double-action-only

### **Cons**

- Some models may prove cumbersome, bulky, and/or heavy for some shooters
- Heavy recoil springs may cause trouble for some shooters
- Lacking pre-loaded magazines, reloading time

can increase dramatically over revolvers

- The operation of a semi-auto is more complicated than that of a revolver
- Improper ammunition choice or poor maintenance can lead to malfunctions

## ***Large, medium, small, and compact***

Before we delve into the details surrounding the various semi-automatic pistol frames and frame types, it makes sense that we first define this word – *frame* – as it applies to this particular firearm. The *frame is the main structure of the handgun to which the other components, e.g. grips, barrel, slide, trigger group, are attached.* In other words, the frame of the semi-automatic pistol can be compared to the foundation of your home. Construction begins with the foundation – the frame – and then everything is built on top of that.

In the past, the majority of semi-auto frames were constructed of either stamped or machined steel or aluminum. Today, however, an increasing number of these firearms, civilian, military and law enforcement styles, are being built on frames made of high-

tech synthetic polymer materials. Such frames are not only lighter than are their steel or aluminum counterparts, but they are also extremely low maintenance, impervious to changes in temperature, and virtually indestructible. On the *con* side, however, semi-autos sporting polymer frames, being lighter, will also exhibit increased felt recoil than will their heavier, steel-framed counterparts. That said, frame composition becomes a matter of fit, comfort, and recoil-handling ability.

Next is frame size. Modern semi-automatic pistols are offered in five different designations or classifications – large, medium, small, compact, and subcompact. Now, before you start thinking that a *large frame* means a large caliber and a *subcompact* denotes a smaller caliber, let me say that while it can be the case, it isn't necessarily the rule. For instance, 9mm semi-autos are available in large, medium, compact, and subcompact formats. But you can also get a subcompact .45 ACP. It's a handful to shoot, but great to carry. Such choices, then, lend themselves to questions on the part of you, the shooter – What is your physical stature? How large are your hands? To what extent



***There is an auto-loading pistol for just about every need and every hand size. Shop around for one that fits both.***



*The magazine is the heart of the reloading operation. Good magazines are the key to effective function.*

can you comfortably tolerate recoil? Will the firearm be carried concealed on your person? In a handbag or fanny pack? Or will the weapon be stored in a lockbox or bedside nightstand? The answers to these questions will help you decide which frame size, is best for you. Get to a gun shop or a gun show and handle several different sizes. If you can arrange it, go to the range and see if you can actually shoot some of the different models.

## **Choosing a caliber**

The question of caliber as it relates to semi-automatic pistols used for self-defense can best be answered by asking several different questions. These include:

- Does this caliber deliver enough power so as to be capable of eliminating or disabling any threat immediately, where the key word here is **IMMEDIATELY**
- Is the caliber so large as to be uncomfortable or unwieldy to shoot, thus affecting accuracy
- Does the caliber offer a variety of bullet weights and designs
- Is the primary purpose of this caliber (firearm) to be

home defense, street defense, or will it serve double duty

In the long run, it's Question #1 which carries the most significance, for it's possible to possess a comfortable, accurate handgun lacking the stopping power necessary to eliminate the threat *before* that threat can do you bodily harm. Likewise, it is also possible to possess a firearm fully capable of performing well in a self-defense role which has been mismatched with improper ammunition, thus decreasing or negating the weapon's effectiveness.

With this in mind, let's take a look at a list of popular semi-automatic calibers and cartridges, with an emphasis on bullet weight and design.

### **The .22 Long Rifle (LR)**

While it is undeniable that the venerable .22 rimfire is a joy to shoot, the caliber leaves quite a bit to be desired when it comes to self-defense. The problem? Even with high-velocity rounds leaving the muzzle at more than 1,300 feet per second (fps), the light 40-grain bullet – yes, even in a hollow point format – with their perhaps 150 foot-pounds of point-blank energy just don't have the immediate stopping power

necessary to classify them as a consistent, reliable self-defense bullet. Certainly, the perpetrator may eventually succumb to injuries received courtesy of a .22 LR, but the important term here is *eventually*.

Perhaps the .22 LR might best be used as a training tool on the range, with the intent being to upgrade to a larger caliber for applications either in the home or on the street.

### **The .25 ACP**

There was a period during the early 1980s, I believe, when the tiny .25 ACP semi-auto pistols, particularly those manufactured by Raven Arms, became quite trendy. Why, I'm not certain, as it was my experience that Black Cat firecrackers made just as much noise *and* were, in most cases, as accurate as the .25 ACP.

True, the .25 semi-auto does offer a small variety of bullet weights and designs ranging from a 35-grain jacketed hollow point (JHP) to a 50-grain full metal jacketed (FMJ) round; however, with velocities approximately half of the High Velocity .22 LR and less than 50 percent the energy at the muzzle when compared with the same .22 rimfire, the .25 ACP, again, leaves much to be desired. And in terms of range practice, most would be better served with a mid- to high-end .22 rimfire semi-auto for accuracy, ammunition availability, and ammunition cost.

### **The .32 ACP**

Some shooters consider the .32 ACP the bottom end of the self-defense ammunition curve. Others draw the line at .380. Regardless, the tale of the tape reveals the .32 ACP to have muzzle energy rating (120 to 135 ft/lbs) slightly less than a .22 High Velocity, and bullet weight options which include 60-, 65-,



and 71-grain projectiles. Bullet designs include FMJ, JHP, and Federal's Hydra-Shok round in JHP.

Like the .22 rimfire, the .32 ACP is enjoyable and inexpensive to shoot, both considerations which should lead to individuals spending ample time on the range acquainting themselves intimately with the capabilities and limitations of this borderline self-defense caliber. Range time is vital, particularly with the .32 ACP, as familiarity with the firearm leads to elevated accuracy, which plays a major role in this cartridge's effectiveness or lack thereof.

### **The .380 ACP**

Despite what was said earlier about the .32 ACP and the caliber's potential as a candidate for self-defense, it is with the .380 that many consider to be the least powerful cartridge for use in a self-defense pistol. Bullet weights for this popular caliber range from 85 to 102 grains, with a wide variety of bullet designs including Federal's Hi-Shok and Hydra-Shok JHP, FMJ, Remington's Brass JHP, and the Starfire Hollow Point, a quick-expansion offering from PMC. In comparison, muzzle energies for the .380 will be half again that of the .32 ACP, or from 180 to 200 ft./lbs. This brings the stopping power up to what some people might describe as "adequate" but is it still a long way from the "lightning bolt effect" you'd love to have when your life is on the line.

The .380 is head and shoulders above the .32 ACP in the realm of self-defense, but it's effective use still requires impeccable combat accuracy and perhaps working knowledge of human anatomy. If you know where to place the round and can put it in exactly the right spot, the .380 will work.

### **The 9mm**

By far the world's most popular pistol cartridge, the 9mm, aka 9mm Parabellum or 9mm Luger, has earned itself a self-defense role with police departments, security forces, and private individuals around the globe. Dozens of makes and models of 9mm semi-auto pistols, both foreign and domestic and, of course, of varying quality and dependability, are available. Ammunition, too, is varied, abundant, and relatively inexpensive – a plus on the practice side of the equation. Shooters can choose a 9mm in any frame size and some guns like the Glock and Springfield Armory XD series provide identical controls and nearly identical ergonomics between the smallest and the largest models.

Muzzle energy ratings for the 9mm will run from 290 to 295 ft./lbs. into the high 400s and low 500s, with many manufacturers'

offerings averaging from 325 to 370. On the low end, shooters can choose from a 95-grain Starfire HP from PMC up to several different 147-grain projectiles in configurations including FMJ and FMJ +P, JHP, and JHP +P. Here, the +P denotes a more powerful cartridge and indicates, on average, a 100 to 150 fps increase in muzzle velocity over traditional ammunition of an identical style (bullet weight and design). Bullets designed specifically for self-defense – the aforementioned +P, Federal's *Nyclad* (an encapsulated lead core with a patented nylon coating ensures reliable cycling in semi-autos), and the *MegaShock* (weight retention AND controlled expansion) by Lapua – are also available and might be considered. As previously mentioned, inexpensive FMJ ammunition is widely carried and can be used for familiarization and practice.



*It's fine to use inexpensive ammo for practice at the range. In fact, you should use lots of it and practice often. But also make sure your pistol feeds and functions perfectly with the self-defense load you have chosen.*

Recoil with the 9mm, even with some of the lighter smaller pistols, is still very manageable, even for those with smaller hands. And this decrease in recoil, or increase in controllability, does not necessarily translate into a corresponding decrease in the caliber's effectiveness as a self-defense choice.

### **The .357 SIG**

This is the new kid on the block. Designed by the folks at SIG-Sauer, makers of some of the world's best semi-auto pistols, the .357 SIG was created to duplicate the power of the .357 Magnum in a round that would fit into and function perfectly in an autoloader. Since U.S. police agencies began the wholesale switch to auto-loading pistols in the mid-1980s there have been complaints that the 9mm is underpowered. Lots of law enforcement agencies were also concerned, knowledgeable shooters would say wrongly, that carrying a Model 1911 (with its bigger .45 ACP rounds) in the cocked and locked condition was "dangerous." The search for an alternative yielded the .40 S&W, which will be discussed below. And thus was spawned the .357 SIG, now just a few years old. Several law enforcement agencies have adopted the round and most report that it does indeed deliver the "lightning bolt effect" of the old .357 Magnum wheelgun.

Despite these capabilities, however, the 357 SIG may never enjoy the popularity of the 9mm. The 9mm and the .40 S&W already have the lion's share of the defensive pistol market, especially in the military and law enforcement areas.

Several bullet weights are available for the 357 SIG, with the 124-grain, 125-grain, and 147-grain being three of the more

popular and most versatile options. You can expect sharper recoil as we continue to move up the power scale, but it is not oppressive. Where the .357 SIG really shines is accuracy. There are a couple handgun models on the market that allow the shooter to change from .357 SIG to .40 S&W by simply swapping barrels. The .357 SIG will outshoot the .40 every time.

### **The .40 S&W**

Introduced in 1990, the .40 S&W is quite honestly the product of litigation. To make a long story short, the FBI liked the 10mm, but some agents could not qualify with this monster cartridge and sued to be given a chance to shoot something smaller. When all was said and done, the FBI had to make serious change in policy and ammo companies and gunmakers came up with something to fill in the gap. Since 1990, the .40 S&W has taken the shooting world by storm, especially the area of law enforcement. This round takes up where to some the 9mm leaves off – and then some. Bullet choices for the .40 run the gamut from Federal's 135-grain Hydra-Shok JHP (1,190 fps and 420 ft/lbs at the muzzle) to a number of 180-grain loadings, including several +P rounds

Understandably, recoil will be more noticeable in the .40 S&W as compared to the 9mm; however, the lighter (135 and 150-grain) rounds, themselves proven better performers than the 180-grain offerings, are still quite manageable for all but the most recoil-conscious. You get only a little less power than the venerable .45 ACP and only a few less rounds than can be held by a high-capacity 9mm magazine.

### **The .45 ACP**

Imagine, if you will, getting hit by a half-inch marble going

647 miles per hour. That's the .45 ACP, one of the most recognized and most popular handgun calibers in existence today. Popularity, performance, precision, power, reliability, availability, versatility – the .45 ACP has it all in terms of a self/home defense firearm; however, that's not to say that the tried-and-true .45 isn't without its downsides.

Yes, it is undeniably a powerful piece, yet that power comes with a price in the form of recoil and physical weight; still, and with an eye on firearm design and ammunition selection, both variables – recoil *and* weight – can be kept down to manageable levels for most shooters. Too, the .45 ACP's larger rounds translate into decreased magazine capacity in the smaller guns. – 10 rounds, commonly, for the 9mm and .40 S&W compared to the .45's eight. It is a concern for some, but perhaps not for the civilian masses. And the crafty gun designers are everyday working out ways to stuff the government-limited maximum 10 rounds into small and smaller .45 ACP pistols.

Versatility and variety are but two of the areas in which the .45 ACP excels. The cartridge offers a wide range of bullet weights – factory loads from 165 to 230 grains – and designs, along with an almost infinite number of makes and models from manufacturers worldwide.

## ***Customizing your home/self-defense handgun***

Webster defines the word, *customize*, in this way – To make according to individual specifications. My definition differs slightly, that being "to make so as to be more user-friendly, and in essence, a more



effective or productive piece or whole.” Those definitions stated, let’s take a brief look here at the art of customizing the defensive pistol.

Before we get started, however, let’s consider the case where no customization is needed. Rather, the firearm from an energy/power standpoint meets any and all defense criteria, fits comfortably, and functions properly and reliably. The piece points well, and the recoil is more than manageable given the factory-equipped grips. The out-of-the-box iron sights are large enough to allow for quick target acquisition, but not so big as to be visually obstructive – that, and they perform as well in daylight as they do in low light. Should this be your new semi-auto handgun, my suggestion is this – Don’t mess with it. If you’re already a shooter, practice. If you’re not a skilled shooter, register for a firearms training and concealed carry workshop, pass it with flying colors... and then practice.

Granted, the scenario above is the ultimate. In many cases, an off-the-rack suit – it’s going to need a little alteration here and there. Below are some of the primary ways in which a handgun meant for self/home defense can be made more user-friendly.

**Lights** – Lights as they relate to personal defense and the use of firearms typically take one of two forms, a traditional hand-held flashlight, and a light source, conventional or laser, mounted directly on the weapon.

In most civilian defensive situations, a traditional battery-operated flashlight can prove more than sufficient. Obviously, such a hand-held light should be bright enough to adequately illuminate objects at an anticipated distance, be that the length or breath of an interior



*In most cases, when you need a gun, you will need a light. Get a good one.*

room, or the width of a commercial storage facility. Again, and obviously, batteries should of the highest quality, and should be checked frequently.

And replaced, if necessary

Two variables present themselves when discussing illumination for defense purposes, a.k.a. tactical lighting. The physical weight of the light source is one concern, one which in recent years has been addressed by those manufacturers using technologically advanced – lightweight – polymer materials in the construction of these flashlights. The weight of these modern hand-held lights has decreased, while the light (candlepower) generated has, in many cases, increased dramatically, thanks to improved power sources and better bulb/filament combinations.

NOTE – These modern

lightweight, or rather, *lighter weight* flashlights, like the heavy-duty four-cell and six-cell Mag-Lites®, can also serve as very effective weapons should the situation dictate.

The second consideration is one of inconvenience. Or rather, learning to accurately shoot with one hand while holding a tactical flashlight in the other. Some suggest using a light that offers a thumb-operated pulse switch located on the butt-end. With the firearm in the strong hand, the fingers of the OFF hand are wrapped around the light, thumb on the pulse switch. This is known as the Harries technique. As such, the hands can still be used in conjunction to stabilize both the weapon and the light. One can use the light to illuminate the target and, with enough practice, search with the light without pointing the gun directly at the center of the beam

of light. The goal here is to keep the light and the gun close enough to each other to properly index the pistol if you need to, but also allow you to search without pointing the gun at what might be an innocent bystander in a dark room. Too, the light can be operated as the switch intends, in pulses, rather than in a continuous, “Here I am, Bad Guy” beam. Simply explained, perhaps, but performing this feat requires both manual dexterity *and* practice.

Gun-mounted lights come in two basic forms – a traditional flashlight in miniature that is

affixed to the frame beneath the barrel using a special bracket or rail, and a laser unit that actually projects a small, often red, light onto the target. This laser light, or dot, coincides with the weapon’s point of impact. Both have their pros and cons. The traditional mini-light, when operated continuously as is often the case, can reveal your position; however, this same light, detached, can be operated in the same pulse manner as is any hand-held. The laser, on the other hand, simplifies aiming, yet can be alarmingly ineffective in bright light situations. Here,

as in many cases, it becomes a matter of personal preference, and then, familiarity.

**Sights** – Like lights, sights for the defensive pistol are largely a matter of personal preference. Condensed, there are four options:

Iron, traditional – These are the unpainted/unaltered out-of-the-box iron sights with which many of us grew up. They’re simple, can be adjustable or fixed, and allow for quick and easy target acquisition. Their downfall, however, comes in the dark, where they have a tendency to disappear.



*You must practice holding the gun and the light at the same time, so when the moment of truth arrives you are up to the task.*



Iron, colored – Here, several options, all revolving around the colors of the front sight and rear blade are available. There is the traditional and well-known “red ramp” where a portion of the front sight is milled away and filled in with color epoxy. Three-dot sights allow the shooter to simply line up the dots. They can be all white or a combination with the dots on the left and right of the rear blade one color and the front sight another color – white-green-white is common. There is the U/dot. Simply put the dot of the front sight inside the white U of the rear sight and you’re in business. SIG-Sauer has made famous the dash and dot system with the vertical dash on the rear blade. Simply “dot the i” and you have your sight picture. For low light shooting, you can have glow-in-the-dark paint or Tritium inserts. Tritium is a radioactive isotope of hydrogen that glows in the dark. It is commonly used to illuminate the hands and markers of modern analog watch faces. Because it does glow, tritium makes for an excellent choice in low and no-light situations. And because it requires no batteries...well, that’s just one less thing you have to worry about, isn’t it? The options are almost endless and there is an entire market for optional sights that shooters can explore.

Electronic – Optical electronic sights have come a long way in

recent years. While these mini marvels were once restricted to rifles or carbines, the size of the sights has dropped while the durability has improved. The optical electronic sight is now a realistic option for defensive handgun use. A couple of different styles from several makers are available. They are easy to use and quite accurate.

Laser or illuminating – The aforementioned laser sights, those which project a beam of red light onto the target, complete the more common choices. It should be noted that laser sights are not a cure-all, and should be employed in lieu of practice and familiarization with the firearm of your choice.

**Grips** – It’s essential that the pistol you choose for defense (1) fit, (2) be comfortable, and (3) be manageable from a recoil standpoint. Fortunately, all three of these points can be addressed simply by changing the grips.

Grips, for those unfamiliar with the nomenclature, are those pieces located on either side of the firearm’s frame and around which the hand is wrapped. Traditionally, grips were made of wood, hard plastic, ivory, staghorn, or other natural materials; however, in recent decades, high-tech rubber grips have very much come into their own.

In the case of most firearms and their shooters, the choice concerning grips is as individual a decision as is the make and

model of handgun itself. The key, then, is personal fit, a variable which can only be determined by a trial. Sometimes you can grab the grip and know if it feels good or bad. But a true test can only be made by firing live rounds – the more the better. If, as was mentioned previously, the factory grips provide the performance you expect and need, don’t change them. If they don’t and you opt for aftermarket grips, install them yourself or have them installed by a competent gunsmith, and then try the piece on the range. What you are looking for in a good grip is what some people call “full engagement.” Your hand is, to use the industrial term, the control surface. You must be able to get a firm hold on the gun and keep that hold regardless of stress, perspiration, sudden violent movement or anything else that may try to separate the gun from your hand. The grip also has to be the right size to allow you to fully reach the trigger of the pistol.

Combat trigger control is different than that of the target shooter. You should be able to reach the trigger with the first joint of the index finger. Target shooters will use just the tip of the finger. Remember too, that if the gun doesn’t fit, the problem may be that the frame is too large or too small. Look carefully and asked a qualified instructor if you have questions. ❖

# HANDGUNS

## Beretta

- Model 76
- Model 81
- Model 81BB
- Model 82
- Model 84 Cheetah
- Model 84F
- Model 85 Cheetah
- Model 85F
- Model 86 Cheetah
- Model 87 Cheetah
- Model 87 Target
- Model 89
- Model 89 Gold Standard Pistol

# MODERN GUN VALUES



Beretta Model 76



Beretta Model 84 Cheetah



Beretta Model 85F



Beretta Model 89



Beretta Model 84F

### BERETTA MODEL 76

Semi-automatic; single action; 22 LR only; 10-shot magazine; 6" barrel; 9 1/2" overall length; adjustable rear sight, interchangeable blade front; non-glare, ribbed slide; heavy barrel; external hammer; checkered wrap-around plastic (76P) or wood (76W) grips; blued. Also known as New Sable. Introduced 1971; dropped 1985.

Perf.: \$350 Exc.: \$300 VGood: \$275

With wood grips

Perf.: \$400 Exc.: \$350 VGood: \$325

### BERETTA MODEL 81

Semi-automatic; double action; 32 ACP; 12-shot magazine; 3 13/16" barrel; 6 13/16" overall length; blued finish; fixed sights; plastic or wood stocks. Introduced 1976; dropped 1981.

Perf.: \$375 Exc.: \$250 VGood: \$200

Nickel finish

Perf.: \$350 Exc.: \$300 VGood: \$250

With wood grips

Perf.: \$300 Exc.: \$275 VGood: \$225

Beretta Model 81BB

Perf.: \$300 Exc.: \$275 VGood: \$225

### BERETTA MODEL 82

Semi-automatic; double action; 32 ACP; 9-shot straightline magazine; 3 13/16" barrel; 6 13/16" overall length; weighs 17 oz.; non-reversible magazine release; blued finish; fixed sights; wood grips. Introduced 1977; dropped 1984.

Perf.: \$275 Exc.: \$250 VGood: \$200

Nickel finish

Perf.: \$350 Exc.: \$300 VGood: \$250

### BERETTA MODEL 84 CHEETAH

Semi-automatic; double action; 380 ACP; 10-shot magazine; 3 7/8" barrel; 6 13/16" overall length; weighs 23 oz.; black plastic (84P) or wood (84W) grips; fixed front sight, drift-adjustable rear; blue finish; squared trigger guard; exposed hammer. Imported from Italy by Beretta U.S.A. Introduced 1977.

Perf.: \$400 Exc.: \$325 VGood: \$275

Blue, wood grips

Perf.: \$375 Exc.: \$350 VGood: \$300

Nickel, wood grips

Perf.: \$475 Exc.: \$400 VGood: \$325

### Beretta Model 84F

Same specs as Model 84 except combat-style frame; grooved triggerguard; plastic grips; manual safety; decocking device; matte finish. Made in Italy. Introduced 1990; still in production.

Perf.: \$350 Exc.: \$325 VGood: \$275

### BERETTA MODEL 85 CHEETAH

Semi-automatic; double action; 380 ACP; 8-shot straightline magazine; 3 7/8" barrel; 6 13/16" overall length; weighs 23 oz.; black plastic (85P) or wood (85W) grips; fixed front sight, drift-adjustable rear; non-reversible magazine release; blue finish; squared triggerguard; exposed hammer. Imported from Italy by Beretta U.S.A. Introduced 1977; still imported.

Perf.: \$350 Exc.: \$300 VGood: \$250

Blue, wood grips

Perf.: \$375 Exc.: \$325 VGood: \$275

Nickel, wood grips

Perf.: \$425 Exc.: \$375 VGood: \$325

### Beretta Model 85F

Same specs as Model 85 except combat-type frame; grooved triggerguard; plastic grips; matte black finish; manual safety; decocking device. Made in Italy. Introduced 1990; dropped 1990.

Perf.: \$375 Exc.: \$325 VGood: \$275

### BERETTA MODEL 86 CHEETAH

Semi-automatic; double action; 22 LR; 8-shot magazine; 4 7/16" barrel; 7 5/16" overall length; weighs 23 1/2 oz.; fixed sights; tip-up barrel; checkered walnut grips; matte finish; gold trigger. Importation began 1991.

Perf.: \$450 Exc.: \$375 VGood: \$300

### BERETTA MODEL 87 CHEETAH

Semi-automatic; double action; 22 LR; 7-shot magazine; 3 7/8" barrel; 6 13/16" overall length; weighs 21 oz.; black plastic grips; fixed front sight, drift-adjustable rear; blue finish; squared trigger guard; exposed hammer. Imported from Italy by Beretta U.S.A. Introduced 1977; still imported.

Perf.: \$450 Exc.: \$375 VGood: \$300

### Beretta Model 87 Target

Same specs as Model 87 except single action; 6" barrel with counterweight; wood grips. Made in Italy. Introduced 1977; importation began in 1986; still imported.

Perf.: \$500 Exc.: \$425 VGood: \$350

### BERETTA MODEL 89

Semi-automatic; single-action only; 22 LR; 8-shot magazine; 6" barrel; 9 1/2" overall length; weighs 41 oz.; interchangeable front sight, fully-adjustable rear; semi-anatomical walnut grips; fixed monoblock barrel machined from forged steel block; aluminum alloy frame; manual safety on either side. Made in Italy. Introduced 1977. Importation began 1986; still imported.

Perf.: \$600 Exc.: \$500 VGood: \$400

### BERETTA MODEL 89 GOLD STANDARD PISTOL

Caliber: 22 LR, 8-shot magazine. Barrel: 6. Weight: 41 oz. Length: 9.5 overall. Stocks: Target-type walnut with thumbrest. Sights: Interchangeable blade front, fully adjustable rear. Features: Single action target pistol. Matte black, Brunton finish. Imported from Italy by Beretta U.S.A.

Perf.: \$525 Exc.: \$400 VGood: \$325



# HANDGUNS

## Beretta

**Model 90**  
**Model 92**  
**Model 92S (Second Issue)**  
**Model 92SB-P (Third Issue)**  
**Model 92SB-P Compact**  
**Model 92D**  
**Model 92FS**  
**M9 Special Edition Pistol**  
**Model 92F Compact**  
**Model 92FCM**  
**Model 92FS Centurion**  
**Model 92FS Stainless**  
**Model 92F-EL**  
**Model 96**  
**Model 96 Brigadier**



Beretta Model 90



Beretta Model 92



Beretta Model 92FS



Beretta M9 Special Edition Pistol



Beretta Model 96 Brigadier

### BERETTA MODEL 90

Semi-automatic; double action; 32 ACP; 8-shot magazine; 3 5/8" barrel; 6 3/4" overall length; fixed sights, matted rib on slide; chamber-loaded indicator; external hammer; stainless steel barrel; moulded plastic wrap-around grips; blued. Introduced 1969; dropped 1982.

Perf.: \$250 Exc.: \$200 VGood: \$150

### BERETTA MODEL 92

Semi-automatic, double action; 9mm Para.; 15-shot magazine; 5" barrel; 8 1/2" overall length; blued finish; fixed sights; plastic grips. Updated version of the Model 951. Introduced 1976; dropped 1981.

Perf.: \$600 Exc.: \$500 VGood: \$425

### BERETTA MODEL 92S (SECOND ISSUE)

Semi-automatic; double action; 9mm Para.; 15-shot magazine; 5" barrel; 8 1/2" overall length; fixed sights; plastic grips; blued finish. Variant of Model 92 with safety catch on side. Discontinued.

Perf.: \$550 Exc.: \$500 VGood: \$400

### BERETTA MODEL 92SB-P (THIRD ISSUE)

Automatic; double action; 9mm Para.; 16-shot magazine; 5" barrel; 8 1/2" overall length; weighs 34 1/2 oz.; blade front sight, windage-adjustable rear; black plastic or wood grips. Developed for U.S. Army pistol trials of 1979-1980. Introduced 1979; dropped 1985.

Perf.: \$450 Exc.: \$400 VGood: \$350

Wood grips

Perf.: \$500 Exc.: \$450 VGood: \$400

### Beretta Model 92SB-P Compact

Same specs as Model 92SB-P except 4 5/16" barrel, 14-shot magazine; plastic grips. Introduced 1977; dropped 1985.

Perf.: \$500 Exc.: \$450 VGood: \$400

Wood grips

Perf.: \$525 Exc.: \$475 VGood: \$425

### BERETTA MODEL 92D

Semi-automatic; double-action only; 9mm Para.; 10-shot magazine; 5" barrel; 8 1/2" overall length; weighs 34 oz.; bobbed hammer; no external safety; plastic grips; three-dot sights. Also offered with Trijicon sights. From Beretta U.S.A. Introduced 1992.

New: \$450 Perf.: \$400 Exc.: \$350

### BERETTA MODEL 92FS

Semi-automatic; double action; 9mm Para.; 15-shot magazine; 5" barrel; 8 1/2" overall length; matte black finish; squared triggerguard; grooved front backstraps; inertia firing pin; extractor acts as chamber loaded indicator; wood or plastic grips. Adopted 1985 as official U.S. military sidearm. Introduced 1984; still imported by Beretta USA.

Perf.: \$550 Exc.: \$500 VGood: \$450

Stainless steel barrel and slide (92F)

Perf.: \$600 Exc.: \$550 VGood: \$400

### Beretta M9 Special Edition Pistol

Copy of the U.S. M9 military pistol. Similar to the Model 92FS except has special M9 serial number range; one 15-round (pre-ban) magazine; dot-and-post sight system; special M9 military packaging; Army TM 9-1005-317-10 operator's manual; M9 Special Edition patch; certificate of authenticity; Bianchi M12 holster, M1025 magazine pouch, and M1015 web pistol belt. Introduced 1998. From Beretta U.S.A.

Perf.: \$700 Exc.: \$550 VGood: \$400

### Beretta Model 92F Compact

Same specs as Beretta Model 92FS except cut down frame; 4 3/8" barrel; 7 7/8" overall length; 13-shot magazine; weighs 31/2 oz.; Trijicon sights and wood grips optionally available. From Beretta U.S.A. Introduced 1989; no longer in production.

Perf.: \$500 Exc.: \$450 VGood: \$400

Wood grips

Perf.: \$525 Exc.: \$475 VGood: \$425

### Beretta Model 92FCM

Same specs as Model 92F Compact except thinner grip; straightline 8-shot magazine; weighs 31 oz.; 1 1/4" overall width; plastic grips. From Beretta U.S.A. Introduced 1989; no longer in production.

Perf.: \$500 Exc.: \$450 VGood: \$400

### Beretta Model 92FS Centurion

Same specs as Model 92 FS except 4 3/8" barrel shorter slide; Trijicon or three-dot sights; plastic or wood grips; 9mm Para. only. From Beretta U.S.A. Introduced 1992.

With plastic grips, three-dot sights

New: \$550 Perf.: \$500 Exc.: \$450

With wood grips

New: \$575 Perf.: \$525 Exc.: \$475

### Beretta Model 92FS Stainless

Same specs as Model 92FS except for stainless steel satin finish; groove in slide rail; larger hammer pin head; modified to meet special-use military specs. Introduced 1990; still produced.

Perf.: \$550 Exc.: \$500 VGood: \$450

### Beretta Model 92F-EL

Same specs as Model 92FS Stainless except gold trim on safety levers, magazine release, trigger and grip screws; gold inlaid Beretta logo top of barrel; P. Beretta signature inlaid in gold on slide; contoured walnut grips with Beretta logo engraved; high-polish blued finish on barrel, frame, slide. Introduced 1991.

Perf.: \$650 Exc.: \$600 VGood: \$500

### BERETTA MODEL 96

Semi-automatic; double action; 40 S&W; 10-shot magazine; 5" barrel; 8 1/2" overall length; weighs 34 oz.; ambidextrous triple safety with passive firing pin catch; slide safety/decocking lever; trigger bar disconnect; plastic grips; blued finish. Introduced 1992.

New: \$550 Perf.: \$500 Exc.: \$400

### Beretta Model 96 Brigadier

Same specs as Model 96 except removable front sight; reconfigured high slide wall profile; 10-shot magazine; three-dot sights system; 4 15/16" barrel; weighs 35 oz.; matte black Brunton finish. From Beretta U.S.A. Introduced 1995; still in production.

New: \$600 Perf.: \$550 Exc.: \$450

# HANDGUNS

## Beretta

- Model 1931
- Model 1934
- Model 1935
- Model 3032 Tomcat
- Model 8000 Cougar
- Model 8000 Cougar
- Model 8000D Cougar
- Model 8040 Cougar
- Model 8040D Cougar
- New Puma (See Beretta Model 70)
- New Sable (See Beretta Model 76)
- Panther (See Beretta Model 318)
- Plinker (See Beretta Model 948)

## Bergmann

- Model 1903 "Mars" Special
- Vest Pocket Models



Bergmann Vest Pocket



Beretta Model 1931

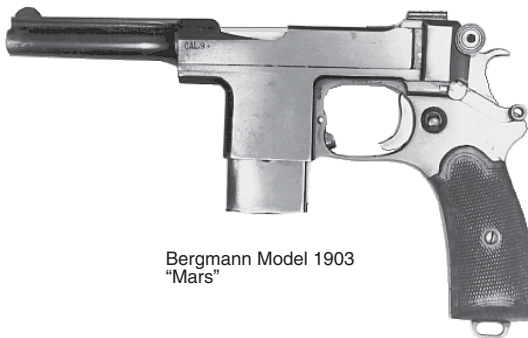

Bergmann Model 1903 "Mars"



Beretta Model 3032 Tomcat



Beretta Model 8000 Cougar

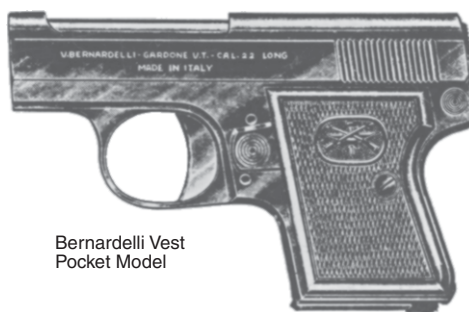

Bernardelli Vest Pocket Model



Bergmann Special

### BERETTA MODEL 1931

Semi-automatic; double-action; 32 ACP; 8-shot magazine; 3 1/2" barrel; 6" overall length; weighs 22 1/2 oz.; fixed sights; walnut grips; blued finish. Italian Navy issue bears medallion with "R/Anchor/M" emblem. Commercial issue has standard "PB" embossed black plastic grips.

Exc.: \$750 VGGood: \$600 Good: \$400

### BERETTA MODEL 1934

Semi-automatic; 380 ACP; 7-shot magazine; 3 3/8" barrel; 5 7/8" overall length; weighs 28 1/8 oz.; fixed sights; plastic grips; thumb safety; blued or chrome finish. Official Italian service sidearm in WWII; military versions marked "RE", "RA" or "RM" for the army, air force and navy respectively. Police versions marked "PS" on rear of frame. Wartime version lacks quality of commercial model. Introduced 1934; no longer legally importable; still in production.

Exc.: \$350 VGGood: \$300 Good: \$200

### BERETTA MODEL 1935

Semi-automatic; double action; 32 ACP; 7-shot magazine; 3 3/8" barrel; 5 7/8" overall length; fixed sights; plastic grips; thumb safety; blued or chrome finish. Italian service pistol during WWII; frame markings "RA" or "RM" on frame for the air force and navy respectively. Commercial version after 1945 known as Model 935.

Exc.: \$300 VGGood: \$275 Good: \$200

### BERETTA MODEL 3032 TOMCAT

Semi-automatic; 32 ACP, 7-shot magazine. Barrel: 2.45". Weight: 14.5 oz. Length: 5" overall. Stocks:

Checkered black plastic. Sights: Blade front, drift-adjustable rear. Features: Double action with exposed hammer; tip-up barrel for direct loading/unloading; thumb safety; polished or matte blue finish. Imported from Italy by Beretta U.S.A. Introduced 1996.

Perf.: \$200 Exc.: \$175 VGGood: \$150

### BERETTA MODEL 8000 COUGAR

Semi-automatic; double action; 9mm Para.; 10-shot magazine; 3 1/2" barrel; 7" overall length; weighs 33 1/2 oz.; textured composition grips; blade front sight, drift-adjustable rear; slide-mounted safety; exposed hammer; matte black Bruniton finish. Imported from Italy by Beretta U.S.A. Introduced 1994; still imported.

New: \$525 Perf.: \$450 Exc.: \$375

### Beretta Model 8000/8040 Mini Cougar

Similar to the Model 8000/8040 Cougar except has shorter grip frame and weighs 27.6 oz. Introduced 1998. Imported from Italy by Beretta U.S.A.

Perf.: \$600 Exc.: \$550 VGGood: \$400

### Beretta Model 8000D Cougar

Same specs as Model 8000 except double-action-only trigger mechanism. Imported from Italy by Beretta U.S.A. Introduced 1994; still imported.

New: \$550 Perf.: \$500 Exc.: \$400

### BERETTA MODEL 8040 COUGAR

Semi-automatic; double action; 40 S&W; 10-shot magazine; 3 1/2" barrel; 7" overall length; weighs 33 1/2 oz.; textured composition grips; blade front sight, drift-adjustable rear; slide-mounted safety; exposed hammer; matte black Bruniton finish. Imported from Italy by Beretta U.S.A. Introduced 1994; still imported.

New: \$575 Perf.: \$550 Exc.: \$525

### Beretta Model 8040D Cougar

Same specs as Model 8040 except double-action-only trigger mechanism. Imported from Italy by Beretta U.S.A. Introduced 1994; still imported.

New: \$550 Perf.: \$525 Exc.: \$500

### BERGMANN MODEL 1903 "MARS"

Semi-automatic; 9mm Bergmann-Bayard; 6-, 10-shot magazine; 4" barrel; 10" overall length; checkered wood grips. Marked "Bergmann Mars Pat. Brev. S.G.D.G." on locking block top. About 1,000 made in Germany before rights were sold to Pieper in Belgium where, with a few minor changes, it was made as the Bergmann-Bayard.

Exc.: \$5000 VGGood: \$3500 Good: \$2250

### BERGMANN SPECIAL

Semi-automatic; double action; 32 ACP; 8-shot magazine; 3 7/16" barrel; 6 3/16" overall length; checkered plastic wrap-around grips. Rare double-action competitor to Walther's Model PP, actually made by Menz but sold under Bergmann's name.

Exc.: \$1200 VGGood: \$850 Good: \$500

### BERGMANN VEST POCKET MODELS

Semi-automatic; 25 ACP; 6-, 9-shot magazine; 2 1/8" barrel; 4 3/4" overall length; checkered hard rubber or wood (rare) grips. Both conventional and one-hand-cocked ("Einhand") models later marketed under the Lignose name (see Lignose). Conventional

Exc.: \$300 VGGood: \$200 Good: \$125

"Einhand"

Exc.: \$400 VGGood: \$250 Good: \$150

32 or 380 "Einhand"

Catalogued but apparently never made.



# HANDGUNS

## Bernardelli

**Model USA**  
**P. One**  
**P. One Practical VG Pistol**  
**Standard**  
**Vest Pocket Model**

## Bersa

**Model 23**  
**Model 83**  
**Model 85**  
**Model 86**  
**Model 95 Series**  
**Model 223**  
**Model 224**  
**Model 225**



Bernardelli  
Model USA



Bersa Model 23



Bersa Model 225



Bersa Model 95  
Series



Bersa Model 83



Bersa Model 223

### BERNARDELLI MODEL USA

Semi-automatic; 22 LR, 380 ACP; 10-shot (22 LR), 7-shot (380 ACP) magazine; 3 1/2" barrel, 6 1/2" overall length; weighs 26 1/2 oz.; ramp front sight; fully-adjustable white-outline rear; checkered plastic stocks, thumbrest; serrated trigger; inertia-type firing pin; hammer-block safety; loaded chamber indicator. Made in Italy. Introduced 1989; was imported by Armsport and by Magnum Research, Inc.; no longer imported.

**Perf.:** \$350 **Exc.:** \$300 **VGood:** \$275

### BERNARDELLI P. ONE

Semi-automatic; double action; 9mm Para., 40 S&W; 16-shot (9mm), 10-shot (40 S&W) magazine; 4 7/8" barrel; 8 3/8" overall length; weighs 34 oz.; checkered black plastic grips; blade front sight, fully adjustable rear; three-dot system; forged steel frame and slide; full-length slide rails; reversible magazine release; thumb safety/decocker; squared triggerguard; blue/black finish. Imported from Italy by Armsport. Introduced 1994; no longer imported.

**Perf.:** \$550 **Exc.:** \$450 **VGood:** \$400

Chrome finish

**Perf.:** \$575 **Exc.:** \$500 **VGood:** \$450

### Bernardelli P. One Practical VB Pistol

Same specs as P. One except 9x21mm; two- or four-port compensator; straight trigger; micro-adjustable rear sight. Imported from Italy by Armsport. Introduced 1994.

**New:** \$1300 **Perf.:** \$1200 **Exc.:** \$1100

### BERNARDELLI STANDARD

Semi-automatic; 22 LR; 10-shot magazine; 6", 8", 10" barrel; 13" overall length (10" barrel); target sights; adjustable sight ramp; walnut target grips; blued. Simply the Pocket Model adapted for 22 LR cartridge. Introduced 1949; no longer imported.

**Perf.:** \$225 **Exc.:** \$200 **VGood:** \$175

### BERNARDELLI VEST POCKET MODEL

Semi-automatic; 25 ACP; 5-shot; 8-shot extension magazine also available; 2 1/8" barrel; 4 1/8" overall length; no sights, but sighting groove milled in slide; plastic grips; blued finish. Introduced 1948; U.S. importation dropped 1968.

**Exc.:** \$200 **VGood:** \$175 **Good:** \$135

### BERSA MODEL 23

Semi-automatic; double action; 22 LR; 10-shot magazine; 3 1/2" barrel; 6 1/2" overall length; weighs 24 1/2 oz.; walnut grips with stippled panels; blade front sight, notch windage-adjustable rear; three-dot system; firing pin, magazine safeties; blue or nickel finish. Made in Argentina; distributed by Eagle Imports, Inc. Introduced 1989; dropped 1994.

Blue finish

**Perf.:** \$200 **Exc.:** \$175 **VGood:** \$150

Nickel finish

**Perf.:** \$225 **Exc.:** \$200 **VGood:** \$175

### BERSA MODEL 83

Semi-automatic; double action; 380 ACP; 7-shot magazine; 3 1/2" barrel; 6 1/2" overall length; weighs 25 3/4 oz.; stippled walnut grips; blade front sight, notch windage-adjustable rear; three-dot system; firing pin, magazine safety systems; blue or nickel finish. Imported from Argentina; distributed by Eagle Imports, Inc. Introduced 1989; dropped 1994.

Blue finish

**Perf.:** \$200 **Exc.:** \$175 **VGood:** \$150

Nickel finish

**Perf.:** \$225 **Exc.:** \$200 **VGood:** \$175

### BERSA MODEL 85

Semi-automatic; double action; 380 ACP; 13-shot magazine; 3 1/2" barrel; 6 1/2" overall length; weighs 25 3/4 oz.; stippled walnut grips; blade front sight, notch windage-adjustable rear; three-dot system; firing pin, magazine safety systems; blue or nickel finish. Imported from Argentina; distributed by Eagle Imports, Inc. Introduced 1989; dropped 1994.

Blue finish

**Perf.:** \$250 **Exc.:** \$225 **VGood:** \$200

Nickel finish

**Perf.:** \$300 **Exc.:** \$275 **VGood:** \$250

### BERSA MODEL 86

Semi-automatic; double action; 380 ACP; 13-shot magazine; 3 1/2" barrel; 6 1/2" overall length; weighs 22 oz.; wrap-around textured rubber grips; blade front sight, windage-adjustable rear; three-dot system; firing pin, magazine safeties; combat-style triggerguard; matte blue or satin nickel finish. Imported from Argentina; distributed by Eagle Imports, Inc. Introduced 1992; dropped 1994.

Blue finish

**Perf.:** \$275 **Exc.:** \$225 **VGood:** \$175

Nickel finish

**Perf.:** \$300 **Exc.:** \$250 **VGood:** \$200

### BERSA MODEL 95 SERIES

Semi-automatic; double action; 380 ACP; 7-shot magazine; 3 1/2" barrel; 6 1/2" overall length; weighs 22 oz.; blade front sight, windage-adjustable rear; three-dot system; firing pin and magazine safeties; combat-style triggerguard; wrap-around textured rubber grips; matte blue or satin nickel. Imported from Argentina; distributed by Eagle Imports, Inc. Introduced 1992.

Matte blue finish

**New:** \$200 **Perf.:** \$175 **Exc.:** \$150

Satin nickel finish

**New:** \$225 **Perf.:** \$200 **Exc.:** \$175

### BERSA MODEL 223

Semi-automatic; double action; 22 LR; 11-shot magazine; 3 1/2" barrel; weighs 24 1/2 oz.; blade front sight, square-notch windage-adjustable rear; checkered target-type nylon stocks; thumbrest; blowback action; squared-off triggerguard; magazine safety; blued finish. Made in Argentina. Introduced 1984; dropped 1987.

**Perf.:** \$200 **Exc.:** \$175 **VGood:** \$150

### BERSA MODEL 224

Semi-automatic; single action; 22 LR; 11-shot magazine; 4" barrel; weighs 26 oz.; blade front sight, square-notch windage-adjustable rear; checkered target-type nylon stocks; thumbrest; blowback action; combat-type triggerguard; magazine safety; blued finish. Made in Argentina. Introduced 1984; no longer dropped 1987.

**Perf.:** \$200 **Exc.:** \$175 **VGood:** \$150

### BERSA MODEL 225

Semi-automatic; single action; 22 LR; 10-shot magazine; 5" barrel; weighs 26 oz.; blade front sight, square-notch windage-adjustable rear; checkered target-type nylon stocks; thumbrest; blowback action; combat-type triggerguard; magazine safety; blued finish. Made in Argentina. Introduced 1984; dropped 1987.

**Perf.:** \$175 **Exc.:** \$150 **VGood:** \$135

# HANDGUNS

## Browning

- 25 "Baby"
- 25 Lightweight
- 380 Standard
- 380 Renaissance
- BDA
- BDM
- Buck Mark Unlimited Match
- Buck Mark Varmint
- Challenger
- Challenger II
- Challenger III
- Challenger III Sporter
- Challenger Gold Model
- Challenger Renaissance Model
- Hi-Power
- Hi-Power 40 S&W Mark III
- Hi-Power Capitan
- Hi-Power HP-Practical



Browning 380 Standard



Browning BDA 380



Browning Hi-Power  
40 S&W Mark III



Browning Hi-Power  
HP-Practical



Browning Hi-Power



Browning Hi-Power  
Capitan

### BROWNING 25 "BABY"

Semi-automatic; 25 ACP; 6-shot magazine; 2 1/8" barrel; 4" overall length; fixed sights, hard rubber grips; blued finish. Introduced ca. 1936; dropped, not importable, 1968.

Perf.: \$350 Exc.: \$300 VGood: \$250

### Browning 25 Lightweight

Same specs as Browning 25 except chrome-plated; polyester pearl grips; alloy frame. Introduced 1954; dropped 1968.

Perf.: \$325 Exc.: \$275 VGood: \$250

### BROWNING 380 STANDARD

Semi-automatic; 380 ACP, 32 ACP; 9-shot magazine; 3 7/16" barrel; 6" overall length; pre-'68 models have fixed sights, later adjustable; hard rubber grips; blued finish. Redesigned 1968; dropped 1974. Last models had 4 1/2" barrel; 7" overall length.

Perf.: \$300 Exc.: \$250 VGood: \$200

### Browning 380 Renaissance

Same specs as standard Browning 380 Standard except chrome-plated finish; full engraving; polyester pearl grips. Introduced 1954; dropped 1981.

Perf.: \$900 Exc.: \$800 VGood: \$700

### BROWNING BDA

Semi-automatic; 9mm Para., 38 Super, 45 ACP; 9-shot magazine (9mm, 38 Super), 7-shot (45 ACP); 4 7/16" barrel; 7 13/16" overall length; fixed sights; plastic stocks; blued finish. Manufactured by Sauer; same as SIG-Sauer P220. Imported 1977 to 1981.

9mm, 45 ACP

Perf.: \$500 Exc.: \$450 VGood: \$350

38 Super

Perf.: \$600 Exc.: \$550 VGood: \$450

### BROWNING BDA 380

Semi-automatic; 380 Auto; 12-shot magazine; 3 13/16" barrel; 6 3/4" overall length; blade front sight, windage-adjustable rear; combination safety; de-cocking lever; inertia firing pin; uncheckered walnut grips. Manufactured in Italy. Introduced 1978; dropped 1997.

Perf.: \$400 Exc.: \$350 VGood: \$300

### BROWNING BDM

Semi-automatic; double action; 9mm Para.; 15-shot magazine; 4 3/4" barrel; 7 7/8" overall length; weighs 31 oz.; low-profile removable blade front sight, windage-adjustable rear; checkered black moulded composition grips, thumbrest on both sides; all-steel frame; matte black finish; two safety systems; mode selector for switching from DA auto to "revolver" mode. Introduced 1991; dropped 1997.

Perf.: \$450 Exc.: \$400 VGood: \$350

### Browning Buck Mark Unlimited Silhouette

Same as the Buck Mark Silhouette except has 14 heavy barrel. Conforms to IHMSA 15 maximum sight radius rule. Introduced 1991.

New: \$450 Per.: \$400 Exc.: \$350

### Browning Buck Mark Varmint

Same specs as Buck Mark except 9 7/8" heavy barrel; full-length scope base; no sights; black laminated wood stocks, optional forend; weighs 48 oz. Introduced 1987; still in production.

Perf.: \$300 Exc.: \$250 VGood: \$200

### BROWNING CHALLENGER

Semi-automatic; 22 LR; 10-shot magazine; 4 1/2", 6 3/4" barrels; overall length 11 7/16" (6 3/4" barrel); screw-adjustable rear sight, removable blade front; hand-checkered walnut grips; gold-plated trigger; blued finish. Introduced 1962; dropped 1974.

Perf.: \$350 Exc.: \$300 VGood: \$275

### Browning Challenger II

Same specs as Challenger except changed grip angle; impregnated hardwood stocks. Introduced 1975; replaced by Challenger III, 1982.

Perf.: \$225 Exc.: \$200 VGood: \$175

### Browning Challenger III

Same specs as Challenger except 5 1/2" heavy bull barrel; 9 1/2" overall length; weighs 35 oz.; lightweight alloy frame; improved sights; smooth impregnated hardwood grips; gold-plated trigger. Introduced 1982; dropped 1985.

Perf.: \$200 Exc.: \$175 VGood: \$165

### Browning Challenger III Sporter

Same specs as Challenger III except 6 3/4" barrel; 10 7/8" overall length; weighs 29 oz.; all-steel construction; blade ramped front sight, screw-adjustable rear, drift-adjustable front. Introduced 1982; dropped 1985.

Perf.: \$200 Exc.: \$175 VGood: \$165

### Browning Challenger Gold Model

Same specs as Challenger except gold wire inlays in metal; figured hand-carved, checkered walnut grips. Introduced 1971; dropped 1974.

Perf.: \$1200 Exc.: \$1000 VGood: \$750

### Browning Challenger Renaissance Model

Same specs as Challenger except satin nickel finish; full engraving; top-grade hand-carved, figured walnut grips. Introduced 1971; dropped 1974.

Perf.: \$1200 Exc.: \$1000 VGood: \$750

### BROWNING HI-POWER

Semi-automatic; 9mm Para.; 13-shot magazine; 4 5/8" barrel; fixed sights; checkered walnut (pre-1986) or moulded grips; ambidextrous safety added in '80s; blued finish. Introduced 1954; still in production.

Perf.: \$500 Exc.: \$450 VGood: \$350

### Browning Hi-Power 40 S&W Mark III

Same specs as standard Hi-Power except 40 S&W; 10-shot magazine; weighs 35 oz.; 4 3/4" barrel; matte blue finish; low profile front sight blade, drift-adjustable rear; ambidextrous safety; moulded polyamide grips with thumbrest. Imported from Belgium by Browning. Introduced 1993; still imported.

New: \$500 Perf.: \$450 Exc.: \$350

### Browning Hi-Power Capitan

Same specs as standard Hi-Power except adjustable tangent rear sight authentic to early-production model; Commander-style hammer; checkered walnut grips; polished blue finish. Imported from Belgium by Browning. Reintroduced 1993; still imported.

New: \$550 Perf.: \$500 Exc.: \$400

### Browning Hi-Power HP-Practical

Same specs as standard Hi-Power except silver-chromed frame, blued slide; wrap-around Pachmayr rubber grips; round-style serrated hammer; removable front sight, windage-adjustable rear. Introduced 1981; still in production.

Perf.: \$600 Exc.: \$550 VGood: \$450



# HANDGUNS

## Charter Arms

**Bulldog  
Bulldog Pug  
Bulldog Tracker  
Explorer II  
Lady On Duty  
Magnum Pug  
Model 40  
Model 79K  
Off-Duty  
Pathfinder  
Pit Bull  
Police Bulldog  
Police Bulldog Stainless**



Charter Arms  
Bulldog



Charter Arms  
Police Bulldog



Charter Arms  
Magnum Pug



Charter Arms  
Pit Bull



Charter Arms  
Off-Duty



Charter Arms  
Model 40



Charter Arms Pathfinder

### CHARTER ARMS BULLDOG

Revolver; double action; 44 Spl.; 5-shot cylinder; 2 1/2", 3" barrel; 7 1/2" overall length; weighs 19 oz.; square notch fixed rear sight, Patridge-type front; checkered walnut or neoprene grips; chrome-moly steel frame; wide trigger and hammer, or spurless pocket hammer; blued or stainless finish. Introduced 1973; dropped 1996.

**Perf.:** \$200 **Exc.:** \$175 **VGGood:** \$150

Stainless Bulldog

**Perf.:** \$175 **Exc.:** \$165 **VGGood:** \$135

### Charter Arms Bulldog Pug

Same specs as Bulldog except 2 1/2" shrouded barrel; 7 1/4" overall length; weighs 19 oz.; notch rear sight, ramp front; wide trigger and hammer spur; shrouded ejector rod; blued or stainless steel finish. Introduced 1986; reintroduced 1993; dropped 1993.

**Perf.:** \$225 **Exc.:** \$200 **VGGood:** \$165

Stainless Bulldog Pug

**Perf.:** \$225 **Exc.:** \$200 **VGGood:** \$175

### Charter Arms Bulldog Tracker

Same specs as Bulldog except 357 Mag.; 2 1/2", 4", or 6" bull barrel; adjustable rear sight, ramp front; checkered walnut or Bulldog-style neoprene grips; square butt on 4" and 6" models; blued finish. Introduced 1986.

**Perf.:** \$175 **Exc.:** \$150 **VGGood:** \$135

### CHARTER ARMS EXPLORER II

Semi-automatic; 22 LR; 8-shot magazine; 6", 8" or 10" barrel; 15 1/2" overall length; blade front sight, open elevation-adjustable rear; serrated simulated walnut

stocks; action adapted from Explorer AR-7 carbine; black, camo, gold or silver finish. Introduced 1980; discontinued 1986.

**Perf.:** \$100 **Exc.:** \$85 **VGGood:** \$75

### CHARTER ARMS LADY ON DUTY

Revolver; double action; 22 LR, 22 WMR, 38 Spl.; 6-shot (22LR, 22 WMR), 5-shot (38 Spl.); 2" barrel; 6 1/4" overall length; weighs 17 oz.; rosewood-color checkered plastic grips; ramp-style front sight, fixed rear; comes with lockable plastic case, trigger lock; choice of spur, pocket or double-action hammer; blue or nickel finish. Made in U.S. by Charco, Inc. Introduced 1995; dropped 1996.

**New:** \$175 **Perf.:** \$165 **Exc.:** \$150

### CHARTER ARMS MAGNUM PUG

Revolver; double action; 357 Mag.; 5-shot; 2 1/4" barrel; weighs 18 oz.; Bulldog or neoprene combat grips; ramp-style front sight, fixed rear; fully shrouded barrel; pocket or spur hammer; blue finish. Made in U.S. by Charco, Inc. Introduced 1995; dropped 1996.

**New:** \$200 **Perf.:** \$175 **Exc.:** \$165

### CHARTER ARMS MODEL 40

Semi-automatic; double action; 22 LR; 8-shot; 3 5/16" barrel; weighs 2 11/2 oz.; fixed sights; stainless steel finish. Introduced 1984; discontinued 1986.

**Perf.:** \$250 **Exc.:** \$200 **VGGood:** \$185

### CHARTER ARMS MODEL 79K

Semi-automatic; double action; 32 ACP, 380 ACP; 7-shot; 3 5/8" barrel; 6 1/2" overall length; weighs 24 1/2 oz.; fixed sights; hammer block; firing pin, magazine safeties; stainless steel finish. Imported from West Germany. Introduced 1984; no longer imported.

**Perf.:** \$300 **Exc.:** \$275 **VGGood:** \$225

### CHARTER ARMS OFF-DUTY

Revolver; double action; 22 LR, 38 Spl.; 5-shot (38 Spl.); 2" barrel; 6 3/4" overall length; fixed sights; choice of smooth or checkered walnut, neoprene grips; all steel; matte black finish. Introduced 1984; reintroduced 1993; dropped 1996.

**New:** \$165 **Perf.:** \$150 **Exc.:** \$135

Stainless Off-Duty

**New:** \$225 **Perf.:** \$200 **Exc.:** \$175

### CHARTER ARMS PATHFINDER

Revolver; double action; 22 LR, 22 WMR; 6-shot; 2", 3", 6" barrels; 7 3/8" overall length; weighs 18 1/2 oz.; adjustable rear sight, ramp front; round butt; wide hammer spur and trigger; blued finish. Introduced 1971; dropped 1990.

**Perf.:** \$175 **Exc.:** \$165 **VGGood:** \$150

Square butt Pathfinder

**Perf.:** \$175 **Exc.:** \$165 **VGGood:** \$150

Stainless Pathfinder with 31/2" shrouded barrel

**Perf.:** \$175 **Exc.:** \$165 **VGGood:** \$150

### CHARTER ARMS PIT BULL

Revolver; double action; 9mm Federal, 38 Spl., 357 Mag.; 5-shot; 2 1/2", 3 1/2", 4" barrels; 7 1/4" overall length; weighs 24 1/2 oz. (2 1/2" barrel); blade front sight, fixed rear on 2 1/2", adjustable on others; checkered neoprene grips; blued finish. Introduced 1989; discontinued 1991.

**Perf.:** \$225 **Exc.:** \$200 **VGGood:** \$165

Stainless Pit Bull

**Perf.:** \$225 **Exc.:** \$200 **VGGood:** \$175

### CHARTER ARMS POLICE BULLDOG

Revolver; double action; 32 H&R, 38 Spl., 44 Spl.; 5-shot (44) or 6-shot; 3 1/2", 4" barrel; fixed sights; neoprene grips; square butt (44 Spl.); blued finish. Introduced 1976; dropped 1991.

**Perf.:** \$200 **Exc.:** \$175 **VGGood:** \$150

### Charter Arms Police Bulldog Stainless

Same specs as Police Bulldog except also offered in 357 Mag. (5-shot); shrouded barrel; square butt; stainless finish.

**Perf.:** \$200 **Exc.:** \$175 **VGGood:** \$150

# HANDGUNS

## Colt Semi-Automatic Pistols

**Combat Elite MKIV Series 80**  
**Combat Government MKIV Series 70**  
**Combat Government MKIV Series 80**  
**Commander Lightweight MKIV Series 80**  
**Defender**  
**Delta Elite**  
**Delta Gold Cup**  
**Double Eagle Combat Commander MKII Series 90**  
**Double Eagle MKII Series 90**  
**Combat Commander MKIV Series 70**  
**Double Eagle Officer's Model MKIV Series 90**



Colt Delta Elite



Colt Double Eagle  
Combat Commander  
MKII Series 90



Colt Combat Commander  
MKIV Series 70



Colt Defender



Colt Combat Elite  
MKIV Series 80

### COLT COMBAT ELITE MKIV SERIES 80

Semi-automatic; single action; 38 Super, 45 ACP; 7-, 8-shot magazine; 5" barrel; 8 1/2" overall length; weighs 39 oz.; high profile sights with 3-dot system; checkered rubber combat grips; stainless steel frame; ordnance steel slide, internal parts; beveled magazine well; extended grip safety. Introduced, 1986; still in production.

Perf.: \$700 Exc.: \$600 VGood: \$500

### COLT COMBAT GOVERNMENT MKIV SERIES 70

Semi-automatic; single action; 45 ACP; 8-shot magazine; 5" barrel; 8 3/8" overall length; weighs 40 oz. Similar to Government Model except higher undercut front sight, white outlined rear; flat mainspring housing; longer trigger; beveled magazine well; angled ejection port; Colt/Pachmayr wrap-around grips; internal firing pin safety. Introduced 1973; dropped 1983.

Perf.: \$650 Exc.: \$550 VGood: \$450

### COLT COMBAT GOVERNMENT MKIV SERIES 80

Semi-automatic; single action; 45 ACP; 5-shot magazine; 5" barrel; 8 1/2" overall length; weighs 39 oz. Similar to Combat Government MKIV Series 70 with higher undercut front sight, white outlined rear; flat mainspring housing; longer trigger beveled magazine well; angled ejection port; Colt/Pachmayr wrap-around grips; internal firing pin safety; 45 with blue, satin or stainless finish; 9mm, 38 blue only. Introduced 1983; dropped 1996.

Perf.: \$600 Exc.: \$500 VGood: \$400

### COLT COMMANDER LIGHTWEIGHT MKIV SERIES 80

Semi-automatic; 45 ACP, 38 Super, 9mm Para.; 4 1/4" barrel, 8" overall length; 7-shot magazine (45 ACP), 9-shot (38 Super, 9mm); weighs 26 1/2 oz.; basic design of Government Model auto, but of lightweight alloy, reducing weight; checkered walnut grips; fixed sights; rounded hammer spur; blued, nickel finish. Introduced 1983; still in production.

Perf.: \$600 Exc.: \$500 VGood: \$400

### COLT DEFENDER

Semi-automatic; 45 ACP, 7-shot magazine. Barrel: 3". Weight: 22-1/2 oz. Length: 6-3/4" overall. Stocks: Pebble-finish rubber wraparound with finger grooves. Sights: White dot front, snag-free Colt competition rear. Features: Stainless finish; aluminum frame; combat-style hammer; Hi Ride grip safety, extended manual safety, magazine disconnect safety. Introduced 1998.

Perf.: \$600 Exc.: \$500 VGood: \$400

### COLT DELTA ELITE

Semi-automatic; 10mm Auto; 8-shot; 5" barrel; 8 1/2" overall length; weighs 38 oz.; same general design as Government Model; 3-dot high profile combat sights; rubber combat stocks; internal firing pin safety; new recoil spring/buffer system; blued or matte stainless finish. Introduced 1987; still in production.

Perf.: \$700 Exc.: \$550 VGood: \$450

Matte stainless

Perf.: \$750 Exc.: \$600 VGood: \$500

### Colt Delta Gold Cup

Same specs as Delta Elite except Accro adjustable rear sight; adjustable trigger; wrap-around grips; stainless steel finish. Introduced 1989; still in production.

Perf.: \$850 Exc.: \$700 VGood: \$600

### COLT DOUBLE EAGLE COMBAT COMMANDER MKII SERIES 90

Semi-automatic; double action; 40 S&W, 45 ACP; 8-shot magazine; 4 1/4" barrel; 7 3/4" overall length; weighs 36 oz.; blade front sight, windage-adjustable rear; 3-dot system; Colt Accro adjustable sight optional; stainless steel; checkered, curved extended triggerguard; wide steel trigger; decocking lever; traditional magazine release; beveled magazine well; grooved frontstrap; extended grip guard; combat-type hammer. Introduced 1991; still in production in 45 ACP.

Perf.: \$600 Exc.: \$500 VGood: \$400

Accro sight

Perf.: \$650 Exc.: \$550 VGood: \$450

### COLT DOUBLE EAGLE MKII SERIES 90

Semi-automatic; double action; 45 ACP; 8-shot magazine; 4 1/2", 5" barrel; 8 1/2" overall length; weighs 39

oz.; blade front sight, windage-adjustable rear; black checkered thermoplastic grips; stainless steel construction; matte finish; extended triggerguard; decocking lever; grooved frontstrap; beveled magazine well; rounded hammer; extended grip guard. Introduced 1989; dropped 1996.

Perf.: \$600 Exc.: \$500 VGood: \$400

Exc.: \$800 VGood: \$600 Good: \$400

9mm

Exc.: \$600 VGood: \$450 Good: \$300

### COLT COMBAT COMMANDER MKIV SERIES 70

Semi-automatic; single action; 45 ACP, 38 Super, 9mm Para.; 7-shot (45 ACP), 9-shot (38 Super, 9mm); 4 1/4" barrel; 7 7/8" overall length; weighs 36 oz.; fixed blade front sight; square notch rear; all steel frame; grooved trigger; lanyard-style hammer; checkered walnut grips; blue or nickel finish. Introduced, 1970; dropped 1983.

Perf.: \$750 Exc.: \$600 VGood: \$400

Nickel finish

Perf.: \$800 Exc.: \$650 VGood: \$450

### COLT DOUBLE EAGLE OFFICER'S MODEL MKIV SERIES 90

Semi-automatic; double action; 45 ACP; 8-shot magazine; 3 1/2" barrel; 7 1/4" overall length; weighs 35 oz.; stainless steel construction; blade front, windage-adjustable rear sight with 3-dot system; black checkered thermoplastic grips; matte finish; extended trigger guard; decocking lever; grooved frontstrap; beveled magazine well; rounded hammer; extended grip guard. Introduced 1989; dropped 1996.

Perf.: \$600 Exc.: \$500 VGood: \$400

Lightweight model (25 oz.)

Perf.: \$600 Exc.: \$500 VGood: \$400



# HANDGUNS

## Colt Semi-Automatic Pistols

Gold Cup National Match MKIII  
 Gold Cup National Match MKIV Series 70  
 Gold Cup National Match MKIV Series 80  
 Gold Cup Trophy Government Model MKIV Series 70  
 Government Model MKIV Series 80  
 Government Model 380 MKIV Series 80  
 Huntsman, Targetsman Junior  
 Model 1900  
 Model 1900 Army



Colt Huntsman



Colt Gold Cup National Match MKIV Series 80



Colt Junior



Colt Government Model MKIV Series 80



Colt Government Model 380 MKIV Series 80



Colt Gold Cup Trophy

### COLT GOLD CUP NATIONAL MATCH MKIII

Semi-automatic; 45 ACP, 38 Spl.; 5" match barrel; 8 1/2" overall length; weighs 37 oz.; Patridge front sight, Colt Elliason adjustable rear; arched or flat housing; wide, grooved trigger with adjustable stop; ribbed top slide; hand-fitted with improved ejection port. Introduced 1959; dropped 1970.

45 ACP  
 Exc.: \$1000 VGGood: \$800 Good: \$650  
 38 Spl.  
 Exc.: \$1100 VGGood: \$850 Good: \$700

### COLT GOLD CUP NATIONAL MATCH MKIV SERIES 70

Semi-automatic; 45 ACP; 7-shot magazine; 5" barrel; 8 3/8" overall length; weighs 38 1/2 oz.; undercut front sight, Colt Elliason adjustable rear; match-grade barrel, bushing; long, wide grooved trigger; flat grip housing; hand-fitted slide; checkered walnut grips; blued finish. Introduced 1970; dropped 1983.

Exc.: \$850 VGGood: \$750 Good: \$600

### COLT GOLD CUP NATIONAL MATCH MKIV SERIES 80

Semi-automatic; single action; 45 ACP; 8-shot magazine; 5" barrel; 8 1/2" overall length; weighs 39 oz.; Patridge front sight, Colt-Elliason adjustable rear; match-grade barrel, bushing; long, wide trigger adjustable trigger stop; flat mainspring housing; hand-fitted slide; wider ejection port; checkered walnut grips; blue, stainless, bright stainless finish. Introduced 1983; dropped 1996.

Perf.: \$700 Exc.: \$600 VGGood: \$500  
 Stainless finish  
 Perf.: \$750 Exc.: \$650 VGGood: \$550  
 Bright stainless  
 Perf.: \$800 Exc.: \$700 VGGood: \$600

### COLT GOLD CUP TROPHY

Semi-automatic; 45 ACP, 8-shot magazine. Barrel: 5, with new design bushing. Weight: 39 oz. Length: 8-1/2. Stocks: Checkered rubber composite with silver-plated medallion. Sights: Patridge-style front, Colt-Elliason rear adjustable for windage and elevation, sight radius 6-3/4. Features: Arched or flat housing; wide, grooved trigger with adjustable stop; ribbed-top slide, hand fitted, with improved ejection port.

Perf.: \$900 Exc.: \$800 VGGood: \$600

### COLT GOVERNMENT MODEL MKIV SERIES 70

Semi-automatic; single action; 45 ACP, 38 Super, 9mm Para.; 7-shot magazine; 5" barrel; 8 3/8" overall length; weighs 40 oz; ramp front sight, fixed square notch rear; grip, thumb safeties; grooved trigger; accurizor barrel, bushing; blue or nickel (45 only) finish. Redesigned, redesignated Colt Model 1911A1. Introduced 1970; dropped 1983.

Perf.: \$500 Exc.: \$450 VGGood: \$400  
 Nickel finish  
 Perf.: \$550 Exc.: \$500 VGGood: \$400

### COLT GOVERNMENT MODEL MKIV SERIES 80

Semi-automatic; single action; 45 ACP, 38 Super, 9mm Para.; 7-, 8-shot magazine; 5" barrel; 8 1/2" overall length; weighs 38 oz.; ramp front sight, fixed square notch rear; grip and thumb safeties; internal firing pin safety; grooved trigger; accurizor barrel bushing; checkered walnut grips; blue, nickel, satin nickel, bright stainless, stainless steel finish. Introduced 1983; still in production.

Blue, nickel, satin nickel finish  
 Perf.: \$600 Exc.: \$500 VGGood: \$425  
 Stainless steel, bright stainless finish  
 Perf.: \$650 Exc.: \$550 VGGood: \$475

### COLT GOVERNMENT MODEL 380 MKIV SERIES 80

Semi-automatic; 380 ACP; 7-shot magazine; 3" barrel; 6" overall length; weighs 21 3/4 oz.; checkered composition stocks; ramp front sight, fixed square-notch rear; thumb and internal firing pin safeties; blue, nickel, satin nickel or stainless steel finish. Introduced 1983; dropped 1997.

Perf.: \$375 Exc.: \$325 VGGood: \$275  
 Nickel, satin nickel finish  
 Perf.: \$400 Exc.: \$325 VGGood: \$275  
 Stainless steel finish  
 Perf.: \$425 Exc.: \$375 VGGood: \$325

### COLT HUNTSMAN, TARGETSMAN

Semi-automatic; 22 LR; 4 1/2", 6" barrel; 9" overall length; checkered plastic grips; no hold-open device; fixed sights (Huntsman), adjustable sights and 6" barrel only (Targetsman). Introduced 1955; dropped 1977.

Huntsman  
 Exc.: \$350 VGGood: \$275 Good: \$225  
 Targetsman  
 Exc.: \$450 VGGood: \$350 Good: \$275

### COLT JUNIOR

Semi-automatic; 22 Short, 25 ACP; 6-shot magazine; 2 1/4" barrel; 4 3/8" overall length; exposed hammer with round spur; checkered walnut stocks; fixed sights; blued. Initially produced in Spain by Astra, with early versions having Spanish markings as well as Colt identity; parts were assembled in U.S., sans Spanish identification after GCA '68 import ban. Introduced 1968; dropped 1973.

Spanish model  
 Exc.: \$300 VGGood: \$250 Good: \$200  
 U.S.-made model  
 Exc.: \$325 VGGood: \$275 Good: \$200

### COLT MODEL 1900

Semi-automatic; 38 ACP; 7-shot magazine; 6" barrel; 9" overall length; spur hammer; plain walnut stocks; blued finish. Dangerous to fire modern high-velocity ammo. Was made in several variations. Introduced 1900; dropped 1903. Collector value.

Standard model  
 Exc.: \$5000 VGGood: \$3500 Good: \$2500  
 Altered sight safety  
 Exc.: \$2200 VGGood: \$1400 Good: \$1000

### Colt Model 1900 Army

Same specs as Model 1900. Marked U.S. on left side of triggerguard bow, with inspector markings.  
 Exc.: \$7500 VGGood: \$5500 Good: \$4500

# HANDGUNS

## Colt Semi-Automatic Pistols

- Model 1911 British 455
- Model 1911 Military
- Model 1911 Russian
- Model 1911A1
- Colt National Match
- Super 38
- Super 38 National Match
- Model 1991A1
- Model 1991A1 Commander
- Model 1991A1 Compact
- Mustang



Colt National Match



Colt National Match



Colt Model 1911 Military (Springfield Armory)



Colt 1911A1



Colt Mustang

### Colt Model 1911 British 455

Same specs as standard model but carries "Calibre 455" on right side of slide and may have broad arrow British ordnance stamp; made 1915-1916; 11,000 manufactured. Collector value.

Exc.: \$2000 VGood: \$1600 Good: \$1250

### Colt Model 1911 Military

Same specs as the civilian version except serial numbers not preceded by the letter C; produced from 1912 to 1924; bright blue finish, early production; duller blue during war. Parkerized finish indicates post-war reworking and commands lesser value than original blue finish. Navy issue marked "Model of 1911 U.S. Navy" on slide.

#### Standard

Exc.: \$2000 VGood: \$1400 Good: \$850

#### U.S. Navy marked

Exc.: \$3750 VGood: \$2500 Good: \$1800

#### Remington-UMC (21,676)

Exc.: \$2200 VGood: \$1700 Good: \$950

#### Springfield Armory (25,767)

Exc.: \$2500 VGood: \$2000 Good: \$950

### Colt Model 1911 Russian

Same specs as the standard version except Russian characters ANGLIOZAKAZIVAT stamped on the slide. All were in 45 ACP, carrying serial numbers C-50000 through C-85000. This is an exceedingly rare collector item.

Exc.: \$3000 VGood: \$2250 Good: \$1650

### COLT MODEL 1911A1

Semi-automatic; single action; 45 ACP, 7-shot magazine; 5" barrel; 8 1/2" overall length; weighs 38 oz.; checkered walnut (early production) or brown composition (military version) grips; ramped blade front sight, fixed high-profile square notch rear; Parkerized finish. Same specs as Model 1911 except longer grip safety spur; arched mainspring housing; finger relief cuts in frame behind trigger; plastic grips. During WWII other firms produced the 1911A1 under Colt license, including Remington-Rand, Ithaca Gun Co., and Union Switch & Signal Co. These government models bear imprint of licensee on slide. In 1970, this model was redesigned and redesignated as Government Model MKIV Series 70; approximately 850 1911A1 guns were equipped with split-collet barrel bushing and BB prefix serial number which adds to the value. Modern version (marked "Colt M1911A1(tm)") continues serial number range used on original G.I. 1911A1 guns and comes with one magazine and moulded carrying case. Introduced 1923; still produced.

#### Commercial model ("C" s/n)

Exc.: \$850 VGood: \$700 Good: \$500

#### BB s/n prefix

Exc.: \$950 VGood: \$800 Good: \$600

#### Military model

Exc.: \$950 VGood: \$650 Good: \$500

#### Singer Mfg. Co. (500)

Exc.: \$15,000 VGood: \$12,000 Good: \$8500

#### Union Switch & Signal (55,000)

Exc.: \$1250 VGood: \$850 Good: \$700

#### Remington-Rand (1,000,000)

Exc.: \$700 VGood: \$600 Good: \$500

#### Ithaca Gun Co. (370,000)

Exc.: \$700 VGood: \$600 Good: \$500

#### 45/22 conversion unit

Exc.: \$650 VGood: \$550 Good: \$400

#### 22/45 conversion unit

Exc.: \$1500 VGood: \$1000 Good: \$800

### COLT NATIONAL MATCH

Semi-automatic; 45 ACP; 7-shot; 5" barrel; 8 1/2" overall length; weighs 37 oz.; adjustable rear, ramp front target sight; match-grade barrel; hand-honed action. Also available with fixed sights. Introduced 1933; dropped 1941.

#### Fixed sights

Exc.: \$2750 VGood: \$2000 Good: \$1600

#### Target sights

Exc.: \$3250 VGood: \$2500 Good: \$1850

### COLT SUPER 38

Semi-automatic; double action; 38 Colt Super; 9-shot magazine; fixed sights standard, adjustable rear sights available. Same frame as 1911 commercial until 1970. Introduced in 1929. In 1937, the design of the firing pin, safety, hammer, etc. were changed and the model renamed the New Style Super 38. Still in production as Government Model Mark IV/Series 80.

Exc.: \$750 VGood: \$600 Good: \$500

#### Pra-WWI

Exc.: \$2500 VGood: \$2000 Good: \$1500

#### Colt Super 38 National Match

Same specs as Colt Super 38 except hand-honed action; adjustable target sights; match-grade barrel. Manufactured from 1935 to 1941.

Exc.: \$4500 VGood: \$3500 Good: \$2500

### COLT MODEL 1991A1

Semi-automatic; 45 ACP; 7-shot magazine; 5" barrel; 8 1/2" overall length; weighs 38 oz.; ramped blade front sight, fixed square notch high-profile rear; checkered black composition grips; Parkerized finish; continuation of serial number range used on original G.I. 1911A1 guns. Introduced 1991; still in production.

New: \$500 Perf.: \$450 Exc.: \$400

### Colt Model 1991A1 Commander

Same specs as the Model 1991A1 except 4 1/4" barrel; Parkerized finish. Comes in moulded case. Made in U.S. by Colt's Mfg. Co. Introduced 1993; still in production.

New: \$500 Perf.: \$450 Exc.: \$400

### Colt Model 1991A1 Compact

Same specs as the Model 1991A1 except 3 1/2" barrel; 7" overall length; 3/8" shorter height. Comes with one 6-shot magazine, moulded case. Made in U.S. by Colt's Mfg. Co. Introduced 1993; still produced.

New: \$500 Perf.: \$450 Exc.: \$400

### COLT MUSTANG

Semi-automatic; 380 ACP; 5-, 6-shot magazine; 2 3/4" barrel; 5 1/2" overall length; weighs 18 1/2 oz.; steel frame; stainless, blued or nickel finish. Similar to Colt Government Model 380. Introduced 1987; dropped 1997.

Perf.: \$350 Exc.: \$300 VGood: \$250

#### Nickel finish

Perf.: \$375 Exc.: \$325 VGood: \$275

#### Stainless finish

Perf.: \$375 Exc.: \$325 VGood: \$275



# HANDGUNS

## Colt Revolvers & Single Shots

Detective Special (Second Issue)  
 Detective Special (Third Issue)  
 Detective Special (Fourth Issue)  
 Diamondback  
 Frontier Scout  
 Frontier Scout Buntline  
 King Cobra  
 Magnum Carry  
 Lawman MKIII  
 Lawman MKV  
 Metropolitan MKIII  
 Model 1877 Lightning  
 Model 1877 Thunderer  
 Model 1878 Frontier



Colt Detective Special (Second Issue)



Colt Detective Special (Third Issue)



Colt Diamondback



Colt Frontier Scout



Colt Detective Special (Fourth Issue)



Colt National Match



Colt Lawman MKIII

### COLT DETECTIVE SPECIAL (FIRST ISSUE)

Revolver; double action; 38 Spl.; 6-shot swing-out cylinder; 2", 3" barrels; 6 3/4" overall length; rounded butt introduced in 1934; blue or nickel finish. Introduced 1927; dropped 1936.

Exc.: \$575 VGood: \$475 Good: \$350

Nickel finish

Exc.: \$600 VGood: \$500 Good: \$375

### Colt Detective Special (Second Issue)

Same specs as First Issue except 32 New Police, 38 New Police; heavier barrel; integral protective shroud enclosing ejector rod; frame, sideplate, cylinder, barrel, internal parts of high-tensile alloy steel; plastic or walnut Bulldog-type grips; fixed rear sight; notch milled in topstrap, serrated ramp front; checkered hammer spur; blue or nickel finish. Introduced 1947; dropped 1972.

Perf.: \$450 Exc.: \$350 VGood: \$275

Nickel finish

Perf.: \$475 Exc.: \$375 VGood: \$300

### Colt Detective Special (Third Issue)

Same specs as Second Issue except 38 Spl.; shrouded ejector rod; wrap-around walnut grips. Introduced 1973; dropped 1986.

Perf.: \$400 Exc.: \$325 VGood: \$275

### Colt Detective Special (Fourth Issue)

Same specs as Third Issue except 2" barrel only; weighs 22 oz.; 6 5/8" overall length; black composition grips; ramp front sight, fixed square notch rear; glare-proof sights; grooved trigger; Colt blue finish. Made in U.S. by Colt's Mfg. Reintroduced 1993; still produced.

New: \$350 Perf.: \$290 Exc.: \$250

### COLT DIAMONDBACK

Revolver; double action; 38 Spl., 22 LR; 6-shot swing-out cylinder; 2 1/2", 4" (22 LR), 6" barrel; vent-rib barrel; scaled-down version of Python; target-type adjustable rear sight, ramp front; full checkered walnut grips; integral rounded rib beneath barrel

shrouds, ejector rod; broad checkered hammer spur. Introduced 1966; dropped 1986.

Perf.: \$450 Exc.: \$350 VGood: \$275

Nickel finish

Perf.: \$500 Exc.: \$400 VGood: \$325

22 LR

Perf.: \$525 Exc.: \$425 VGood: \$350

### COLT FRONTIER SCOUT

Revolver; single action; 22 LR, 22 Long, 22 Short; interchangeable cylinder for 22 WMR; 4 1/2" barrel; 9 15/16" overall length; originally introduced with alloy frame; steel frame, blue finish introduced in 1959; fixed sights; plastic or wooden grips. Introduced 1958; dropped 1971.

Alloy frame

Perf.: \$425 Exc.: \$375 VGood: \$225

Blue finish, plastic grips

Perf.: \$600 Exc.: \$400 VGood: \$300

Nickel finish, wood grips

Perf.: \$450 Exc.: \$375 VGood: \$250

With 22 WMR cylinder

Perf.: \$450 Exc.: \$400 VGood: \$275

### Colt Frontier Scout Buntline

Same specs as Frontier Scout except 9 1/2" barrel. Introduced 1959; dropped 1971.

Perf.: \$500 Exc.: \$425 VGood: \$325

### COLT KING COBRA

Revolver; double action; 357 Mag.; 6-shot cylinder; 2 1/2", 4", 6" barrels; 9" overall length (4" barrel); weighs 42 oz.; adjustable white outline rear sight, red insert ramp front; full-length contoured ejector rod housing, barrel rib; matte finish; stainless steel construction. Introduced 1986; still in production.

Perf.: \$350 Exc.: \$250 VGood: \$225

### COLT MAGNUM CARRY REVOLVER

Caliber: 357 Mag., 6-shot. Barrel: 2". Weight: 21 oz. Length: NA. Stocks: Combat-style rubber. Sights: Ramp front, fixed notch rear. Features: Stainless steel construction. Smooth combat trigger. Introduced 1998.

New: \$400 Perf.: \$350 Exc.: \$250

### COLT LAWMAN MKIII

Revolver; double action; 357 Mag.; also chambers 38 Spl.; 2", 4" barrels; 9 3/8" overall length (4" barrel); choice of square, round butt walnut grips; fixed sights; blued, nickel finish. Introduced 1969; dropped 1983.

Perf.: \$300 Exc.: \$225 VGood: \$175

Nickel finish

Perf.: \$325 Exc.: \$250 VGood: \$200

### Colt Lawman MKV

Same specs as Lawman MKIII except redesigned lockwork to reduce double-action trigger pull; faster lock time; redesigned grips; shrouded ejector rod (2" barrel); fixed sights; solid rib. Introduced 1984; dropped 1985.

Perf.: \$325 Exc.: \$250 VGood: \$200

### COLT METROPOLITAN MKIII

Revolver; double action; 38 Spl.; 6-shot swing-out cylinder; 4" barrel; designed for urban law enforcement; fixed sights; choice of service, target grips of checkered walnut; blued finish, standard; nickel, optional. Introduced 1969; dropped 1972.

Perf.: \$350 Exc.: \$300 VGood: \$200

### COLT MODEL 1877 LIGHTNING

Revolver; double action; 32 Colt, 38 Colt; 6-shot cylinder; 4 1/2" - 10" barrels with ejector; 1 1/2", 2 1/2", 3 1/2", 4 1/2", 6" sans ejector; fixed sights; blued or nickel finish; hard rubber grips. Manufactured 1877 to 1909.

Exc.: \$2200 VGood: \$1850 Good: \$1200

### COLT MODEL 1877 THUNDERER

Revolver; double action; 41 Colt; 6-shot cylinder; 4 1/2"-10" barrels with ejector; 1 1/2", 2 1/2", 3 1/2", 4 1/2", 6" sans ejector; fixed sights; blued or nickel finish; hard rubber grips. Manufactured 1877 to 1909.

Exc.: \$2500 VGood: \$1750 Good: \$1350

### COLT MODEL 1878 FRONTIER

Revolver; double action; 32-20, 38-40, 44-40, 45 Colt, 450, 455, 476 Eley; 6-shot cylinder; 4 3/4", 5 1/2", 7 1/2" barrels with ejector; 3 1/2", 4" sans ejector; similar to Lightning model but with heavier frame; lanyard ring in butt; hard rubber grips; fixed sights; blued or nickel finish. Manufactured 1878 to 1905.

Exc.: \$3500 VGood: \$2500 Good: \$1750

# HANDGUNS

## CZ

- Model 27
- Model 38
- Model 50
- Model 52
- Model 75
- Model 75 Compact
- Model 75 Semi-Compact
- Model 83
- Model 85
- Model 85 Combat
- 100 Auto
- Model 1945
- Pocket Duo

## Daewoo

DH40



CZ Model 27

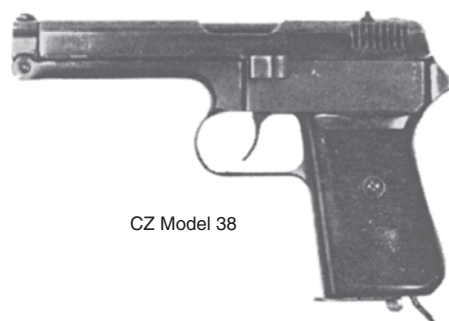

CZ Model 38



CZ Model 83



CZ Model 1945



CZ Pocket Model



CZ Model 75

### CZ MODEL 27

Semi-automatic; 32 ACP; 8-shot magazine; 3 13/16" barrel; 6 1/2" overall length; weighs 25 oz.; vertical retracting grooves on slide; fixed sights; plastic grips; blued finish. Commercial and non-commercial models made until 1939 marked on top rib and left side of frame; post-1941 omit top rib marking; post-war models made until 1951 marked on slide. Manufactured from 1927 to 1951.

Pre-war

Exc.: \$350    VGood: \$250    Good: \$200

Post-1941

Exc.: \$325    VGood: \$275    Good: \$225

Post-war

Exc.: \$300    VGood: \$250    Good: \$200

### CZ MODEL 38

Semi-automatic; double-action-only; 380 ACP; 8-shot magazine; 4 5/8" barrel; 8 1/8" overall length; weighs 32 oz.; plastic grips; fixed sights; blued finish. Also listed as CZ Pistole 39(t) during German occupation. Manufactured 1939 to 1945.

Exc.: \$375    VGood: \$275    Good: \$200

### CZ MODEL 50

Semi-automatic; double action; 32 ACP; 8-shot; 3 3/4" barrel; 6 1/2" overall length; weighs 24 3/4 oz.; frame mounted safety catch; loaded chamber indicator. Issued to Czech police as Model VZ50. Manufactured from 1951 to approximately 1967.

Exc.: \$135    VGood: \$110    Good: \$100

### CZ MODEL 52

Semi-automatic; 7.62 Tokarev; 8-shot; 4 3/4" barrel; 8 1/4" overall length; weighs 40 oz.; complex roller locking breech system. Manufactured from 1952 to approximately 1956.

Exc.: \$150    VGood: \$125    Good: \$100

### CZ MODEL 75

Semi-automatic; double action or double-action-only; 9mm Para., 40 S&W; 15-shot magazine; 4 3/4" barrel; 8" overall length; weighs 35 oz.; all-steel frame; adjustable rear sight, square post front; checkered plastic; black polymer, matte or high-polish blued finish. Imported from the Czech Republic by CZ-USA.

Perf.: \$400    Exc.: \$350    VGood: \$300

### CZ Model 75 Compact

Same specs as Model 75 except 10-shot magazine; 3 15/16" barrel; weighs 32 oz.; removable front sight; non-glare ribbed slide top; squared and serrated trigger-guard; combat hammer. Introduced 1993; imported from the Czech Republic by CZ-USA.

Perf.: \$400    Exc.: \$350    VGood: \$300

### CZ Model 75 Semi-Compact

Same specs as Model 75 Compact with shorter slide and barrel on full-size CZ 75 frame; 10-shot magazine; 9mm Para. only. Introduced 1994; imported from the Czech Republic by CZ-USA.

Perf.: \$400    Exc.: \$350    VGood: \$300

### CZ MODEL 83

Semi-automatic; double action; 32 ACP, 380 ACP; 3 13/16" barrel; 6 15/16" overall length; weighs 261/4 oz.; adjustable rear, removable square post front sight; ambidextrous magazine release and safety; non-glare ribbed slide top; high-impact checkered plastic grips; blue finish.

Perf.: \$300    Exc.: \$250    VGood: \$200

### CZ MODEL 85

Semi-automatic; double action or double-action-only; 9mm Para., 40 S&W; 15-shot magazine; 4 3/4" barrel; 8" overall length; weighs 35 oz.; all-steel frame; ambidextrous slide release and safety levers; non-glare ribbed slide top; squared, serrated trigger-guard; trigger stop to prevent overtravel; adjustable rear sight, square post front; checkered plastic; black polymer, matte or high-polish blued finish. Introduced 1986; imported from the Czech Republic by CZ-USA.

Perf.: \$450    Exc.: \$400    VGood: \$350

### CZ Model 85 Combat

Same specs as the Model 85 except walnut grips; round combat hammer; fully-adjustable rear sight; extended magazine release; trigger parts coated with friction-free beryllium copper. Introduced 1992; imported from the Czech Republic by CZ-USA.

Perf.: \$500    Exc.: \$450    VGood: \$400

### CZ 100 AUTO PISTOL

Caliber: 9mm Para., 40 S&W, 10-shot magazine. Barrel: 3.7". Weight: 24 oz. Length: 6.9" overall. Stocks: Grooved polymer. Sights: Blade front with dot, white outline rear drift adjustable for windage. Features: Double action only with firing pin block; polymer frame, steel slide; has laser sight mount. Introduced 1996. Imported from the Czech Republic by CZ-USA.

Price: 9mm Para. \$389.00

Price: 40 S&W \$399.00

### CZ MODEL 1945

Semi-automatic; double action; 25 ACP; 8-shot magazine; 2" barrel; 5" overall length; plastic grips; fixed sights; blued finish. Manufactured from 1945 to approximately 1960.

Exc.: \$225    VGood: \$175    Good: \$145

### CZ POCKET DUO

Semi-automatic; 25 ACP; 6-shot magazine; 2 1/8" barrel; 4 1/2" overall length; fixed sights; plastic grips; manufactured in Czechoslovakia; blue or nickel finish. Manufactured 1926 to 1960.

Exc.: \$175    VGood: \$150    Good: \$125

### DAEWOO DH40

Semi-automatic; double action; 40 S&W; 10-shot magazine; 4 1/8" barrel; 7 1/2" overall length; weighs 28 1/4 oz.; checkered composition grips; 1/8" blade front sight, adjustable rear; three-dot system; fast-fire mechanism; ambidextrous manual safety with internal firing pin lock; no magazine safety; alloy frame; squared trigger-guard; matte black finish. Imported from Korea by Nationwide Sports Distributors. Introduced 1991; still imported.

New: \$350    Perf.: \$275    Exc.: \$225





Desert Industries  
War Eagle

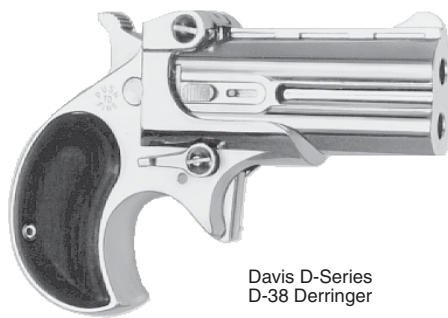

Davis D-Series  
D-38 Derringer



Detonics Combat  
Master Mark V

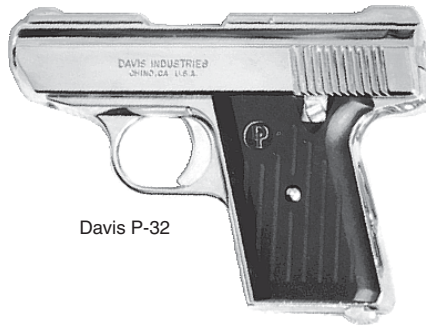

Davis P-32



Desert Industries  
Double Deuce

#### DAKOTA OLD MODEL SINGLE ACTION

Revolvers; single action; 22 LR, 32-20, 357 Mag., 38-40, 44 Spl., 44-40, 45 Colt; 6-shot cylinder; 4 5/8", 5 1/2", 7 1/2" barrel; blade front, fixed rear sight; one-piece walnut stocks; color case-hardened frame; brass grip frame, triggerguard; blued barrel cylinder; also available in nickel finish. Made in Italy. Introduced 1967; sporadic production. Was imported by EMF.

Perf.: \$275 Exc.: \$225 VGood: \$200

Nickel finish

Perf.: \$325 Exc.: \$275 VGood: \$225

#### DAKOTA SHERIFF'S MODEL

Revolvers; single action; 32-20, 357 Mag., 38-40, 44 Spl., 44-40, 45 Colt; 6-shot; 3 1/2" barrel; blade front, fixed rear sight; one-piece walnut stock; blued finish. Made in Italy. Introduced 1994; was imported by EMF.

Perf.: \$350 Exc.: \$300 VGood: \$250

#### DAVIS BIG-BORE DERRINGERS

Derringer; over/under; 22 WMR, 32 H&R Mag., 38 Spl., 9mm Para.; 2-shot; 2 3/4" barrels; 4 9/16" overall length; weighs about 14 oz.; textured black synthetic grips; fixed sights; chrome or black teflon finish. Larger than the Davis D-Series models. Made in U.S. by Davis Industries. Introduced 1995; still produced.

Perf.: \$60 Exc.: \$45 VGood: \$35

#### DAVIS D-SERIES DERRINGERS

Derringer over/under; 22 WMR, 32 H&R, 38 Spl.; 2-shot; 2 3/8" barrels; 4" overall length; weighs about 11 1/2 oz.; textured black synthetic grips; blade front, fixed notch rear sight; alloy frame; steel-lined barrels; steel breechblock; plunger-type safety with integral hammer block; chrome or black Teflon finish. Made in U.S. by Davis Industries. Introduced 1992; still produced.

Perf.: \$60 Exc.: \$45 VGood: \$35

#### DAVIS LONG-BORE DERRINGERS

Derringer over/under; 22 WMR, 32 H&R Mag., 38 Spl., 9mm Para.; 2-shot; 3 1/2" barrels; 5 3/8" overall length; weighs 16 oz.; textured black synthetic grips; fixed sights; chrome or black teflon finish. Larger than the Davis D-Series models. Made in U.S. by Davis Industries. Introduced 1995; still produced.

Perf.: \$75 Exc.: \$60 VGood: \$50

#### DAVIS P-32

Semi-automatic; double action; 32 ACP; 6-shot magazine; 2 13/16" barrel; 5 3/8" overall length; weighs 22 oz.; laminated wood stocks; fixed sights; chrome or black Teflon finish. Introduced 1986; still in production.

Perf.: \$70 Exc.: \$60 VGood: \$50

#### DAVIS P-380

Semi-automatic; double action; 380 ACP; 5-shot magazine; 2 13/16" barrel; 5 7/16" overall length; weighs 22 oz.; fixed sights; black composition grips; chrome or black Teflon finish. Introduced 1991; still in production.

Perf.: \$80 Exc.: \$60 VGood: \$50

#### DESERT INDUSTRIES DOUBLE DEUCE

Semi-automatic; double action; 22 LR; 6-shot; 2 1/2" barrel; 5 1/2" overall length; weighs 15 oz.; fixed groove sights; smooth rosewood grips; ambidextrous slide-mounted safety; stainless steel construction; matte finish. Introduced 1991; still in production by Steel City Arms.

Perf.: \$325 Exc.: \$275 VGood: \$225

#### DESERT INDUSTRIES TWO-BIT SPECIAL

Semi-automatic; double action; 25 ACP; 5-shot; 2 1/2" barrel; 5 1/2" overall length; weighs 15 oz.; fixed groove sights; smooth rosewood grips; ambidextrous slide-mounted safety; stainless steel construction; matte finish. Introduced 1991; still in production.

Perf.: \$325 Exc.: \$275 VGood: \$225

## HANDGUNS

### Dakota

Old Model Single Action  
Sheriff's Model

### Davis

Big-Bore Derringers  
D-Series Derringers  
Long-Bore Derringers  
P-32  
P-380

### Desert Eagle

(See Magnum Research  
Desert Eagle)

### Desert Industries

Double Deuce  
Two-Bit Special  
War Eagle

### Detonics

Combat Master Mark I  
Combat Master Mark V  
Combat Master Mark VI  
Combat Master Mark VII  
Compmaster

#### DESERT INDUSTRIES WAR EAGLE

Semi-automatic; double action; 380 ACP, 9mm Para., 40 S&W, 10mm Auto, 45 ACP; 10-shot, 14-shot (9mm), 8-shot (380 ACP); 4" barrel; fixed sights; rosewood grips; stainless steel construction; matte finish. Introduced 1991; still in production.

Perf.: \$700 Exc.: \$650 VGood: \$550

#### DETONICS COMBAT MASTER MARK I

Semi-automatic; 9mm Para., 38 Super, 45 ACP; 6-shot magazine (45 ACP); 3 1/2" barrel; 6 3/4" overall length; weighs 28 oz.; fixed or adjustable combat-type sights; checkered walnut stocks; throated barrel; polished feed ramp; self-adjusting cone barrel centering system; beveled magazine inlet; full-clip indicator; two-tone matte blue and stainless finish. Introduced 1977; discontinued 1992.

Perf.: \$700 Exc.: \$600 VGood: \$500

#### Detonics Combat Master Mark V

Same specs as Combat Master I except all matte stainless finish. Introduced 1977; discontinued 1985.

Perf.: \$650 Exc.: \$550 VGood: \$500

#### Detonics Combat Master Mark VI

Same specs as Combat Master Mark I except 451 Detonics Mag.; adjustable sights; polished stainless steel slide. Introduced 1977; discontinued 1989.

Perf.: \$950 Exc.: \$750 VGood: \$600

#### Detonics Combat Master Mark VII

Same specs as Combat Master Mark VI except no sights as special order option. Introduced 1977; discontinued 1982.

Perf.: \$850 Exc.: \$750 VGood: \$650

#### DETONICS COMPMASER

Semi-automatic; 45 ACP; 7-, 8-shot magazine; 5", 6" barrel; Millet adjustable sights; checkered Pachmayr stocks; matching mainspring housing; Detonics recoil system; extended grip safety; ambidextrous safety; extended magazine release; stainless steel. Introduced 1988; discontinued 1992.

Perf.: \$1800 Exc.: \$1400 VGood: \$1200

# HANDGUNS

## E.A.A.

Witness Silver Team

## EMF

1894 Target Bisley  
Dakota 1875 Outlaw  
Dakota 1890 Police  
Dakota New Model  
Hartford  
Hartford Pinkerton Model

## Entrèprise

Elite P500  
Tactical P500  
Medalist P500  
Boxer P500  
Tournament Shooter Model I



EMF Hartford



Entrèprise Boxer P500



Entrèprise Elite P500



Entrèprise Tactical P500

### E.A.A. WITNESS SILVER TEAM

Semi-automatic; single action; 9mm Para., 9x21, 38 Super, 10mm, 40 S&W, 45 ACP; 10-shot magazine; 5 1/8" barrel; 9 5/8" overall length; weighs 41 1/2 oz.; black rubber grips; square post front sight, fully-adjustable rear; double-chamber compensator; competition SA trigger; extended safety; oval magazine release; competition hammer; beveled magazine well; beavertail grip; hand-fitted major components; match-grade barrel; double-dip blue finish. Comes with Super Sight and drilled and tapped for scope mount. Built for the intermediate competition shooter. From E.A.A. Custom Shop. Marketed by European American Armory Corp. Introduced 1992; still offered.

Perf.: \$850 Exc.: \$750 VGood: \$650

### EMF 1894 TARGET BISLEY

Revolver; single action; 45 Colt; 5 1/2", 7 1/2" barrel; 11" overall length (5 1/2" barrel); weighs about 45 oz.; blade front, fixed rear sight; smooth walnut grips, specially shaped grips frame and triggerguard; wide spur hammer; blue or nickel finish. Imported by E.M.F. Introduced 1995; still imported.

Blue finish

New: \$600 Perf.: \$525 Exc.: \$475

Nickel finish

New: \$675 Perf.: \$600 Exc.: \$550

### EMF DAKOTA 1875 OUTLAW

Revolver; single action; 357, 44-40, 45 Colt; 7 1/2" barrel; 13 1/2" overall length; weighs 46 oz.; smooth walnut grips; blade front, fixed groove rear sight; authentic copy of 1875 Remington with firing pin in hammer; color case-hardened frame, blue cylinder, barrel; steel backstrap and brass triggerguard. Also offered in nickel finish, factory engraved. Imported by E.M.F.; still imported.

New: \$400 Perf.: \$350 Exc.: \$300

Nickel finish

New: \$450 Perf.: \$400 Exc.: \$375

Engraved

New: \$500 Perf.: \$450 Exc.: \$400

Engraved nickel

New: \$700 Perf.: \$650 Exc.: \$600

### EMF DAKOTA 1890 POLICE

Revolver; single action; 357, 44-40, 45 Colt; 5 1/2" barrel; 12 1/2" overall length; weighs 40 oz.; smooth walnut grips; blade front, fixed groove rear sight; authentic copy of 1875 Remington with firing pin in hammer; color case-hardened frame, blue cylinder, barrel; steel backstrap and brass triggerguard; lanyard ring in butt. Also offered in nickel finish, factory engraved. Imported by E.M.F.; still imported.

Perf.: \$400 Exc.: \$350 VGood: \$300

Nickel finish

Perf.: \$550 Exc.: \$500 VGood: \$375

Engraved

Perf.: \$600 Exc.: \$550 VGood: \$500

Engraved nickel

Perf.: \$800 Exc.: \$750 VGood: \$600

### EMF DAKOTA NEW MODEL

Revolver; single action; 357 Mag., 44-40, 45 Colt; 6-shot cylinder; 3 1/2", 4 3/4", 5 1/2", 7 1/2" barrel; 13" overall length (7 1/2" barrel); weighs 45 oz.; blade front, fixed rear sight; smooth walnut grips; color case-hardened frame, black nickel backstrap and triggerguard; also offered nickel plated. Imported by E.M.F.; still imported.

Perf.: \$350 Exc.: \$300 VGood: \$250

Nickel-plated

Perf.: \$450 Exc.: \$375 VGood: \$300

### EMF HARTFORD

Revolver; single action; 22 LR, 357 Mag., 32-20, 38-40, 44-40, 44 Spec., 45 Colt; 6-shot cylinder; 4 3/4", 5 1/2", 7 1/2" barrel; 13" overall length (7 1/2" barrel); weighs 45 oz.; smooth walnut grips; blade front, fixed rear sight; identical to the original Colts with inspector cartouche on left grip, original patent dates and U.S. markings; all major parts serial numbered using original Colt-style lettering, numbering; bullseye ejector head and color case-hardening on frame and hammer. Imported by E.M.F. Introduced 1990; still imported.

Perf.: \$450 Exc.: \$375 VGood: \$300

Cavalry or Artillery model

Perf.: \$450 Exc.: \$375 VGood: \$300

Nickel-plated

Perf.: \$550 Exc.: \$475 VGood: \$400

Engraved, nickel-plated

Perf.: \$700 Exc.: \$650 VGood: \$550

### EMF HARTFORD PINKERTON MODEL

Revolver; single action; 45 Colt; 6-shot cylinder; 4" barrel; 10" overall length; weighs 40 oz.; smooth walnut grips; blade front, fixed rear sight; bird's-head grip; identical to the original Colts with original patent dates and markings; all major parts serial numbered using original Colt-style lettering, numbering; bullseye ejector head and color case-hardening on frame and hammer. Imported by E.M.F. Introduced 1990; still imported.

Perf.: \$400 Exc.: \$350 VGood: \$300

### ENTRÈPRISE ELITE P500

Semi-automatic; 45 ACP, 10-shot magazine. Barrel: 5". Weight: 40 oz. Length: 8.5" overall. Stocks: Black ultra-slim, double diamond, checkered synthetic. Sights: Dovetailed blade front, rear adjustable for windage; three-dot system. Features: Reinforced dust cover; lowered and flared ejection port; squared trigger guard; adjustable match trigger; bolstered front strap; high grip cut; high ride beavertail grip safety; steel flat mainspring housing; extended thumb lock;

skeletonized hammer, match grade sear, disconnecter; Wolff springs. Introduced 1998. Made in U.S. by Entrèprise Arms.

Perf.: \$600 Exc.: \$550 VGood: \$475

### Entrèprise Tactical P500

Similar to the Elite model except has Tactical2 Ghost Ring sight or Novak lo-mount sight; ambidextrous thumb safety; front and rear slide serrations; full-length guide rod; throated barrel, polished ramp; tuned match extractor; fitted barrel and bushing; stainless firing pin; slide lapped to frame; dehorned. Introduced 1998. Made in U.S. by Entrèprise Arms.

Perf.: \$750 Exc.: \$650 VGood: \$575

### Entrèprise Medalist P500

Similar to the Elite model except has adjustable Competizione "melded" rear sight with dovetailed Patridge front; machined slide parallel rails with polished breech face and barrel channel; front and rear slide serrations; lowered and flared ejection port; full-length one-piece guide rod with plug; National Match barrel and bushing; stainless firing pin; tuned match extractor; oversize firing pin stop; throated barrel and polished ramp; slide lapped to frame. Introduced 1998. Made in U.S. by Entrèprise Arms.

Perf.: \$800 Exc.: \$650 VGood: \$575

### Entrèprise Boxer P500

Similar to the Medalist model except has adjustable Competizione "melded" rear sight with dovetailed Patridge front; high mass chiseled slide with sweep cut; machined slide parallel rails; polished breech face and barrel channel. Introduced 1998. Made in U.S. by Entrèprise Arms.

Perf.: \$850 Exc.: \$750 VGood: \$650

### ENTRÈPRISE TOURNAMENT SHOOTER MODEL I

Semi-automatic; 45 ACP, 10-shot magazine. Barrel: 5". Weight: 40 oz. Length: 8.5" overall. Stocks: Black ultra-slim double diamond checkered synthetic. Sights: Dovetailed Patridge front, adjustable Competizione "melded" rear. Features: Oversized magazine release button; flared magazine well; fully machined parallel slide rails; polished barrel channel and breech face; front and rear slide serrations; serrated top of slide; stainless ramped bull barrel with fully supported chamber; full-length guide rod with plug; stainless firing pin; match extractor; polished ramp; tuned match extractor; hard chrome finish. Introduced 1998. Made in U.S. by Entrèprise Arms.

Perf.: \$1850 Exc.: \$1600 VGood: \$1450



# HANDGUNS

## FEG

B9R  
FP9  
GKK-40C  
GKK-45C  
GKK-92C  
Mark II AP  
Mark II AP22  
MBK-9HP  
MBK-9HPC  
P9R  
PJK-9HP  
PMK-380  
SMC-22



FEG B9R



FEG FP9



FEG PJK-9HP



FEG GKK-45C



FEG P9R

### FEG B9R

Semi-automatic; 380 ACP; 10-shot magazine; 4" barrel; 7" overall length; weighs 25 oz.; blade front, drift-adjustable rear sight; hand-checked walnut grips; hammer drop safety; grooved backstrap; squared trigger guard. Introduced 1993; still imported.

**New:** \$290 **Perf.:** \$250 **Exc.:** \$200

### FEG FP9

Semi-automatic; single action; 9mm Para.; 10-shot magazine; 5" barrel; 7 7/8" overall length; weighs 35 oz.; checkered walnut grips; blade front sight, windage-adjustable rear; full-length ventilated rib; polished blue finish; comes with extra magazine. Imported from Hungary by Century International Arms. Introduced 1993; still imported.

**New:** \$225 **Perf.:** \$200 **Exc.:** \$175

### FEG GKK-40C

Semi-automatic; double action; 40 S&W; 9-shot magazine; 4 1/8" barrel; 7 3/4" overall length; weighs 36 oz.; hand-checked walnut grips; blade front sight, windage-adjustable rear; three-dot system; combat-type trigger guard; polished blue finish; comes with two magazines, cleaning rod. Imported from Hungary by K.B.I., Inc. Introduced 1995; no longer imported.

**New:** \$300 **Perf.:** \$250 **Exc.:** \$200

### FEG GKK-45C

Semi-automatic; double action; 45 ACP; 8-shot magazine; 4 1/8" barrel; 7 3/4" overall length; weighs 36 oz.; hand-checked walnut grips; blade front sight, windage-adjustable rear; three-dot system; combat-type

trigger guard; polished blue finish; comes with two magazines, cleaning rod. Imported from Hungary by K.B.I., Inc. Introduced 1995; no longer imported.

**New:** \$300 **Perf.:** \$250 **Exc.:** \$200

### FEG GKK-92C

Semi-automatic; double action; 9mm Para.; 14-shot magazine; 4" barrel; 7 3/8" overall length; weighs 34 oz.; hand-checked walnut grips; blade front sight, windage-adjustable rear; slide-mounted safety; hooked trigger guard; finger-grooved frontstrap; polished blue finish. Imported from Hungary by K.B.I., Inc. Introduced 1992; no longer imported.

**Perf.:** \$300 **Exc.:** \$250 **VGood:** \$200

### FEG MARK II AP PISTOL

Semi-automatic; double action; 380 ACP, 7-shot magazine. Barrel: 3.9". Weight: 27 oz. Length: 6.9" overall. Stocks: Checkered black composition. Sights: Blade front, rear adjustable for windage. Features: Double action. All-steel construction. Polished blue finish. Comes with two magazines. Introduced 1997. Imported from Hungary by Interarms.

**Perf.:** \$225 **Exc.:** \$200 **VGood:** \$175

### FEG MARK II AP22 PISTOL

Semi-automatic; double action; 22 LR, 8-shot magazine. Barrel: 3.4". Weight: 23 oz. Length: 6.3" overall. Stocks: Checkered black composition. Sights: Blade front, rear adjustable for windage. Features: Double action. All-steel construction. Polished blue finish. Introduced 1997. Imported from Hungary by Interarms.

**Perf.:** \$275 **Exc.:** \$250 **VGood:** \$225

### FEG MBK-9HP

Semi-automatic; double action; 9mm Para.; 14-shot magazine; 4 5/8" barrel; 7 3/8" overall length; weighs 34 oz.; hand-checked walnut grips; blade front sight, windage-adjustable rear; slide-mounted safety; hooked trigger guard; smooth frontstrap; polished blue finish. Imported from Hungary by K.B.I., Inc. Introduced 1992; no longer imported.

**Perf.:** \$275 **Exc.:** \$250 **VGood:** \$225

### FEG MBK-9HPC

Semi-automatic; double action; 9mm Para.; 14-shot magazine; 4" barrel; 7 1/4" overall length; weighs 34 oz.; hand-checked walnut grips; blade front sight, windage-adjustable rear; slide-mounted safety; hooked trigger guard; smooth frontstrap; polished blue finish. Imported from Hungary by K.B.I., Inc. Introduced 1992; no longer imported.

**Perf.:** \$275 **Exc.:** \$250 **VGood:** \$225

### FEG P9R

Semi-automatic; double action; 9mm Para.; 10-shot magazine; 4 5/8" barrel; 7 15/16" overall length; weighs 35 oz.; checkered walnut grips; blade front sight, windage-adjustable rear; slide-mounted safety; all-steel construction with polished blue finish; comes with extra magazine. Imported from Hungary by Century International Arms. Introduced 1993; still imported.

**New:** \$225 **Perf.:** \$200 **Exc.:** \$185

### FEG PJK-9HP

Semi-automatic; single action; 9mm Para.; 10-shot magazine; 4 3/4" barrel; 8" overall length; weighs 32 oz.; hand-checked walnut grips; blade front sight, windage-adjustable rear; three-dot system; polished blue or hard chrome finish; rounded combat-style serrated hammer; comes with two magazines and cleaning rod. Imported from Hungary by K.B.I., Inc. Introduced 1992; still imported.

**New:** \$225 **Perf.:** \$200 **Exc.:** \$175

### FEG PMK-380

Semi-automatic; double action; 380 ACP; 7-shot magazine; 4" barrel; 7" overall length; weighs 21 oz.; checkered black nylon thumbrest grips; blade front sight, windage-adjustable rear; anodized aluminum frame; polished blue slide; comes with two magazines, cleaning rod. Imported from Hungary by K.B.I., Inc. Introduced 1992; no longer imported.

**Perf.:** \$200 **Exc.:** \$175 **VGood:** \$150

### FEG SMC-22

Semi-automatic; double action; 22 LR; 8-shot magazine; 3 1/2" barrel; 6 1/8" overall length; weighs 18 1/2 oz.; checkered composition thumbrest grips; blade front sight, windage-adjustable rear; alloy frame, steel slide; blue finish; comes with two magazines, cleaning rod. Patterned after the PPK pistol. Imported from Hungary by K.B.I., Inc. Introduced 1994; still imported.

**New:** \$200 **Perf.:** \$175 **Exc.:** \$150

# HANDGUNS

## Freedom Arms

- Boot Gun
- FA-S-22LR
- FA-S-22M
- Mini Revolver
- Model 252 Silhouette
- Model 97 Mid Frame
- Model 252 Varmint
- Model 353
- Model 353 Silhouette
- Model 555

## Frommer

- Baby Pocket Model
- Liliput Pocket Model
- Stop Pocket Model

## FTL

- Auto Nine
- Pocket Partner

## Gal

- Compact Auto Pistol

## Galesi

- Model 6
- Model 9



Frommer Liliput Pocket Model



Galesi Model 9



FTL Auto Nine

### FREEDOM ARMS BOOT GUN

Revolver; single action; 22 LR, 22 WMR; 3" barrel; 5 7/8" overall length; weighs 5 oz.; oversize grips; floating firing pin; stainless steel construction. Introduced 1982; dropped 1990.

Perf.: \$225 Exc.: \$200 VGood: \$175

22 WMR

Perf.: \$250 Exc.: \$200 VGood: \$175

### FREEDOM ARMS FA-S-22LR

Revolver; 22 LR; 5-shot; 1", 1 3/4", 3" barrels; blade front, notched rear sights; black ebonite grips; stainless steel construction; partial high polish finish; simulated ivory or ebony grips.

Perf.: \$225 Exc.: \$200 VGood: \$165

### FREEDOM ARMS FA-S-22M

Revolver; 22 WMR; 4-shot; 1", 1 3/4", 3" barrels; stainless steel construction; blade front, notched rear sights; simulated ivory or ebony grips.

Perf.: \$75 Exc.: \$225 VGood: \$200

### FREEDOM ARMS MINI REVOLVER

Revolver; single action; 22 LR, 22 WMR; 5-shot; 4" (22 WMR), 1", 1 3/4" barrel (22 LR); 4" overall length; blade front sight, notched rear; black ebonite grips; stainless steel construction; marketed in presentation case. Introduced 1978; dropped 1990.

Perf.: \$200 Exc.: \$175 VGood: \$165

### FREEDOM ARMS MODEL 252 SILHOUETTE

Revolver; single action; 22 LR; 5-shot cylinder, 10" barrel; weighs 63 oz.; Pradrig-type front sight, click-adjustable rear; Western-style black Micarta grips; constructed of stainless steel on 454 Casull frame; lightened hammer; two-point firing pin; extra 22 WMR cylinder available. Introduced 1991; still in production.

LMSR: \$1432

Perf.: \$1000 Exc.: \$850 VGood: \$750

With extra WMR cylinder

Perf.: \$1200 Exc.: \$1000 VGood: \$900

### FREEDOM ARMS MODEL 97 MID FRAME REVOLVER

Caliber: 357 Mag., 6-shot cylinder. Barrel: 5-1/2", 7-1/2". Weight: 40 oz. (5-1/2" barrel). Length: 10-3/4" overall (5-1/2" barrel). Stocks: Wine wood. Sights: Blade on ramp front, fixed or fully adjustable rear. Features: Made of stainless steel; polished cylinder, matte frame. Introduced 1997.

New: \$1250 Perf.: \$1000 Exc.: \$850

### Freedom Arms Model 252 Varmint

Same specs as Model 252 Silhouette except 7 1/2" barrel; weighs 59 oz.; black/green laminated hardwood grips; brass bead front sight, fully-adjustable rear; extra 22 WMR cylinder available. Introduced 1991; still produced.

Perf.: \$1000 Exc.: \$800 VGood: \$700

### FREEDOM ARMS MODEL 353

Revolver; single action; 5-shot; 4 3/4", 6", 7 1/2", 9" barrel; 14" overall length (7 1/2" barrel); weighs about 59 oz.; blade front sight on ramp, fully-adjustable rear; Pachmayr rubber grips (Field Grade), impregnated hardwood grips (Premier Grade); Field Grade with matte stainless finish; Premier Grade with brush stainless finish. Introduced 1992; still in production.

Field Grade

New: \$1000 Perf.: \$900 Exc.: \$700

Premier Grade

New: \$1300 Perf.: \$1000 Exc.: \$800

### Freedom Arms Model 353 Silhouette

Same specs as Model 353 except 9" barrel; silhouette competition sights; Field Grade finish and grips; trigger over-travel screw; front sight hood. Introduced 1992; still in production.

New: \$1100 Perf.: \$1000 Exc.: \$850

### FREEDOM ARMS MODEL 555

Revolver; single action; 50 AE; 5-shot cylinder; 4 3/4", 6", 7 1/2", 10" barrel; 14" overall length (7 1/2" barrel); weighs 50 oz.; removable blade front sight on ramp, adjustable rear; Pachmayr rubber grips on Field Grade; impregnated hardwood on Premier Grade; Field Grade with matte stainless finish; Premier Grade with brushed stainless finish. Introduced 1994; still produced.

Field Grade

New: \$1100 Perf.: \$1000 Exc.: \$850

Premier Grade

New: \$1300 Perf.: \$1250 Exc.: \$1000

### FROMMER BABY POCKET MODEL

Semi-automatic; 32 ACP; 6-shot magazine; smaller version of Stop Pocket Model with 2" barrel; 4 3/4" overall length. Manufactured from 1919 to approximately 1922.

Exc.: \$350 VGood: \$275 Good: \$200

### FROMMER LILIPUT POCKET MODEL

Semi-automatic; blowback action; 25 ACP; 6-shot magazine; 2 1/8" barrel; 4 5/16" overall length; hard rubber stocks; fixed sights; blued finish. Manufactured 1921 to 1924.

Exc.: \$250 VGood: \$200 Good: \$150

### FROMMER STOP POCKET MODEL

Semi-automatic; 32 ACP, 380 ACP; 6-shot (380 ACP), 7-shot (32 ACP) magazine; 3 7/8" barrel; 6 1/2" overall length; external hammer; grooved wood or checkered hard rubber stocks; fixed sights; blued finish. Manufactured in Hungary, 1912 to 1920.

Exc.: \$325 VGood: \$250 Good: \$175

### FTL AUTO NINE

Semi-automatic; single action; 22 LR; 8-shot magazine; 2 1/8" barrel; 4 5/16" overall length; weighs 9 1/4 oz.; blade front sight, fixed notch rear; checkered black plastic grips; manual push-button safety; alloy frame; hard chromed slide and magazine; barrel support bushing. Made by Auto Nine Corp. Marketed by FTL Marketing Corp. Introduced 1985; no longer in production.

Perf.: \$175 Exc.: \$150 VGood: \$125

### FTL POCKET PARTNER

Semi-automatic; 22 LR; 8-shot magazine; 2 1/4" barrel; 4 3/4" overall length; weighs 10 oz.; internal hammer; fixed sights; checkered plastic stocks; all-steel construction; brushed blue finish. Introduced 1985; no longer in production.

Perf.: \$125 Exc.: \$100 VGood: \$85

### GAL COMPACT AUTO PISTOL

Caliber: 45 ACP, 8-shot magazine. Barrel: 4.25". Weight: 36 oz. Length: 7.75" overall. Stocks: Rubberized wrap-around. Sights: Low profile, fixed, three-dot system. Features: Forged steel frame and slide; competition trigger, hammer, slide stop magazine release, beavertail grip safety; front and rear slide grooves; two-tone finish. Introduced 1996. Imported from Israel by J.O. Arms, Inc.

Perf.: \$425 Exc.: \$375 VGood: \$300

### GALESI MODEL 6

Semi-automatic; 25 ACP; 6-shot magazine; 2 1/2" barrel; 4 3/8" overall length; plastic stocks; slide-top groove sights; blued finish. Manufactured in Italy. Introduced 1930; no longer in production.

Exc.: \$250 VGood: \$150 Good: \$125

### GALESI MODEL 9

Semi-automatic; 22 LR, 32 ACP, 380 ACP; 7-shot magazine; 3 1/4" barrel; plastic stocks; fixed sights; blued finish. Introduced 1930; no longer in production.

Exc.: \$300 VGood: \$250 Good: \$175





Glock Model 24  
Competition



Grendel P-10



Great Western Frontier



Glock 26



Glock 27



Glock 29

#### GLOCK MODEL 24 COMPETITION

Semi-automatic; double action; 40 S&W; 10-shot magazine; 6" barrel; 8 1/2" overall length; weighs 29 1/2 oz.; black polymer grips; blade front sight with dot, white outline windage-adjustable rear; long-slide competition model available as compensated or non-compensated; factory-installed competition trigger; drop-free magazine. Imported from Austria by Glock, Inc. Introduced 1994; still imported.

**New:** \$650 **Perf.:** \$525 **Exc.:** \$450

Compensated barrel

**New:** \$700 **Perf.:** \$575 **Exc.:** \$500

#### GLOCK 26, 27

Semi-automatic; 9mm Para. (M26), 10-shot magazine; 40 S&W (M27), 9-shot magazine. Barrel: 3.47". Weight: 21.75 oz. Length: 6.3" overall. Stocks: Integral. Stippled polymer. Sights: Dot on front blade, fixed or fully adjustable white outline rear. Features: Sub-compact size. Polymer frame, steel slide; double-action trigger with "Safe Action" system, three safeties. Matte black Tenifer finish. Hammer-forged barrel. Imported from Austria by Glock, Inc. Introduced 1996.

**Perf.:** \$500 **Exc.:** \$450 **VGood:** \$400

Adjustable sight

**Perf.:** \$525 **Exc.:** \$475 **VGood:** \$425

#### GLOCK 29, 30

Caliber: 10mm (M29), 45 ACP (M30), 10-shot magazine. Barrel: 3.78". Weight: 24 oz. Length: 6.7" overall. Stocks: Integral. Stippled polymer. Sights: Dot on front, fixed or fully adjustable white outline rear. Features: Compact size. Polymer frame steel slide; double-recoil spring reduces recoil; Safe Action system with three safeties; Tenifer finish. Two magazines supplied. Introduced 1997. Imported from Austria by Glock, Inc.

**Perf.:** \$550 **Exc.:** \$475 **VGood:** \$425

Adjustable sight

**Perf.:** \$575 **Exc.:** \$500 **VGood:** \$450

#### GOLAN

Semi-automatic; 9mm Para., 40 S&W, 10-shot magazine. Barrel: 3.9". Weight: 34 oz. Length: 7" overall. Stocks: Textured composition. Sights: Fixed. Features: Fully ambidextrous double/single action; forged steel slide, alloy frame; matte blue finish. Introduced 1994. Imported from Israel by J.O. Arms, Inc.

**Perf.:** \$550 **Exc.:** \$450 **VGood:** \$400

## HANDGUNS

### Glock

Model 24 Competition  
Glock 26, 27  
Glock 29, 30

### Golan

### Great Western

Derringer  
Frontier

### Grendel

P-10  
P-12  
P-30  
P-30L  
P-30M  
P-31

### Guardian

Guardian-SS

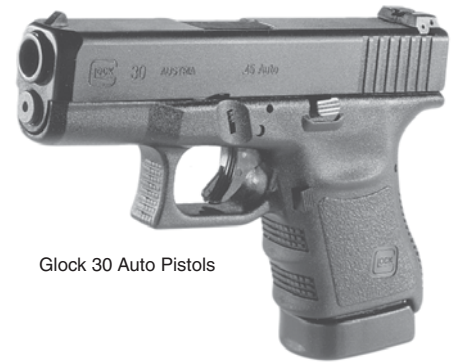

Glock 30 Auto Pistols

#### GREAT WESTERN DERRINGER

Derringer; over/under; 38 S&W; 2-shot; 3" barrels; 5" overall length; checkered black plastic grips; fixed sights; blued finish. Replica of Remington Double Derringer. Manufactured 1953 to 1962.

**Exc.:** \$275 **VGood:** \$200 **Good:** \$150

#### GREAT WESTERN FRONTIER

Revolver; single action; 22 LR, 22 Hornet, 38 Spl., 357 Mag., 44 Spl., 44 Mag., 45 Colt; 6-shot cylinder; 4 3/4", 5 1/2", 7 1/2" barrel lengths; grooved rear sight, fixed blade front; imitation stag grips; blued finish. Was sold primarily by mail order. Manufactured 1951 to 1962.

**Exc.:** \$350 **VGood:** \$300 **Good:** \$250

#### GRENDEL P-10

Semi-automatic; double action; 380 ACP; 10-shot magazine; 3" barrel; 5 5/16" overall length; weighs 15 oz.; checkered polycarbonate metal composite grips; fixed sights; inertia safety hammer system; magazine loads from top; matte black, electroless nickel or green finish. Made in U.S. by Grendel, Inc. Introduced 1987; discontinued 1991.

**Perf.:** \$110 **Exc.:** \$90 **VGood:** \$75

#### GRENDEL P-12

Semi-automatic; double action; 380 ACP; 10-shot magazine; 3" barrel; 5 5/16" overall length; weighs 13 oz.; checkered DuPont ST-800 polymer grips; fixed sights; inertia safety hammer system; all-steel frame; grip forms magazine well and trigger guard; blue finish. Made in U.S. by Grendel, Inc. Introduced 1992; still produced.

**New:** \$150 **Perf.:** \$125 **Exc.:** \$110

Electroless nickel finish

**New:** \$170 **Perf.:** \$150 **Exc.:** \$135

#### GRENDEL P-30

Semi-automatic; double action; 22 WMR; 30-shot magazine; 5", 8" barrel; 8 1/2" overall length (5" barrel); weighs 21 oz. (5" barrel); checkered Zytel grips;

blade front sight, fixed rear; blowback action with fluted chamber; ambidextrous safety; reversible magazine catch. Made in U.S. by Grendel, Inc. Introduced 1990; dropped 1994.

**Perf.:** \$175 **Exc.:** \$150 **VGood:** \$135

#### Grendel P-30L

Same specs as the P-30 except 8" barrel only. Made in U.S. by Grendel, Inc. Introduced 1990; dropped 1994.

**Perf.:** \$200 **Exc.:** \$175 **VGood:** \$165

#### Grendel P-30M

Same specs as the P-30 except removable muzzlebrake. Made in U.S. by Grendel, Inc. Introduced 1990; dropped 1994.

**Perf.:** \$200 **Exc.:** \$175 **VGood:** \$150

#### GRENDEL P-31

Semi-automatic; 22 WMR; 30-shot magazine; 11" barrel; 17 1/2" overall length; 48 oz.; adjustable blade front, fixed rear; blowback action with fluted chamber; ambidextrous safety; muzzlebrake; scope mount optional; checkered black Zytel grip and forend; matte black finish. Made in U.S. by Grendel, Inc. Introduced 1991; dropped 1995.

**Perf.:** \$300 **Exc.:** \$250 **VGood:** \$225

#### GUARDIAN-SS

Semi-automatic; double action; 380 ACP; 6-shot magazine; 3 1/4" barrel; 6" overall length; weighs 20 oz.; checkered walnut stocks; ramp front sight, windage-adjustable combat rear; narrow polished trigger; Pachmayr grips; blue slide; hand-fitted barrel; polished feed ramp; funneled magazine well; stainless steel. Introduced 1982; dropped 1985. Marketed by Michigan Armament, Inc.

**Exc.:** \$300 **VGood:** \$250 **Good:** \$200

# HANDGUNS

## Hawes

Medallion Model  
Trophy Model

## Hawes/SIG-Sauer

P220

## Heckler & Koch

HK4

Mark 23

P7 K3

P7 M8

P7 M10

P7 M13

P7 PSP

P9S

P9S Competition Kit

P9S Target

SP 89



H&K HK4



H&K P9S



H&K P7 M8



H&K P7 M13



H&K Mark 23

### HAWES MEDALLION MODEL

Revolver; double action; 22 LR, 38 Spl.; 6-shot; 3", 4", 6" barrel; fixed sights; swing-out cylinder; blued finish. No longer in production.

Exc.: \$135 VGood: \$125 Good: \$100

### HAWES TROPHY MODEL

Revolver; double action; 22 LR, 38 Spl.; 6-shot; 6" barrel; adjustable sights; swing-out cylinder; blued finish. No longer in production.

Exc.: \$135 VGood: \$125 Good: \$100

### HAWES/SIG-SAUER P220

Semi-automatic; 9mm Para., 38 Super, 45 ACP; 7-shot magazine (45 ACP), 9-shot (9mm, 38); 4 3/8" barrel; 7 3/4" overall length; checkered European walnut or black plastic stocks; windage-adjustable rear sight, blade front; square combat triggerguard. Manufactured in Germany. Introduced 1977; still in production; dropped by Hawes in 1980. Also known as Browning BDA, SIG/Sauer P220.

Exc.: \$450 VGood: \$400 Good: \$350

### HECKLER & KOCH HK4

Semi-automatic; double action; 22 LR, 25 ACP, 32 ACP, 380 ACP; 8-shot magazine; 3 1/2" barrel; 6" overall length; windage-adjustable rear sight, fixed front; checkered black plastic grips; blued finish. Early version available with interchangeable barrels, magazines for four calibers. Imported from Germany originally by Harrington & Richardson, then by Heckler & Koch; importation dropped 1984.

Exc.: \$350 VGood: \$275 Good: \$200

Four caliber set

Exc.: \$750 VGood: \$650 Good: \$500

### HECKLER & KOCH MARK 23

Semi-automatic; 45 ACP, 10-shot magazine. Barrel: 5.87". Weight: 43 oz. Length: 9.65" overall. Stocks: Integral with frame; black polymer. Sights: Blade front, rear drift adjustable for windage; three-dot. Features: Polymer frame; double action; exposed hammer; short recoil, modified Browning action. Civilian version of the SOCOM pistol. Introduced 1996. Imported from Germany by Heckler & Koch, Inc.

Exc.: \$1850 VGood: \$1500 Good: \$1200

### HECKLER & KOCH P7 K3

Semi-automatic; single action; 22 LR, 380 ACP; 8-shot magazine; 3 13/16" barrel; 26 1/2 oz.; fixed sights; black plastic grips; cocked by pressure on frontstrap; large triggerguard with heat shield; oil-filled buffer to decrease recoil; blue or nickel finish. Introduced 1988; no longer imported.

Exc.: \$850 VGood: \$700 Good: \$600

22 LR conversion unit

Exc.: \$600 VGood: \$500 Good: \$400

32 ACP conversion unit

Exc.: \$300 VGood: \$200 Good: \$150

### HECKLER & KOCH P7 M8

Semi-automatic; 9mm Para.; 8-shot magazine; 4 1/8" barrel; 6 3/4" overall length; weighs 29 oz.; blade front, adjustable rear sight with three-dot system; unique "squeeze cocker" system in frontstrap; gas-retarded action; squared combat-type triggerguard; stippled black plastic grips; blue finish. Imported from Germany by Heckler & Koch, Inc.

Perf.: \$850 Exc.: \$750 VGood: \$650

### HECKLER & KOCH P7 M10

Semi-automatic; 40 S&W; 10-shot magazine; 4 1/8" barrel; 7" overall length; weighs 43 oz.; blade front, adjustable rear sight with three-dot system; unique "squeeze cocker" system in frontstrap; gas-retarded action; squared combat-type triggerguard; stippled black plastic grips; blue finish. Imported from Germany by Heckler & Koch, Inc. Introduced 1992; no longer in production.

Perf.: \$1000 Exc.: \$900 VGood: \$750

### HECKLER & KOCH P7 M13

Semi-automatic; single action; 9mm Para.; 13-shot magazine; 4 1/8" barrel; 6 1/2" overall length; 30 oz.; fixed sights; black plastic grips; cocked by pressure on frontstrap; large triggerguard with heat shield; ambi-

dextrous magazine release; blue or nickel finish. Introduced 1986; importation discontinued 1994.

Perf.: \$1250 Exc.: \$1100 VGood: \$1000

Nickel finish

Perf.: \$1350 Exc.: \$1150 VGood: \$1000

### HECKLER & KOCH P7 PSP

Semi-automatic; single action; 9mm Para.; 8-shot magazine; 4 1/8" barrel; 6 1/2" overall length; weighs 29 oz.; fixed sights; black plastic grips; cocked by pressure on frontstrap; squared combat triggerguard; blued finish. Imported from West Germany. Introduced 1982; discontinued 1986.

Perf.: \$800 Exc.: \$700 VGood: \$600

### HECKLER & KOCH P9S

Semi-automatic; double action; 9mm Para., 45 ACP; 9-shot magazine (9mm), 7-shot (45 ACP); 4" barrel; 5 7/16" overall length; fixed sights; checkered plastic grips; loaded/cocked indicators; hammer cocking lever; phosphated finish. Originally imported from Germany by Gold Rush Gun Shop in 1977, then by Heckler & Koch, Inc.; importation dropped 1984.

Exc.: \$800 VGood: \$700 Good: \$500

### Heckler & Koch P9S Competition Kit

Same specs as P9S except 9mm Para.; additional 5 1/2" barrel with weight; additional slide; adjustable sights; trigger; walnut stock. Introduced 1977; discontinued 1984.

Exc.: \$1300 VGood: \$950 Good: \$750

### Heckler & Koch P9S Target

Same specs as P9S except adjustable sights, trigger. Introduced 1977; discontinued 1984.

Exc.: \$900 VGood: \$750 Good: \$650

### HECKLER & KOCH SP 89

Semi-automatic; single action; 9mm Para.; 15-, 30-shot magazine; 4 1/2" barrel; 12 7/8" overall length; weighs 4 1/2 lbs.; black high-impact plastic grip; post front sight, fully-adjustable diopter rear; design inspired by the HK94 rifle; has special flash-hider forend. Imported from Germany by Heckler & Koch, Inc. Introduced 1989; no longer imported.

Perf.: \$3500 Exc.: \$3000 VGood: \$2500

Price: Blue \$685.00

Price: Blue with control lever on right \$706.00

Price: Stainless steel \$731.00

Price: Stainless steel with control lever on right

\$752.00





H&K USP 9mm



H&K P9S  
Competition Kit



H&K P7 PSB



H&K SP 89



H&K VP 70Z



Helwan 9mm



H&K USP Compact  
Auto Pistol



H&K USP45 Tactical



H&K USP45  
Compact

**HECKLER & KOCH USP 9/USP 40**

Semi-automatic; single action/double action or double-action-only; 9mm Para., 40 S&W; 16-shot magazine (9mm), 13-shot (40 S&W); 4 1/4" barrel; 6 15/16" overall length; weighs 28 oz. (USP40); non-slip stippled black polymer grips; blade front sight, windage-adjustable rear; polymer frame; modified Browning action with recoil reduction system; single control lever; special "hostile environment" finish on all metal parts; available in SA/DA, DAO, left- and right-hand versions. Imported from Germany by Heckler & Koch, Inc. Introduced 1993; still imported.

Right-hand	<b>New:</b> \$575	<b>Perf.:</b> \$500	<b>Exc.:</b> \$450
Left-hand	<b>New:</b> \$595	<b>Perf.:</b> \$550	<b>Exc.:</b> \$500

**Heckler & Koch USP Compact Auto Pistol**

Similar to the USP except has 3.58" barrel, measures 6.81" overall, and weighs 1.60 lbs. (9mm). Available in 9mm Para. or 40 S&W with 10-shot magazine. Introduced 1996. Imported from Germany by Heckler & Koch, Inc.

Right-hand	<b>New:</b> \$575	<b>Perf.:</b> \$500	<b>Exc.:</b> \$450
Left-hand	<b>New:</b> \$595	<b>Perf.:</b> \$550	<b>Exc.:</b> \$500

**Heckler & Koch USP 45**

Same specs as USP 9/USP 40 except 45 ACP; 10-shot magazine; 4 1/8" barrel; 7 7/8" overall length; weighs 30 oz.; adjustable three-dot sight system; available in SA/DA, DAO; left- and right-hand versions. Imported from Germany by Heckler & Koch, Inc. Introduced 1995; still imported.

Right-hand	<b>New:</b> \$625	<b>Perf.:</b> \$500	<b>Exc.:</b> \$450
Left-hand	<b>New:</b> \$650	<b>Perf.:</b> \$550	<b>Exc.:</b> \$500

**Heckler & Koch USP45 Compact**

Similar to the USP45 except has stainless slide; 8-shot magazine; modified and contoured slide and frame; extended slide release; 3.80" barrel, 7.09" overall length, weighs 1.75 lbs.; adjustable three-dot sights. Introduced 1998. Imported from Germany by Heckler & Koch, Inc.

Right-hand	<b>New:</b> \$625	<b>Perf.:</b> \$500	<b>Exc.:</b> \$450
Left-hand	<b>New:</b> \$650	<b>Perf.:</b> \$550	<b>Exc.:</b> \$500

**HECKLER & KOCH USP45 MATCH**

Semi-automatic; 45 ACP, 10-shot magazine. Barrel: 6.02. Weight: 2.38 lbs. Length: 9.45. Stocks: Textured polymer. Sights: High profile target front, fully adjustable target rear. Features: Adjustable trigger stop. Polymer frame, blue or stainless steel slide. Introduced 1997. Imported from Germany by Heckler & Koch, Inc.

Blue	<b>New:</b> \$1200	<b>Perf.:</b> \$1000	<b>Exc.:</b> \$850
Stainless	<b>New:</b> \$1250	<b>Perf.:</b> \$1050	<b>Exc.:</b> \$900

**HANDGUNS**

**Heckler & Koch**

USP 9/USP 40  
USP Compact Auto Pistol  
USP 45  
USP45 Compact  
USP45 Match  
USP45 Tactical  
VP 70Z

**HECKLER & KOCH USP45 TACTICAL**

Semi-automatic; 45 ACP, 10-shot magazine. Barrel: 4.92". Weight: 2.24 lbs. Length: 8.64" overall. Stocks: Non-slip stippled polymer. Sights: Blade front, fully adjustable target rear. Features: Has extended threaded barrel with rubber O-ring; adjustable trigger; extended magazine floorplate; adjustable trigger stop; polymer frame. Introduced 1998. Imported from Germany by Heckler & Koch, Inc.

<b>New:</b> \$850	<b>Perf.:</b> \$750	<b>Exc.:</b> \$650
-------------------	---------------------	--------------------

**HECKLER & KOCH VP 70Z**

Semi-automatic; double-action-only; 9mm Para.; 18-shot magazine; 4 1/2" barrel; 8" overall length; ramp front sight, channeled rear on slide; stippled black plastic stocks; recoil-operated; only four moving parts; double-column magazine; phosphated finish. Manufactured in West Germany. Introduced 1976; importation dropped 1989.

<b>Perf.:</b> \$450	<b>Exc.:</b> \$400	<b>VGood:</b> \$300
---------------------	--------------------	---------------------

# HANDGUNS

## Jennings

Model J-25  
Model M-38  
Model M-48

## Jericho

Model 941

## JSL

Spitfire

## Kahr

K9  
K9, K40  
KS40 Small Frame  
MK9 Micro-Compact

## Kareen

MKII Auto  
MKII Compact

## Kassnar

M-100D  
Model M-100TC



Kahr MK9 Micro Compact Pistol



Kahr K9



Jericho Model 941



Kareen MKII Auto Pistol



Jennings Model J-25



Kassnar M-100D

### JENNINGS MODEL J-25

Semi-automatic; 25 ACP; 6-shot magazine; 2 1/2" barrel; weighs 12 oz.; 4 15/16" overall length; fixed sights; synthetic walnut or black combat-style grips. Introduced 1981; still in production.

Perf.: \$65 Exc.: \$50 VGood: \$40

### JENNINGS MODEL M-38

Semi-automatic; 22 LR, 32 ACP, 380 ACP; 2 13/16" barrel; weighs 16 oz.; non-ferrous alloy construction; black grips; chrome or blue finish.

Perf.: \$75 Exc.: \$60 VGood: \$50

### JENNINGS MODEL M-48

Semi-automatic; 22 LR, 32 ACP, 380 ACP; 4" barrel; weighs 24 oz.; non-ferrous alloy construction; black grips; chrome or blue finish. Introduced 1995.

Perf.: \$75 Exc.: \$60 VGood: \$50

### JERICHO MODEL 941

Semi-automatic; double action; 9mm Para.; 16-shot magazine; 4 3/8" barrel; 8 1/8" overall length; weighs 33 oz.; high impact black polymer grips; blade front sight, windage-adjustable rear; three tritium dots; all steel construction; polygonal rifling; ambidextrous safety. Produced in Israel by Israel Military Industries; distributed by K.B.I., Inc. Introduced 1990; dropped 1991.

Perf.: \$450 Exc.: \$375 VGood: \$300

### JSL SPITFIRE

Semi-automatic; double action; 9mm Para.; 15-shot magazine; 4 3/8" barrel; 8 7/8" overall length; weighs 40 oz.; textured composition grips; blade front sight, fully-adjustable rear; stainless steel construction; ambidextrous safety. Imported from England by Rogers Ltd. International. Introduced 1992; importation dropped 1993.

Perf.: \$1200 Exc.: \$900 VGood: \$750

### KAHR K9

Semi-automatic; double action; 9mm Para.; 7-shot magazine; 3 1/2" barrel; 6" overall length; weighs 25 oz.; wrap-around textured soft polymer grips; blade front sight, windage drift-adjustable rear; bar-dot combat style; passive firing pin block; made of 4140 ordnance

steel; matte black finish. Made in U.S. by Kahr Arms. Introduced 1994; still produced. LMSR: \$595

New: \$500 Perf.: \$425 Exc.: \$350

### KAHR K9, K40

Semi-automatic; double action; 9mm Para.; 7-shot magazine; 40 S&W; 6-shot magazine; 3 1/2" barrel; 6" overall length; weighs 25 oz.; wrap-around textured soft polymer grips; blade front sight, windage drift-adjustable rear; bar-dot combat style; passive firing pin block; made of 4140 ordnance steel; matte black finish. Made in U.S. by Kahr Arms. Many sight, finish options. Introduced 1994; still produced.

New: \$500 Perf.: \$425 Exc.: \$350

### Kahr KS40 Small Frame

Same as standard K40 except 1/2" shorter grip. Comes with one 5-shot, one 6-shot magazine. Introduced 1998. Made in U.S. by Kahr Arms.

New: \$550 Perf.: \$475 Exc.: \$400

With night sights. \$677.00

New: \$600 Perf.: \$525 Exc.: \$450

### Kahr MK9 Micro-Compact

Similar to the K9 except is 5.5" overall, 4" high, has a 3" barrel. Weighs 22 oz. Has snag-free bar-dot sights, polished feed ramp, dual recoil spring system, DA-only trigger. Comes with 6- and 7-shot magazines. Introduced 1998.

Matte stainless

New: \$550 Perf.: \$475 Exc.: \$400

Matte stainless, tritium night sights

New: \$650 Perf.: \$575 Exc.: \$500

Duo-Tone (stainless frame, Black-T slide)

\$749.00

New: \$700 Perf.: \$600 Exc.: \$500

Duo-Tone with tritium night sights \$836.00  
New: \$775 Perf.: \$675 Exc.: \$600

### KAREEN MKII AUTO

Semi-automatic; single action; 9mm Para.; 13 (now 10)-shot magazine; 4 3/4" barrel; 8" overall length; weighs 32 oz.; blade front sight, windage-adjustable rear; checkered European walnut grips (early model), rubberized grips (later versions); blued finish, two-tone or matte black finish, optional. Made in Israel. Introduced 1969 by Century International Arms, Inc.; still imported by J.O. Arms.

Perf.: \$350 Exc.: \$275 VGood: \$225

### Kareen MKII Compact

Same specs as MKII except 3 1/4" barrel; 6 1/2" overall length; weighs 28 oz.; rubber grips. Introduced 1995; still in production.

New: \$350 Exc.: \$300 VGood: \$275

### KASSNAR M-100D

Revolver; double action; 22 LR, 22 WMR, 38 Spl.; 6-shot cylinder; 3", 4", 6" barrels; target-style checkered hardwood stocks; elevation-adjustable rear sight, ramp front; vent-rib barrel. Manufactured in the Philippines by Squires Bingham; imported by Kassnar. Introduced 1977; no longer imported.

Exc.: \$125 VGood: \$110 Good: \$100

### KASSNAR MODEL M-100TC

Revolver; double action; 22 LR, 22 WMR, 38 Spl.; 6-shot cylinder; 3", 4", 6" barrels; full ejector rod shroud; target-style checkered hardwood stocks; elevation-adjustable rear sight, ramp front; vent-rib barrel. Manufactured in the Philippines by Squires Bingham; imported by Kassnar. Introduced 1977; no longer imported.

Exc.: \$135 VGood: \$125 Good: \$110



# HANDGUNS

**Kassnar**  
PJK-9HP

**KBI**  
PSP-25

**KEL-TEC**  
P-11

**Kimber**

Classic 45 Custom  
Classic 45 Gold Match  
Classic 45 Polymer Frame  
Classic 45 Royal  
Compact 45  
Custom Target



Kassnar PJK-9HP



Kel-Tec P-11



Kimber Classic 45 Custom



KBI PSP-25



Kimber Classic 45 Polymer Frame



Kimber Classic 45



Kimber Classic 45 Gold Match



Kimber Custom Target

## KASSNAR PJK-9HP

Semi-automatic; single action; 9mm Para.; 13-shot magazine; 4 3/4" barrel; 8" overall length; weighs 32 oz.; adjustable rear sight, ramp front; checkered European walnut stocks; with or without full-length vent rib. Made in Hungary. Introduced 1986; no longer imported.

**Perf.:** \$225 **Exc.:** \$175 **VGood:** \$165

## KBI PSP-25

Semi-automatic; single action; 25 ACP; 6-shot magazine; 2 1/8" barrel; 4 1/8" overall length; weighs 9 1/2 oz.; fixed sights; checkered black plastic grips; all-steel construction; polished blue or chrome finish. Close copy of Browning Baby 25 made under F.N. license. Introduced 1990; no longer in production.

**Perf.:** \$180 **Exc.:** \$160 **VGood:** \$140

## KEL-TEC P-11

Semi-automatic; double-action-only; 9mm Para.; 10-shot magazine; 3 1/8" barrel; 5 9/16" overall length; weighs 14 oz.; checkered black polymer grips; blade front sight, windage-adjustable rear; ordnance steel slide, aluminum frame; blue finish. Made in U.S. by Kel-Tec CNC Industries, Inc. Introduced 1995; still produced.

**New:** \$250 **Perf.:** \$225 **Exc.:** \$200

Electroless nickel finish

**New:** \$350 **Perf.:** \$300 **Exc.:** \$235

Gray finish

**New:** \$280 **Perf.:** \$250 **Exc.:** \$200

## KIMBER CLASSIC 45 CUSTOM

Semi-automatic; single action; 45 ACP; 8-shot magazine; 5" barrel; 8 1/2" overall length; weighs 38 oz.; checkered hard synthetic grips; McCormick dovetailed front sight, low combat rear; Chip McCormick Corp. forged frame and slide; match barrel; extended combat thumb safety; high beavertail grip safety; skeletonized lightweight composite trigger; skeletonized

Commander-type hammer; elongated Commander ejector; bead-blasted black oxide finish; flat main-spring housing; short guide rod; lowered and flared ejection port; serrated front and rear of slide; relief cut under trigger guard; Wolff spring set; beveled magazine well. Made in U.S. by Kimber of America, Inc. Introduced 1995; still produced.

**New:** \$550 **Perf.:** \$500 **Exc.:** \$425

Custom stainless

**New:** \$700 **Perf.:** \$650 **Exc.:** \$500

## Kimber Classic 45 Gold Match

Same specs as Custom except long guide rod; polished blue finish; Bo-Mar BMCS low-mount adjustable rear sight; fancy walnut grips; tighter tolerances; comes with one 10-shot and one 8-shot magazine, factory proof target. Made in U.S. by Kimber of America, Inc. Introduced 1995; still produced.

**New:** \$900 **Perf.:** \$800 **Exc.:** \$700

## Kimber Classic 45 Polymer Frame

Similar to the Classic 45 Custom except has black polymer frame with stainless steel insert, hooked trigger guard, checkered front strap. Weighs 34.4 oz., overall length 8.75". Introduced 1997.

**New:** \$750 **Perf.:** \$675 **Exc.:** \$600

Polymer Stainless \$948.00

**New:** \$850 **Perf.:** \$675 **Exc.:** \$650

Polymer Target \$957.00

**New:** \$850 **Perf.:** \$675 **Exc.:** \$650

Polymer Stainless Target \$1,036.00

**New:** \$900 **Perf.:** \$800 **Exc.:** \$700

## Kimber Classic 45 Royal

Same specs as the Custom model except has checkered diamond-pattern walnut grips; long guide rod; polished blue finish; comes with two 8-shot maga-

zines. Made in U.S. by Kimber of America, Inc. Introduced 1995; still produced.

**New:** \$650 **Perf.:** \$600 **Exc.:** \$500

## Kimber Compact 45

Similar to the Classic Custom except has 4" barrel fitted directly to the slide with no bushing; full-length guide rod; 7-shot magazine; grip is .400" shorter than full-size guns. Weighs 34 oz.; Compact Aluminum weighs 28 oz. Introduced 1998.

**New:** \$600 **Perf.:** \$500 **Exc.:** \$400

Compact Stainless

**New:** \$700 **Perf.:** \$600 **Exc.:** \$500

Compact Aluminum

**New:** \$600 **Perf.:** \$500 **Exc.:** \$400

## KIMBER CUSTOM TARGET

Caliber: 45 ACP, 7-shot magazine. Barrel: 5. Weight: 38 oz. Length: 8.7 overall. Stocks: Black synthetic. Sights: Blade front, Kimber fully adjustable rear; dove-tailed. Features: Match trigger; beveled front and rear slide serrations; lowered, flared ejection port; full-length guide rod; Wolff springs. Introduced 1996.

Custom Target

**New:** \$650 **Perf.:** \$600 **Exc.:** \$500

Stainless Target

**New:** \$800 **Perf.:** \$700 **Exc.:** \$625

# HANDGUNS

## Korth

Semi-Automatic  
Semi-Auto

## Lahti

Finnish Model L-35  
Swedish Model 40

## L.A.R.

Grizzly Win. Mag. Mark I  
Grizzly Win. Mag. Mark I, 8<, 10<  
Grizzly Win. Mag. Mark II  
Grizzly 44 Mag. Mark IV  
Grizzly 50 Mark V

## Laseraim Arms

Series I  
Series II  
Series III



Lahti Swedish Model 40



Lahti Finnish Model L-35



L.A.R. Grizzly Win. Mag. Mark I



L.A.R. Grizzly 50 Mark V



Laseraim Arms Series III



Korth Semi-Auto

### KORTH SEMI-AUTOMATIC

Semi-automatic; double-action; 9mm Para., 9x21; 10-shot; 4", 5", 6" barrel; 10 1/2" overall length; weighs 35 oz.; forged, machined frame and slide; adjustable combat sights; checkered walnut stocks; matte or polished finish. Introduced 1985; dropped 1989. Now imported from Germany Korth U.S.A.

Perf.: \$2750 Exc.: \$2500 VGood: \$2000

### KORTH SEMI-AUTO

Semi-automatic; double action; 9mm Para. (10-shot), 40 S&W (9-shot). Barrel: 4", 5". Weight: NA. Length: NA. Stocks: Checkered walnut. Sights: Ramped front, fully adjustable rear. Features: Forged steel construction; double action; locked breech; recoil operated. Imported from Germany by Korth U.S.A.

High-polish blued finish

New: \$6000 Perf.: \$5500 Exc.: \$4500

Plasma-coated matte silver finish

New: \$7000 Perf.: \$6500 Exc.: \$6000

Plasma-coated high-polish silver finish

New: \$7500 Perf.: \$7000 Exc.: \$6500

### LAHTI FINNISH MODEL L-35

Semi-automatic; 9mm Para.; 8-shot magazine; 4 3/4" barrel; fixed sights; checkered plastic stocks; blued finish. Manufactured on a limited basis in Finland from 1935 to 1954.

Exc.: \$1200 VGood: \$950 Good: \$800

### LAHTI SWEDISH MODEL 40

Semi-automatic; 9mm Para.; 8-shot magazine; 4 3/4" barrel; fixed sights; checkered plastic stocks; blued finish. Manufactured in Sweden by Husqvarna. Manufactured 1942 to 1946.

Exc.: \$375 VGood: \$300 Good: \$250

### L.A.R. GRIZZLY WIN. MAG. MARK I

Semi-automatic; single action; 30 Mauser, 357 Mag., 357/45 Grizzly Win. Mag., 10mm, 45 ACP, 45 Win. Mag.; 7-shot magazine; 5 1/2", 6 1/2" barrel; 10 5/8" overall length; weighs 51 oz.; ramped blade front, adjustable rear sight; no-slip rubber combat grips; ambidextrous safeties; conversion units 45 to 357 Mag., 45 ACP, 10mm, 45 Win. Mag. available; phosphated finish. Introduced 1984; dropped 1999.

Perf.: \$850 Exc.: \$750 VGood: \$575

### L.A.R. Grizzly Win. Mag. Mark I, 8", 10"

Same specs as Mark I standard except 8", 10" barrel; lengthened slide. Introduced 1984; dropped 1999.

Perf.: \$1200 Exc.: \$1000 VGood: \$900

10" barrel

Perf.: \$1250 Exc.: \$1100 VGood: \$950

### L.A.R. Grizzly Win. Mag. Mark II

Same specs as the Grizzly Win. Mag. Mark I except fixed sights; standard safeties. Introduced 1986; discontinued 1986.

Perf.: \$550 Exc.: \$450 VGood: \$400

### L.A.R. GRIZZLY 44 MAG. MARK IV

Semi-automatic; single action; 44 Mag.; 7-shot magazine; 5 1/2", 6 1/2" barrel; 10 5/8" overall length; weighs 51 oz.; ramped blade front, adjustable rear sight; no-slip rubber combat grips; beavertail grip safety; matte blue, hard chrome, chrome or nickel finish. Introduced 1991; dropped 1999.

Perf.: \$750 Exc.: \$650 VGood: \$575

Hand chrome, chrome or nickel finish

Perf.: \$850 Exc.: \$750 VGood: \$650

### L.A.R. GRIZZLY 50 MARK V

Semi-automatic; single action; 50 AE; 6-shot magazine; 5 1/2", 6 1/2" barrel; 10 5/8" overall length; weighs 56 oz.; ramped blade front, adjustable rear sight; no-slip rubber combat grips; ambidextrous safeties; conversion units available; phosphated finish. Made in U.S. by L.A.R. Mfg., Inc. Introduced, 1993; dropped 1999.

New: \$900 Perf.: \$850 Exc.: \$750

### LASERAIM ARMS SERIES I

Semi-automatic; single action; 10mm Auto, 45 ACP; 8-shot magazine (10mm), 7-shot (45 ACP); 4 3/8", 6" barrel, with compensator; 9 3/4" overall length (6" barrel); weighs 46 oz.; pebble-grained black composite grips; blade front sight, fully-adjustable rear; barrel compensator; stainless steel construction; ambidextrous safety-levers; extended slide release; integral mount for laser sight; matte black Teflon finish. Made in U.S. by Emerging Technologies, Inc. Introduced 1993; dropped 1999.

New: \$400 Perf.: \$350 Exc.: \$300

With adjustable sight

New: \$450 Perf.: \$400 Exc.: \$350

With fixed sight and Auto Illusion red dot sight system

New: \$650 Perf.: \$600 Exc.: \$550

With fixed sight and Laseraim Laser with Hotdot

New: \$750 Perf.: \$700 Exc.: \$650

### LASERAIM ARMS SERIES II

Semi-automatic; single action; 10mm Auto, 45 ACP, 40 S&W; 8-shot magazine (10mm), 7-shot (45 ACP); 3 3/8", 5" barrel without compensator; weighs 43 oz. (5"), 37 oz. (3 3/8"); pebble-grained black composite grips; blade front sight, fixed or windage-adjustable rear; stainless steel construction; ambidextrous safety-levers; extended slide release; integral mount for laser sight; matte stainless finish. Made in U.S. by Emerging Technologies, Inc. Introduced 1993; dropped 1999.

New: \$450 Perf.: \$400 Exc.: \$350

With adjustable sight (5" barrel)

New: \$475 Perf.: \$425 Exc.: \$375

With fixed sight and Auto Illusion red dot sight

New: \$500 Perf.: \$425 Exc.: \$400

With fixed sight and Laseraim Laser with Hotdot

New: \$550 Perf.: \$475 Exc.: \$450

### LASERAIM ARMS SERIES III

Semi-automatic; single action; 10mm Auto, 45 ACP; 8-shot magazine (10mm), 7-shot (45 ACP); 5" barrel with dual-port compensator; 7 5/8" overall length; weighs 43 oz.; pebble-grained black composite grips; blade front sight, fixed or windage-adjustable rear; stainless steel construction; ambidextrous safety-levers; extended slide release; integral mount for laser sight; matte stainless finish. Made in U.S. by Emerging Technologies, Inc. Introduced 1994; dropped 1999.

With fixed sight

New: \$500 Perf.: \$450 Exc.: \$400

With adjustable sight

New: \$525 Perf.: \$475 Exc.: \$425

With fixed sight and Dream Team Laseraim laser sight

New: \$600 Perf.: \$550 Exc.: \$500





Liberty Mustang



Les Incorporated Rogak P-18



Le Francais Pocket Model



Le Francais Policeman Model

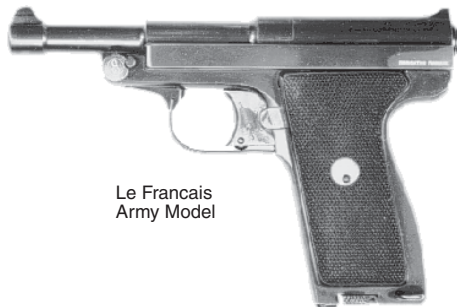

Le Francais Army Model



Lignose Model 3A Einhand

#### LASERAIM ARMS SERIES IV

Semi-Automatic; 45 ACP; 7-shot magazine; 3 3/8", 5" barrel; weighs 37 oz.; full serrated slide; diamond wood grips; stainless steel construction; blade front, fully-adjustable rear sight; ambidextrous safety levers; integral mount for laser sight. Made in U.S. by Emerging Technologies, Inc. Introduced 1996; dropped 1999.

New: \$600 Perf.: \$550 Exc.: \$500

#### LE FRANCAIS ARMY MODEL

Semi-automatic; double action; 9mm Browning Long; 8-shot magazine; 5" flip up barrel; 7 3/4" overall length; fixed sights; checkered European walnut stocks; blued finish. Manufactured 1928 to 1938.

Exc.: \$1200 VGood: \$1000 Good: \$700

#### LE FRANCAIS POCKET MODEL

Semi-automatic; double action; 32 ACP; 7-shot magazine; 3 1/2" flip-up barrel; 6" overall length; fixed sights; checkered hard rubber stocks; blued finish. Manufactured in France. Introduced 1950; discontinued 1965. Rare in the U.S.

Exc.: \$750 VGood: \$600 Good: \$450

#### LE FRANCAIS POLICEMAN MODEL

Semi-automatic; double action; 25 ACP; 7-shot magazine; 2 1/2", 3 1/2" flip up barrel; fixed sights; hard rubber stocks; blued finish. Introduced 1914; discontinued about 1960.

Exc.: \$250 VGood: \$225 Good: \$185

#### LES INCORPORATED ROGAK P-18

Semi-automatic; double action; 9mm Para.; 18-shot magazine; 5 1/2" barrel; post front sight, V-notch rear, drift adjustable for windage; checkered resin stocks; stainless steel; matte or deluxe high gloss finishes. Introduced 1977; discontinued 1981.

Exc.: \$400 VGood: \$350 Good: \$300

Deluxe high gloss finish

Exc.: \$450 VGood: \$400 Good: \$350

#### LIBERTY MUSTANG

Revolver; single action; 22 LR, 22 WMR or combo; 8-shot cylinder; 5" barrel; 10 1/2" overall length; weighs 34 oz.; blade front, adjustable rear sight; smooth rosewood grips; side ejector rod; blued finish. Imported from Italy by Liberty. Introduced 1976; discontinued 1980.

Exc.: \$150 VGood: \$135 Good: \$110

#### LIGNOSE MODEL 2 POCKET

Semi-automatic; 25 ACP; 6-shot magazine; 2" barrel; 4 1/2" overall length; checkered hard rubber stocks; blued finish. Manufactured in Germany from 1920 first under Bergmann name, then Lignose to late 1920s.

Exc.: \$200 VGood: \$175 Good: \$150

#### Lignose Model 2A Einhand

Same specs as Model 2 Pocket except sliding trigger guard allows slide retraction with trigger finger.

Exc.: \$350 VGood: \$250 Good: \$200

#### LIGNOSE MODEL 3 POCKET

Semi-automatic; 25 ACP; 9-shot magazine; 2" barrel; 4 1/2" overall length; checkered hard rubber stocks; blued finish. Manufactured in Germany.

Exc.: \$225 VGood: \$200 Good: \$150

#### Lignose Model 3A Einhand

Same specs as Model 3 Pocket except sliding trigger guard allows slide retraction with trigger finger.

Exc.: \$300 VGood: \$300 Good: \$250

#### LILIPUT 4.25

Semi-automatic; 4.25mm; 6-shot; 1 13/16" barrel; 3 1/2" overall length; weighs 8 oz.; blue or nickel finish. Made by August Menz, Suhl, Germany. Introduced 1920.

Exc.: \$800 VGood: \$700 Good: \$550

#### LILIPUT 25 ACP

Semi-automatic; 25 ACP; 6-shot; 2" barrel; 4 1/8" overall length; weighs 10 oz.; blue or nickel finish.

## HANDGUNS

### Laseraim Arms

Series IV  
Le Francais  
Army Model  
Pocket Model  
Policeman Model

### Les Incorporated

Rogak P-18

### Liberty

Mustang

### Lignose

Model 2 Pocket  
Model 2A Einhand  
Model 3 Pocket  
Model 3A Einhand

### Liliput

4.25  
25 ACP

### Ljutic

LJ II  
Space Pistol

### Llama

IIIA Small Frame



Liliput 4.25

Made by August Menz, Suhl Germany. Introduced 1925.

Exc.: \$250 VGood: \$200 Good: \$150

#### LJUTIC LJ II

Derringer; double action; 22 WMR; 2-shot; 2 3/4" side-by-side barrels; fixed sights; checkered walnut stocks; vent rib; positive safety; stainless steel construction. Introduced 1981; dropped 1989. About 1000 produced.

Perf.: \$1500 Exc.: \$1200 VGood: \$1000

#### LJUTIC SPACE PISTOL

Single shot; bolt action; 22 WMR, 357 Mag., 44 Mag., 308 Win.; 13 1/2" barrel; scope mounts; American walnut grip, forend; button trigger; Introduced 1981; prototype only.

#### LLAMA IIIA SMALL FRAME

Semi-automatic; single action; 380 ACP, 32 ACP (disc. 1993); 7-shot magazine; 3 11/16" barrel; 6 1/2" overall length; weighs 23 oz.; adjustable target sights; checkered thumbrest plastic grips; vent rib; grip safety; loaded chamber indicator; blued, chrome engraved, blue engraved or gold engraved finishes. Early versions were sans vent rib, had lanyard ring, no thumbrest on grips. Introduced 1951; still in production.

# HANDGUNS

## Llama

VIII

IX Large Frame

IX-A Large Frame

IX-B Compact Frame

IX-C New Generation Large Frame

IX-D New Generation Compact Frame

XA Small Frame

XI

XV Small Frame



Llama IIIA Small Frame



Llama IX-C  
New Generation  
Large Model



Llama VIII



Llama XI  
Large Frame

Blued finish

Perf.: \$250 Exc.: \$200 VGood: \$175

Chrome engraved

Perf.: \$275 Exc.: \$225 VGood: \$200

Blue engraved

Perf.: \$275 Exc.: \$225 VGood: \$200

Gold engraved

Perf.: \$500 Exc.: \$450 VGood: \$400

### LLAMA VIII

Semi-automatic; 38 Super; 9-shot magazine; 5" barrel; 8 1/2" overall length; fixed sights; hand-checked walnut grips; vent rib; grip safety; blued, chrome, chrome engraved or blued engraved finishes. Imported by Stoeger. Introduced 1952; no longer in production.

Perf.: \$275 Exc.: \$250 VGood: \$225

Chrome finish

Perf.: \$300 Exc.: \$275 VGood: \$250

Chrome engraved

Perf.: \$325 Exc.: \$300 VGood: \$275

Blue engraved

Perf.: \$300 Exc.: \$250 VGood: \$225



Ljutic LJII



Llama XV  
Small Frame

### LLAMA IX LARGE FRAME

Semi-automatic; single action; 9mm, 38 Super, 45 ACP; 9-shot magazine (9mm, 38 Super), 7-shot (45 ACP); 5 1/8" barrel; 41 oz.; adjustable sights; black plastic grips; blued or satin chrome finish. Introduced 1936; no longer imported.

Perf.: \$325 Exc.: \$275 VGood: \$225

Satin chrome finish

Perf.: \$350 Exc.: \$300 VGood: \$250

### LLAMA IX-A LARGE FRAME

Semi-automatic; 45 ACP; 7-shot magazine; 5 1/8" barrel; 8 1/2" overall length; weighs 36 oz.; hand-checked walnut grips; vent rib; fixed sights; grip safety; loaded chamber indicator; blue, chrome, chrome engraved or blue engraved finishes. Introduced 1952; still imported as IX-C New Generation Large Frame.

Perf.: \$375 Exc.: \$325 VGood: \$275

Chrome finish

Perf.: \$400 Exc.: \$350 VGood: \$300

Chrome engraved

Perf.: \$450 Exc.: \$400 VGood: \$350

Blue engraved

Perf.: \$400 Exc.: \$350 VGood: \$300

### LLAMA IX-B COMPACT FRAME

Semi-automatic; single action; 45 ACP; 7-shot magazine; 4 1/4" barrel; 7 7/8" overall length; weighs 34 oz.; checkered polymer grips; blade front sight, fully-adjustable rear; scaled-down version of Llama Large Frame; locked breech mechanism; manual and grip safeties; blue or chrome finish. Imported from Spain by SGS Importers Intl., Inc. Introduced 1985; still imported as IX-D model.

Perf.: \$300 Exc.: \$250 VGood: \$225

Chrome finish

Perf.: \$325 Exc.: \$275 VGood: \$250



Llama Comanche

### LLAMA IX-C NEW GENERATION LARGE FRAME

Semi-automatic; single action; 45 ACP; 13-shot magazine; 5 1/8" barrel; 8 1/2" overall length; 41 oz.; three-dot combat sights; military-style hammer; loaded chamber indicator; anatomically designed rubber grips; non-glare matte finish. Introduced 1994; Converted to 10-shot magazine 1995; still in production.

New: \$350 Perf.: \$300 Exc.: \$250

### LLAMA IX-D NEW GENERATION COMPACT FRAME

Semi-automatic; single action; 45 ACP; 13-shot; 4 1/4" barrel; 7 7/8" overall length; weighs 39 oz.; three-dot combat sights; rubber grips; non-glare matte finish. Converted to 10-shot 1995; still in production.

New: \$350 Perf.: \$300 Exc.: \$250

### LLAMA XA SMALL FRAME

Semi-automatic; 32 ACP; 7-shot magazine; 3 11/16" barrel; 6 1/2" overall length; adjustable target sights; checkered thumbrest plastic grips; grip safety; blued, chrome engraved or blue engraved finishes; successor to Llama X which had no grip safety. Imported by Stoeger. Introduced 1951; no longer in production.

Exc.: \$200 VGood: \$175 Good: \$150

Chrome engraved

Exc.: \$225 VGood: \$200 Good: \$150

Blue engraved

Exc.: \$225 VGood: \$200 Good: \$175

### LLAMA XI

Semi-automatic; 9mm Para.; 8-shot magazine; 5" barrel; 8 1/2" overall length; adjustable sights; checkered thumbrest; plastic grips; vent rib; blued, chrome, chrome engraved or blued engraved finishes.



Llama XV  
Small Frame

Imported by Stoeger Arms. Introduced 1954; no longer in production.

Perf.: \$275 Exc.: \$250 VGood: \$200

Chrome finish

Perf.: \$300 Exc.: \$275 VGood: \$250

Chrome engraved

Perf.: \$325 Exc.: \$300 VGood: \$275

Blue engraved

Perf.: \$325 Exc.: \$300 VGood: \$275

### LLAMA XV SMALL FRAME

Semi-automatic; 22 LR; 8-shot magazine; 3 11/16" barrel; 6 1/2" overall length; weighs 23 oz.; adjustable target sights; checkered thumbrest plastic grips; vent rib; grip safety; blued, chrome engraved or blue engraved finishes. Introduced 1951; no longer in production.

Perf.: \$225 Exc.: \$200 VGood: \$175

Chrome engraved

Perf.: \$250 Exc.: \$225 VGood: \$200

Blue engraved

Perf.: \$250 Exc.: \$225 VGood: \$200



# HANDGUNS

## Llama

Comanche  
Comanche I  
Comanche II  
Comanche III  
Martial  
Martial Deluxe  
Max-I Auto Pistols  
Max-I New Generation  
Max-I New Generation  
Compact Frame  
Micromax 380 Auto Pistol  
Minimax Series  
Minimax-II Auto Pistol  
Model 82



Llama Martial



Llama Minimax Series



Llama Max-I



Llama IIIA Small Frame



Llama IIIA Small Frame



Llama IIIA Small Frame

### LLAMA COMANCHE

Revolver; double action; 22 LR, 357 Mag.; 6-shot cylinder; 4", 6" barrel; 9 1/4" overall length (4" barrel); weighs 28 oz.; blade front sight, fully-adjustable rear; checkered walnut stocks; ventilated rib; wide spur hammer; blue finish. Was imported from Spain by SGS Importers International, Inc. No longer imported.

Exc.: \$200 VGood: \$175 Good: \$150

### LLAMA COMANCHE I

Revolver; double action; 22 LR; 6-shot cylinder; 6" barrel; 11 1/4" overall length; target-type sights; checkered walnut stocks; blued finish. Introduced in 1977, replacing Martial 22 model; discontinued 1982.

Exc.: \$200 VGood: \$175 Good: \$150

### Llama Comanche II

Same specs as Comanche I except 38 Spl.; 4" barrel. Introduced 1977; discontinued 1982.

Exc.: \$175 VGood: \$150 Good: \$135

### Llama Comanche III

Same specs as Comanche I except 22 LR, 357 Mag.; 4", 6", 8 1/2" barrel; 9 1/4" overall length; ramp front, adjustable rear sight; blued, satin chrome or gold finish. Introduced in 1977 as "Comanche"; renamed 1977; no longer in production.

Perf.: \$250 Exc.: \$225 VGood: \$200

Satin chrome finish

Perf.: \$275 Exc.: \$250 VGood: \$225

Gold finish

Perf.: \$750 Exc.: \$650 VGood: \$500

### LLAMA MARTIAL

Revolver; double action; 22 LR, 38 Spl.; 6-shot cylinder; 4" barrel (38 Spl.), 6" (22 LR); 11 1/4" overall length (6" barrel); target sights; hand-checkered walnut grips; blued finish. Imported by Stoeger. Introduced 1969; discontinued 1976.

Exc.: \$200 VGood: \$175 Good: \$150

### Llama Martial Deluxe

Same specs as Martial model except choice of satin chrome, chrome engraved, blued engraved, gold

engraved finishes; simulated pearl stocks.

Satin chrome finish

Exc.: \$250 VGood: \$200 Good: \$150

Chrome engraved

Exc.: \$275 VGood: \$225 Good: \$175

Blue engraved

Exc.: \$275 VGood: \$225 Good: \$175

Gold engraved

Exc.: \$750 VGood: \$600 Good: \$500

### LLAMA MAX-I NEW GENERATION LARGE FRAME

Semi-automatic; single action; 9mm Para., 45 ACP; 9-shot magazine (9mm), 7-shot (45 ACP); 5 1/8" barrel; 8 1/2" overall length; weighs 36 oz.; blade front sight, windage-adjustable rear; black rubber grips; three-dot system; skeletonized combat-style hammer; steel frame; extended manual and grip safeties; blue or duo-tone finish. Imported from Spain by Import Sports, Inc. Introduced 1995; still imported.

New: \$250 Perf.: \$200 Exc.: \$175

Duo-tone finish

New: \$325 Perf.: \$300 Exc.: \$250

### Llama Max-I New Generation Compact Frame

Same specs as the Max-I except 7-shot; 4 1/4" barrel; 7 7/8" overall length; weighs 34 oz. Imported from Spain by Import Sports, Inc.

Introduced 1995; still imported.

New: \$300 Perf.: \$275 Exc.: \$225

Duo-tone finish

New: \$350 Perf.: \$325 Exc.: \$300

### LLAMA MICROMAX 380 AUTO

Semi-automatic; 380 ACP, 7-shot magazine. Barrel: 3-11/16". Weight: 23 oz. Length: 6-1/2" overall. Stocks: Checkered high impact polymer. Sights: 3-dot combat. Features: Single action design. Mini custom

extended slide release; mini custom extended beaver-tail grip safety; combat-style hammer. Introduced 1997. Imported from Spain by Import Sports, Inc.

New: \$200 Perf.: \$175 Exc.: \$150

Satin chrome \$281.95

New: \$225 Perf.: \$250 Exc.: \$225

### LLAMA MINIMAX SERIES

Semi-automatic; 9mm Para., 8-shot; 40 S&W, 7-shot; 45 ACP, 6-shot magazine. Barrel: 3-1/2". Weight: 35 oz. Length: 7-1/3" overall. Stocks: Checkered rubber. Sights: Three-dot combat. Features: Single action, skeletonized combat-style hammer, extended slide release, cone-style barrel, flared ejection port. Introduced 1996. Imported from Spain by Import Sports, Inc.

New: \$250 Perf.: \$225 Exc.: \$175

Duo-tone finish (45 only) or satin chrome

New: \$275 Perf.: \$250 Exc.: \$200

### Llama Minimax-II Auto

Same as the Minimax except in 45 ACP only, with 10-shot staggered magazine. Introduced 1997. Imported from Spain by Import Sports, Inc.

New: \$300 Perf.: \$275 Exc.: \$225

Satin chrome

New: \$325 Perf.: \$300 Exc.: \$250

### LLAMA MODEL 82

Semi-automatic; double action; 9mm Para.; 15-shot magazine; 4 1/4" barrel; 8" overall length; weighs 39 oz.; blade-type front sight, drift-adjustable rear; 3-dot system; matte black polymer stocks; ambidextrous safety; blued finish. Made in Spain. Introduced 1987; discontinued 1993.

Perf.: \$650 Exc.: \$600 VGood: \$550

# HANDGUNS

## Llama

Model 87 Competition Model  
Omni  
Super Comanche IV  
Super Comanche V

## Lorcin

L-9mm  
L-22  
L-25  
L-32  
L-380  
LH-380  
LT-25

## Luger

Model 1900 Commercial  
Model 1900 Swiss



Llama Super Comanche IV



Llama Omni



Lorcin L-9mm



Lorcin L-22



Lorcin L-25



Luger Model 1900 Commercial

### LLAMA MODEL 87 COMPETITION MODEL

Semi-automatic; 9mm Para.; 14-shot magazine; 6" barrel; 9 1/2" overall length; weighs 47 oz.; Patridge-type front sight, fully-adjustable rear; Polymer composition stocks; built-in ported compensator; oversize magazine, safety releases; fixed barrel bushing; extended triggerguard; beveled magazine well. Made in Spain. Introduced 1989; discontinued 1993.

Perf.: \$900 Exc.: \$750 VGood: \$600

### LLAMA OMNI

Semi-automatic; double action; 9mm Para., 45 ACP; 13-shot magazine (9mm), 7-shot (45 ACP); 4 1/4" barrel; 7 3/4" overall length (45 ACP), 8" (9mm); weighs 40 oz.; adjustable sights; checkered plastic stocks; ball-bearing action; double sear bars; articulated firing pin; low-friction rifling; blued finish. Made in Spain. Introduced 1982; dropped 1986.

Exc.: \$350 VGood: \$300 Good: \$275

### LLAMA SUPER COMANCHE IV

Revolver; double action; 44 Mag.; 6-shot cylinder; 6", 8 1/2" barrel; adjustable sights; oversize walnut grips; wide hammer, trigger; blued finish. No longer imported.

Perf.: \$325 Exc.: \$275 VGood: \$250

### Llama Super Comanche V

Same specs as Super Comanche IV except 357 Mag. only; 4" barrel also available. Discontinued 1988.

Perf.: \$300 Exc.: \$250 VGood: \$200

### LORCIN L-9MM

Semi-automatic; single action; 9mm Para.; 10-shot magazine; 4 1/2" barrel; 7 1/2" overall length; weighs 31 oz.; grooved black composition grips; fixed sights

with three-dot system; matte black finish; hooked triggerguard; grip safety. Made in U.S. by Lorcin Engineering. Introduced 1994; still in production.

New: \$125 Perf.: \$110 Exc.: \$90

### LORCIN L-22

Semi-automatic; single action; 22 LR; 9-shot magazine; 2 1/2" barrel; 5 1/4" overall length; weighs 16 oz.; black combat, or pink or pearl grips; fixed three-dot sight system; chrome or black Teflon finish. From Lorcin Engineering. Introduced 1989; still in production.

Perf.: \$65 Exc.: \$50 VGood: \$40

Pink grips

Perf.: \$50 Exc.: \$40 VGood: \$30

### LORCIN L-25

Semi-automatic; single action; 25 ACP; 7-shot magazine; 2 5/16" barrel; 4 5/8" overall length; weighs 14 1/2 oz.; fixed sights; smooth composition stocks; black/gold, chrome/satin chrome, black finish. Introduced 1989; still in production.

Perf.: \$50 Exc.: \$40 VGood: \$30

### LORCIN L-32

Semi-automatic; single action; 32 ACP; 7-shot magazine; 3 1/2" barrel; 6 5/8" overall length; weighs 23 oz.; fixed sights; grooved composition grips; black Teflon or chrome finish with black grips. Made in U.S. by Lorcin Engineering. Introduced 1992; still in production.

New: \$70 Perf.: \$65 Exc.: \$50

### LORCIN L-380

Semi-automatic; single action; 380 ACP; 7-shot magazine; 3 1/2" barrel; 6 5/8" overall length; weighs 23 oz.; fixed sights; grooved composition grips; black Teflon or chrome finish with black grips. Made in U.S.

by Lorcin Engineering. Introduced 1992; still in production.

New: \$85 Perf.: \$65 Exc.: \$50

### LORCIN LH-380

Semi-automatic; 380 ACP; 10-shot magazine; 4 1/2" barrel; 7 1/2" overall length; weighs 31 oz.; grooved black composition grips; fixed sights with three-dot system; matte black finish; hooked triggerguard; grip safety. Made in U.S. by Lorcin Engineering. Introduced 1994; still in production.

New: \$125 Perf.: \$100 Exc.: \$75

### LORCIN LT-25

Semi-automatic; single action; 25 ACP; 7-shot magazine; 2 1/3" barrel; 4 2/3" overall length; weighs 14 1/2 oz.; fixed sights; smooth composition grips; available in chrome, black Teflon or camouflage. Made in U.S. by Lorcin Engineering. Introduced 1989; still in production.

New: \$60 Perf.: \$50 Exc.: \$40

### LUGER

The Luger pistol was redesigned from the 1893 Borchardt pistol by George Luger and came on the market in 1900. Its use by the German military as well as many other governments and its many variations have made it the most popular semi-automatic pistol for collectors, and it is very well regarded by shooters as well. Lugers have been widely collected and very thoroughly researched, and there are many other rare variations in addition to those listed below. To identify a Luger that does not seem to agree with those described, refer to one of the major Luger references such as "Lugers At Random" by Charles Kenyon.

Joe Schroeder

### LORCIN MODEL 1900 COMMERCIAL

Semi-automatic; 7.65mm Para.; 7-shot magazine; 4 3/4" barrel; 9 1/4" overall length; fixed sights; toggle-joint action; grip safety; checkered wood grips; blued finish. Toggle marked in script "DWM" for Deutsche Waffen und Munitionsfabrik. Distinguished by dished toggle knobs with a lock, recessed breech-block.

Exc.: \$3250 VGood: \$2750 Good: \$2000

### Luger Model 1900 Swiss

Same specs as Model 1900 Commercial except Swiss cross on chamber.

Exc.: \$3750 VGood: \$2750 Good: \$2000



# HANDGUNS

## Rossi

**Model 89 Stainless**  
**Model 94**  
**Model 511 Sportsman**  
**Model 515**  
**Model 518**  
**Model 720**  
**Model 720C**  
**Model 851**  
**877 Revolver**  
**Model 941**  
**Model 951**  
**Model 971**  
**Model 971 Comp Gun**  
**Model 971 Stainless**  
**Model 971 VRC Revolver**



Rossi Model 511 Sportsman



Rossi Model 68



Rossi Lady Rossi



Rossi Model 518



Rossi Model 951



Rossi Model 720C



Rossi Model 851



Rossi Model 971 Comp Gun

### ROSSI MODEL 89 STAINLESS

Revolver; double action; 32 S&W; 6-shot; 3" barrel; 8 3/4" overall length; weighs 21 oz.; ramp front sight, drift-adjustable square notch rear; checkered wood or rubber stocks; stainless steel; matte finish. Introduced 1985; discontinued 1986; reintroduced 1989; no longer imported.

**Exc.:** \$160 **VGGood:** \$150 **Good:** \$125

### ROSSI MODEL 94

Revolver; double action; 38 Spl.; 6-shot; 3", 4" barrel; 27 1/2 oz.; ramp front sight; adjustable rear; checkered wood stocks; blued finish. Introduced 1985; discontinued 1988.

**Exc.:** \$175 **VGGood:** \$150 **Good:** \$135

### ROSSI MODEL 511 SPORTSMAN

Revolver; double action; 22 LR; 6-shot; 4" barrel; 9" overall length; weighs 30 oz.; adjustable square-notch rear sight, orange-insert ramp front; checkered wood stocks; heavy barrel; integral sight rib; shrouded ejector rod; stainless steel construction. Made in Brazil. Introduced 1986; discontinued 1990.

**Exc.:** \$150 **VGGood:** \$135 **Good:** \$125

### ROSSI MODEL 515

Revolver; double action; 22 WMR; 6-shot cylinder; 4" barrel; 9" overall length; weighs 30 oz.; checkered wood and finger-groove wrap-around rubber grips; blade front sight with red insert, fully-adjustable rear; small frame; stainless steel construction; solid integral barrel rib. Imported from Brazil by Interarms. Introduced 1994; still imported.

**New:** \$200 **Perf.:** \$175 **Exc.:** \$150

### ROSSI MODEL 518

Revolver; double action; 22 LR; 6-shot cylinder; 4" barrel; 9" overall length; weighs 30 oz.; checkered wood and finger-groove wrap-around rubber grips; blade front sight with red insert, fully-adjustable rear; small frame; stainless steel construction; solid integral barrel rib. Imported from Brazil by Interarms. Introduced 1994; no longer imported.

**New:** \$200 **Perf.:** \$185 **Exc.:** \$160

### ROSSI MODEL 720

Revolver; double action; 44 Spl.; 5-shot cylinder; 3" barrel; 8" overall length; weighs 27 1/2 oz.; checkered rubber, combat-style grips; red insert front sight on ramp, fully-adjustable rear; all stainless steel construction; solid barrel rib; full ejector rod shroud. Imported from Brazil by Interarms. Introduced 1992.

**New:** \$225 **Perf.:** \$175 **Exc.:** \$150

### Rossi Model 720C

Same specs as the Model 720 except spurless hammer; double-action only. Imported from Brazil by Interarms. Introduced 1992; no longer imported.

**New:** \$200 **Perf.:** \$165 **Exc.:** \$135

### ROSSI MODEL 851

Revolver; double action; 38 Spl.; 6-shot; 3", 4" barrel; 8" overall length (3" barrel); weighs 27 1/2 oz.; red-insert blade front sight, windage-adjustable rear; checkered Brazilian hardwood grips; medium-size frame; stainless steel construction; vent rib. Introduced 1991; no longer imported.

**New:** \$200 **Perf.:** \$175 **Exc.:** \$135

### ROSSI MODEL 877 REVOLVER

Caliber: 357 Mag., 6-shot cylinder. Barrel: 2". Weight: 26 oz. Length: NA. Stocks: Stippled synthetic. Sights: Blade front, fixed groove rear. Features: Stainless steel construction; fully enclosed ejector rod. Introduced 1996. no longer imported.

**Perf.:** \$200 **Exc.:** \$165 **VGGood:** \$140

### ROSSI MODEL 941

Revolver; double action; 38 Spl.; 6-shot; 4" solid rib barrel; 9" overall length; weighs 30 oz.; colored insert

front sight, adjustable rear; checkered hardwood combat stocks; shrouded ejector rod; blued finish. Made in Brazil. Introduced 1985; discontinued 1990.

**Exc.:** \$175 **VGGood:** \$150 **Good:** \$125

### ROSSI MODEL 951

Revolver; double action; 38 Spl.; 6-shot; 4" vent-rib barrel; 9" overall length; weighs 30 oz.; colored insert front sight, adjustable rear; checkered hardwood combat stocks; shrouded ejector rod; blued finish. Made in Brazil. Introduced 1985; discontinued 1990.

**Exc.:** \$175 **VGGood:** \$150 **Good:** \$125

### ROSSI MODEL 971

Revolver; double action; 357 Mag.; 6-shot; 2 1/2", 4", 6" heavy barrel; 9" overall length; weighs 36 oz.; blade front sight, fully-adjustable rear; checkered Brazilian hardwood grips; matted sight rib; target trigger; wide checkered hammer spur; full-length ejector rod shroud; blued (4" only) or stainless finish. Made in Brazil. Introduced 1988; no longer imported.

**New:** \$200 **Perf.:** \$175 **Exc.:** \$150

### Rossi Model 971 Comp Gun

Same specs as Model 971 except stainless finish; 3 1/4" barrel with integral compensator; overall length 9"; weighs 32 oz.; red insert front sight, fully-adjustable rear; checkered, contoured rubber grips. Imported from Brazil by Interarms. Introduced 1993; no longer imported

**New:** \$225 **Perf.:** \$200 **Exc.:** \$175

### Rossi Model 971 Stainless

Same general specs as Model 971 except 2 1/2", 4", 6" barrel; rubber grips; stainless steel construction. Introduced 1989; no longer imported.

**New:** \$225 **Perf.:** \$200 **Exc.:** \$175

### Rossi Model 971 VRC Revolver

Similar to the Model 971 except has Rossi's 8-port Vented Rib Compensator; checkered finger-groove rubber grips; stainless steel construction. Available with 2.5", 4", 6" barrel; weighs 30 oz. with 2-5/8" barrel. Introduced 1996. No longer imported.

**Perf.:** \$275 **Exc.:** \$235 **VGGood:** \$200

# HANDGUNS

## SIG Sauer

- P220 "American"
- P225
- P226
- P228
- P229
- P229 S Auto Pistol
- P230
- P230 SL Stainless
- P232
- P239 Pistol



SIG Sauer P232



SIG Sauer P220 "American"



SIG Sauer P226



SIG Sauer P228



SIG Sauer P230

### SIG SAUER P220 "AMERICAN"

Semi-automatic; double action; 38 Super, 45 ACP; 9-shot (38 Super), 7-shot (45 ACP) magazine; 4 3/8" barrel; 7 3/4" overall length; weighs 28 1/4 oz. (9mm); checkered black plastic grips; blade front sight, drift-adjustable rear; squared combat-type trigger guard; side-button magazine release. Im ported from Germany by SIGARMS, Inc. Still imported but only in 45 ACP.

<b>New:</b> \$650	<b>Perf.:</b> \$600	<b>Exc.:</b> \$500
With Siglite night sights		
<b>New:</b> \$750	<b>Perf.:</b> \$700	<b>Exc.:</b> \$575
With K-Kote finish		
<b>New:</b> \$675	<b>Perf.:</b> \$625	<b>Exc.:</b> \$525
With K-Kote finish, Siglite night sights		
<b>New:</b> \$800	<b>Perf.:</b> \$750	<b>Exc.:</b> \$600

### SIG SAUER P225

Semi-automatic; double action, DA-only; 9mm Para.; 8-shot; 3 7/8" barrel; 7 3/32" overall length; weighs 26 oz.; blade-type front sight, windage-adjustable rear; checkered black plastic stocks; squared combat-type trigger guard; shorter, lighter version of P220; blued finish. Made in Germany. Introduced 1985, dropped 1998.

<b>New:</b> \$600	<b>Perf.:</b> \$550	<b>Exc.:</b> \$450
K-Kote finish		
<b>New:</b> \$650	<b>Perf.:</b> \$600	<b>Exc.:</b> \$500
Nickel finish		
<b>New:</b> \$650	<b>Perf.:</b> \$600	<b>Exc.:</b> \$500
Siglite night sights		
<b>New:</b> \$700	<b>Perf.:</b> \$650	<b>Exc.:</b> \$525

### SIG SAUER P226

Semi-automatic; double action, DA-only; 9mm Para.; 15-, 20-shot; 4 3/8" barrel; weighs 26 1/2 oz.; high contrast sights; black plastic checkered stocks; blued finish. Made in Germany. Introduced 1983; still imported.

<b>New:</b> \$700	<b>Perf.:</b> \$600	<b>Exc.:</b> \$500
K-Kote finish		
<b>New:</b> \$750	<b>Perf.:</b> \$650	<b>Exc.:</b> \$550
Nickel finish		
<b>New:</b> \$750	<b>Perf.:</b> \$650	<b>Exc.:</b> \$550
Siglite night sights		
<b>New:</b> \$800	<b>Perf.:</b> \$700	<b>Exc.:</b> \$575

### SIG SAUER P228

Semi-automatic; double action, DA-only; 9mm Para.; 10-shot; 3 7/8" barrel; 7" overall length; weighs 29 oz.;

three-dot sights; black plastic grips; blued finish. Made in Germany. Introduced 1989; dropped 1997.

<b>New:</b> \$650	<b>Perf.:</b> \$550	<b>Exc.:</b> \$475
K-Kote finish		
<b>New:</b> \$700	<b>Perf.:</b> \$600	<b>Exc.:</b> \$500
Nickel finish		
<b>New:</b> \$700	<b>Perf.:</b> \$600	<b>Exc.:</b> \$500
Siglite night sights		
<b>New:</b> \$750	<b>Perf.:</b> \$650	<b>Exc.:</b> \$550

### SIG SAUER P229

Semi-automatic; double action, DA-only; 9mm Para., 40 S&W, 357 SIG; 12-shot; 3 7/8" barrel; 7" overall length; 30 1/2 oz.; three-dot sights; checkered black plastic grips; aluminum alloy frame; blued slide. Made in Germany. Introduced 1991; still produced.

<b>New:</b> \$700	<b>Perf.:</b> \$600	<b>Exc.:</b> \$500
Siglite night sights		
<b>New:</b> \$800	<b>Perf.:</b> \$700	<b>Exc.:</b> \$575
Nickel		
<b>New:</b> \$850	<b>Perf.:</b> \$750	<b>Exc.:</b> \$650

### SIG Sauer P229 S Auto Pistol

Similar to the P229 except available in 357 SIG only; 4.8" heavy barrel; 8.6" overall length; weighs 40.6 oz.; vented compensator; adjustable target sights; rubber grips; extended slide latch and magazine release. Made of stainless steel. Introduced 1998.

<b>New:</b> \$1100	<b>Perf.:</b> \$950	<b>Exc.:</b> \$750
--------------------	---------------------	--------------------

### SIG SAUER P230

Semi-automatic; double action; 22 LR, 32 ACP, 380 ACP, 9mm Ultra; 10-shot (22 LR), 8-shot (32 ACP), 7-shot (380 ACP, 9mm); 3 3/4" barrel; 6 1/2" overall length; weighs 16 oz.; fixed sights; checkered black plastic stocks; blued finish. Introduced 1977; dropped 1996. Manufactured in Germany.

<b>New:</b> \$400	<b>Perf.:</b> \$350	<b>Exc.:</b> \$300
-------------------	---------------------	--------------------

### SIG Sauer P230 SL Stainless

Same specs as P230 except stainless steel; 22 oz.

<b>New:</b> \$450	<b>Perf.:</b> \$400	<b>Exc.:</b> \$350
-------------------	---------------------	--------------------

### SIG SAUER P232

Semi-automatic; double action. Improved version of P230; 32 ACP, 380 ACP, 8-shot (32 ACP), 7-shot (380 ACP); 3 3/4" barrel; 6 1/2" overall length; weighs 16 oz.; fixed sights; checkered black plastic stocks; blued finish. Introduced 1997. Imported from Germany by SIGARMS, Inc.

<b>New:</b> \$500	<b>Perf.:</b> \$600	<b>Exc.:</b> \$500
-------------------	---------------------	--------------------

### SIG SAUER P239

Semi-automatic; double action; 9mm Para., 8-shot, 357 SIG, 40 S&W, 7-shot magazine. Barrel: 3.6" Weight: 25.2 oz. Length: 6.6" overall. Stocks: Checkered black composite. Sights: Blade front, rear adjustable for windage. Optional Siglite night sights. Features: SA/DA or DAO; blackened stainless steel slide, aluminum alloy frame. Introduced 1996.

<b>New:</b> \$600	<b>Perf.:</b> \$500	<b>Exc.:</b> \$450
-------------------	---------------------	--------------------

With Siglite night sights

<b>New:</b> \$675	<b>Perf.:</b> \$550	<b>Exc.:</b> \$500
-------------------	---------------------	--------------------

### SMITH & WESSON

The section on Smith & Wesson handguns has been reorganized to make it easier to use and understand. First, it has been divided into revolvers and semi-automatics with revolvers listed first.

Second, these two major areas are delineated further with revolvers divided into four distinct groups: Early Models, Small (I and J) Frames, Medium (K and L) Frames, Large (N) Frames; and semi-automatics divided into five groups: Pre-WWII, Post-WWII, 2nd Generation, 3rd Generation and Rimfire Target.

Today's Smith & Wessons all bear a model number and serial number. However, prior to 1958, S&W handguns bore only a serial number along with the specific name of that model, e.g. 38 Military & Police. In 1958, the factory began using a model numbering system. On revolvers, the model designation is stamped in the yoke cut in the frame and covered by the cylinder arm when the cylinder is in the closed position. The official serial number can be found on the butt of the gun. For revolvers factory-issued with target stocks that cover the butt, the serial number is



# HANDGUNS

## Smith & Wesson Revolvers

1960 22/32 Kit Gun M.R.F. (Model 51)  
 1977 22/32 Kit Gun M.R.F. (Model 63)  
 Airweight Kit Gun (Model 43)  
 Bodyguard (Model 49)  
 Bodyguard Airweight (Model 38)  
 Centennial (Model 40)  
 Centennial (Model 640)  
 Centennial Airweight (Model 42)  
 Centennial Airweight (Model 442)  
 Centennial Airweight (Model 642)  
 Chief's Special (Model 36)



Smith & Wesson Bodyguard (Model 649)



Smith & Wesson Centennial (Model 40)



Smith & Wesson 1977 22/32 Kit Gun M.R.F. (Model 63)



Smith & Wesson Centennial (Model 640)

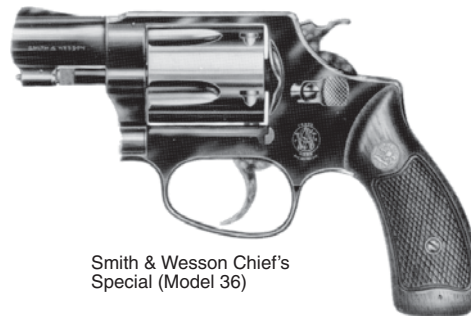

Smith & Wesson Chief's Special (Model 36)

also stamped on the frame in the area under the yoke. Serial numbers that begin with a letter indicate post-World War II manufacture. The new triple-alpha/four-numeric system began in 1980. Caution:

1. There is also a number stamped on the yoke which is called the work number. There is no relationship between this number and the serial number.

2. Handguns are classified by basic model numbers. The number following the model number is called the dash number and is necessary only when ordering parts.

On semi-automatics, the serial number can be found on the left side of the frame along with the model designation.

Roy Jinks

### SMITH & WESSON 1960 22/32 KIT GUN M.R.F. (MODEL 51)

Revolver; 22 WMR; 3 1/2" barrel; 8" overall length; weighs 24 oz.; all steel frame and cylinder; fixed 1/10" serrated front ramp, micro-click adjustable rear; checkered walnut, round or square-butt stocks; blue or nickel finish. Introduced 1960; dropped 1974.

Exc.: \$325 VGood: \$275 Good: \$225

Nickel finish

Exc.: \$350 VGood: \$300 Good: \$250

### SMITH & WESSON 1977 22/32 Kit Gun M.R.F. (MODEL 63)

Revolver; 22 LR; 6-shot; 2", 4" barrel; 8" overall length (4" barrel); weighs 24 1/4 oz.; stainless steel construction; fixed 1/10" serrated front ramp sight, micro-click adjustable rear; round butt soft rubber or checkered walnut square-butt stocks with medallion; satin finish. Introduced 1977; still in production.

New: \$375 Perf.: \$325 Exc.: \$250

### SMITH & WESSON AIRWEIGHT KIT GUN (MODEL 43)

Revolver; 22 LR; 3 1/2" barrel; 8" overall length; weighs 14 1/4 oz.; alloy aluminum frame and cylinder; fixed 1/10" serrated front ramp, micro-click adjustable rear; checkered walnut, round or square-butt stocks; blue or nickel finish. Introduced 1955; dropped 1974.

Exc.: \$350 VGood: \$300 Good: \$250

### SMITH & WESSON BODYGUARD (MODEL 49)

Revolver; double action; 38 Spl.; 5-shot; 2" barrel; 6 5/16" overall length; steel construction; weighs 20 1/2 oz.; fixed 1/10" serrated front ramp, square notch rear; blue or nickel finish; features shrouded hammer that can be cocked manually for single-action firing. Introduced 1955; dropped 1996.

Perf.: \$250 Exc.: \$200 VGood: \$175

### SMITH & WESSON BODYGUARD (MODEL 649)

Revolver; double action; 38 Spl.; 5-shot; 2" barrel; 6 5/16" overall length; weighs 20 1/2 oz.; stainless steel construction; fixed 1/10" serrated front ramp, square notch rear; satin finish; features shrouded hammer that can be cocked manually for single-action firing. Introduced 1955; still in production.

Perf.: \$375 Exc.: \$325 VGood: \$250

### SMITH & WESSON BODYGUARD AIRWEIGHT (MODEL 38)

Revolver; double action; 38 Spl.; 5-shot; 2" barrel; 6 5/16" overall length; weighs 14 1/2 oz.; fixed 1/10" serrated front ramp, square notch rear; blue or nickel finish; features shrouded hammer that can be cocked manually for single-action firing. Introduced 1955; dropped 1998.

Perf.: \$350 Exc.: \$250 VGood: \$200

### SMITH & WESSON CENTENNIAL (MODEL 40)

Revolver; double action; 38 Spl.; 5-shot; 2" barrel; 6 1/2" overall length; weighs 19 oz.; concealed hammer; fixed 1/10" serrated front ramp, square notch rear. Swing-out version of earlier top-break design with grip safety. Introduced 1953; dropped 1974. Collector value.

Exc.: \$400 VGood: \$350 Good: \$275

### SMITH & WESSON CENTENNIAL (MODEL 640)

Revolver; double action; 38 Spl.; 5-shot; 2", 3" barrel; 6 5/16" overall length; weighs 20 oz.; serrated ramp front, fixed notch rear sight; Goncalo Alves round-butt grips; stainless steel version of the Model 40 sans grip safety; concealed hammer; smoothed edges. Introduced 1990; still in production.

New: \$375 Perf.: \$325 Exc.: \$275

### SMITH & WESSON CENTENNIAL (MODEL 940)

Revolver; double action; 9mm Para.; 5-shot; 2", 3" barrel; 6 5/16" overall length; weighs 20 oz.; serrated ramp front, fixed notch rear sight; rubber grips; stainless steel version of the Model 40 sans grip safety; concealed hammer; smoothed edges. Introduced 1990; dropped 1998.

New: \$375 Perf.: \$325 Exc.: \$275

### SMITH & WESSON CENTENNIAL AIRWEIGHT (MODEL 42)

Revolver; double action; 38 Spl.; 5-shot; 2" barrel; 6 1/2" overall length; concealed hammer; aluminum alloy frame and cylinder; fixed 1/10" serrated front ramp, square notch rear. Lightweight version of Model 40. Introduced 1953; dropped 1974. Collector value.

Blue Exc.: \$400 VGood: \$350 Good: \$250

Nickel

Exc.: \$950 VGood: \$750 Good: \$450

### SMITH & WESSON CENTENNIAL AIRWEIGHT (MODEL 442)

Revolver; double action; 38 Spl.; 5-shot cylinder; 2" barrel; weighs 15 3/4 oz.; 6 5/8" overall length; Uncle Mike's Custom Grade Santoprene grips; serrated ramp front sight, fixed notch rear; alloy frame; carbon steel barrel and cylinder; concealed hammer. Made in U.S. by Smith & Wesson. Introduced 1993; still produced.

New: \$350 Perf.: \$300 Exc.: \$250

Nickel finish

New: \$375 Perf.: \$325 Exc.: \$275

### SMITH & WESSON CENTENNIAL AIRWEIGHT (MODEL 642)

Revolver; double action; 38 Spl.; 5-shot; 2" carbon steel barrel; 6 5/16" overall length; anodized alloy frame; weighs 16 oz.; serrated ramp front, fixed notch rear sight; Uncle Mike's Custom Grade Santoprene grips; same as the Model 40 sans grip safety; concealed hammer; smoothed edges. Introduced 1990; still in production.

Perf.: \$400 Exc.: \$350 VGood: \$250

### SMITH & WESSON CHIEF'S SPECIAL (MODEL 36)

Revolver; double action; 38 Spl.; 5-shot; 2", 3" barrel; 7 3/8" overall length (3" barrel); weighs 21 1/2 oz.; fixed 1/10" serrated front ramp, square notch rear; all steel frame and cylinder; checkered round butt soft rubber grips most common; square-butt available; blue or nickel finish. Dropped 1999.

New: \$275 Perf.: \$225 Exc.: \$175

# HANDGUNS

## Smith & Wesson

Chief's Special Airweight (Model 37)  
 Model 637 Airweight Revolver  
 Chief's Special Stainless (Model 60)  
 Model 60 357 Magnum Chiefs Special  
 Ladysmith (Model 36-LS)  
 Ladysmith (Model 60-LS)  
 Model 60 3 $\frac{1}{2}$  Full Lug  
 Model 651  
 Target Model 1953 (Model 35)  
 Terrier (Model 32)  
 K and L Medium Frame Revolvers  
 32-20 Hand Ejector  
 38 Military & Police



Smith & Wesson Centennial Airweight (Model 442)



Smith & Wesson Chief's Special Airweight (Model 37)



Smith & Wesson Ladysmith (Model 60 L-S)

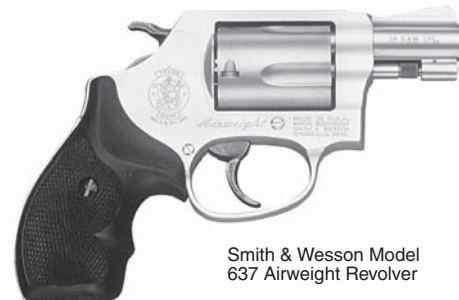

Smith & Wesson Model 637 Airweight Revolver



Smith & Wesson Target Model 1953 (Model 35)



Smith & Wesson Model 60 357 Mangum Chief's Special



Smith & Wesson Model 651

### SMITH & WESSON CHIEF'S SPECIAL AIRWEIGHT (MODEL 37)

Revolver; double action; 38 Spl.; 5-shot; 2" barrel; 6 1/2" overall length; weighs 19 1/2 oz.; lightweight version of Model 36, incorporating aluminum alloy frame; weighs 14 1/2 oz.; fixed 1/10" serrated front ramp, square notch rear; all steel frame and cylinder; checkered round butt grips most common; square-butt available; blue or nickel finish. Still in production.

New: \$350 Perf.: \$275 Exc.: \$225

### Smith & Wesson Model 637 Airweight Revolver

Similar to the Model 37 Airweight except has alloy frame, stainless steel barrel, cylinder and yoke; rated for 38 Spec. +P; Uncle Mike's Boot Grip. Weighs 15 oz. Introduced 1996.

New: \$375 Perf.: \$300 Exc.: \$225

### SMITH & WESSON CHIEF'S SPECIAL STAINLESS (MODEL 60)

Revolver; double action; 38 Spl.; 5-shot; 2" barrel; 6 1/2" overall length; weighs 19 oz.; stainless steel construction; fixed 1/10" serrated front ramp, square notch rear; checkered walnut round butt grips. Dropped 1996.

New: \$300 Perf.: \$250 Exc.: \$225

### Smith & Wesson Model 60 357 Magnum Chiefs Special

Similar to the Model 60 in 38 Special except is 357 Magnum; 2-1/8" or 3" barrel. Weighs 24 oz.; 7-1/2" overall length (3" barrel). Has Uncle Mike's Combat grips.

New: \$400 Perf.: \$350 Exc.: \$275

### SMITH & WESSON LADYSMITH (MODEL 36-LS)

Revolver; double action; 38 Spl.; 5-shot; 2" barrel; 6 5/16" overall length; weighs 20 oz.; carbon steel construction; serrated front ramp, square notch rear; rosewood laminate grips; comes in fitted carry/storage case; blue finish. Introduced 1989; still in production.

New: \$350 Perf.: \$300 Exc.: \$225

### SMITH & WESSON LADYSMITH (MODEL 60-LS)

Revolver; double action; 38 Spl.; 5-shot; 2" barrel; 6 5/16" overall length; weighs 20 oz.; stainless steel construction; serrated front ramp, square notch rear; rosewood laminate grips; stainless satin finish. Introduced 1989; still in production.

New: \$350 Perf.: \$300 Exc.: \$250

### SMITH & WESSON MODEL 60 3" FULL LUG

Revolver; double action; 38 Spl.; 5-shot; 3" full lug barrel; 7 1/2" overall length; weighs 24 1/2 oz.; stainless steel construction; fixed pinned black ramp front sight, adjustable black blade rear; rubber combat grips. Introduced 1991; still in production.

New: \$350 Perf.: \$300 Exc.: \$250

### SMITH & WESSON MODEL 651

Revolver; double action; 22 WMR; 6-shot cylinder; 4" heavy barrel; 8 11/16" overall length; weighs 24 1/2 oz.; stainless steel construction; ramp front, adjustable micrometer-click rear; semi-target hammer; combat trigger; soft rubber or checkered walnut square-butt stocks with medallion; satin finish. Introduced 1983; dropped 1998.

Exc.: \$300 VGood: \$250 Good: \$150

### SMITH & WESSON TARGET MODEL 1953 (MODEL 35)

Revolver; 22 LR; 6-shot; 6" barrel; 10 1/2" overall length; weighs 25 oz.; ribbed barrel; micrometer rear sight; Magna-type stocks; flattened cylinder latch; blue finish. A redesign of the 22/32 Target model. Introduced 1953; dropped 1974.

Exc.: \$300 VGood: \$200 Good: \$175

### SMITH & WESSON TERRIER (MODEL 32)

Revolver; 38 S&W, 38 Colt New Police; 5-shot; 2" barrel; 6 1/4" overall length; weighs 17 oz.; fixed sights with 1/10" serrated ramp front, square notch rear;

round butt checkered walnut stocks with medallion; blue or nickel finish. Introduced 1936; dropped 1974.

Exc.: \$250 VGood: \$175 Good: \$125

### K AND L MEDIUM FRAME REVOLVERS

Smith & Wesson's original medium-frame revolver was the "K" frame introduced in 1899. In 1980, S&W offered an improved medium frame revolver for the 357 Magnum cartridge and this new frame was called the "L" frame.

### SMITH & WESSON 32-20 HAND EJECTOR

Revolver; 32 Winchester; 6-shot; 4", 5", 6", 6 1/2" barrels; fixed or adjustable sights (rare); hard black rubber round or checkered walnut square-butt grips; caliber marking on early models, 32 Winchester; late models, 32 W.C.F., marked 32/20.

Exc.: \$400 VGood: \$325 Good: \$175

### SMITH & WESSON 38 MILITARY & POLICE

Revolver; double action; 38 Spl.; 6-shot; 4", 5", 6", 6 1/2" barrels; hard rubber round butt (early models) or checkered walnut square-butt grips; blue or nickel finish. The first S&W K-frame was the 38 Hand Ejector which later became known as the 38 Military & Police. This model was introduced in 1899 and has been in continuous production. During the last 96 years, S&W has produced over 5 million of these revolvers, resulting in numerous variations which affect values only slightly. The most collectable of these, the 38 Hand Ejector First Model, can be easily recognized by the lack of a locking lug located on the underside of the barrel and the serial number 1 through 20,975. Between 1899 and 1940 this model was available with both fixed sights and an adjustable target sight. The target model, referred to as the 38 Military and Police Target Model, brings a premium price and was the predecessor to all K-frame target models.

38 Hand Ejector First Model  
 Exc.: \$450 VGood: \$300 Good: \$150  
 Standard models  
 Exc.: \$300 VGood: \$225 Good: \$135



# HANDGUNS

## Smith & Wesson Semi-Automatic Pistols

Model 459  
Model 469  
Model 539  
Model 559  
Model 639  
Model 645  
Model 659  
Model 669  
Model 745

Third Generation Models  
(1988-1995)  
Model 356 TSW Limited  
Model 356 TSW Compact  
Model 410 DA  
Model 411



Smith & Wesson  
Model 469



Smith & Wesson  
Model 669



Smith & Wesson  
Model 645



Smith & Wesson  
Model 910



Smith & Wesson  
Model 745



Smith & Wesson  
Model 410 DA

### SMITH & WESSON MODEL 459

Semi-automatic; double-action; 9mm Para.; 14-shot magazine; 4" barrel; 7 7/16" overall length; weighs 27 1/2 oz. sans magazine; has same general specs as Model 439, except for increased magazine capacity, straighter, longer grip frame; blued or nickel finish. Introduced 1980; dropped 1989.

Blue finish

Exc.: \$350 VGood: \$300 Good: \$250

Nickel finish

Exc.: \$375 VGood: \$325 Good: \$275

### SMITH & WESSON MODEL 469

Semi-automatic; 9mm Para.; 3 1/2" barrel; 12-shot magazine; accepts 14-shot 459 magazine; 6 7/8" overall length; weighs 26 oz.; cut-down version of Model 459; cross-hatching on front of trigger guard, backstrap; plastic pebble-grain grips; curved finger-extension magazine; bobbed hammer; sand-blasted blued finish. Introduced 1983; dropped 1988.

Exc.: \$300 VGood: \$250 Good: \$225

### SMITH & WESSON MODEL 539

Semi-automatic; double action; 9mm Para.; 8-shot magazine; 4" barrel; 7 7/16" overall length; weighs 36 oz.; carbon steel construction; trigger-actuated firing pin lock; magazine disconnect; 1/8" serrated ramp front, windage-adjustable square notch rear and protective shield on both sides of blade; checkered high-impact moulded nylon; bright blue or nickel finish. Approximately 10,000 manufactured. Introduced 1981; dropped 1984.

Exc.: \$400 VGood: \$350 Good: \$300

### SMITH & WESSON MODEL 559

Semi-automatic; double action; 9mm Para.; 14-shot magazine; 4" barrel; 7 7/16" overall length; weighs 40 oz. sans magazine; has same general specs as Model 459, except carbon steel construction; blue or nickel finish. Approximately 10,000 manufactured. Introduced 1981; dropped 1984.

Exc.: \$450 VGood: \$400 Good: \$350

### SMITH & WESSON MODEL 639

Semi-automatic; double action; 9mm Para.; 8-shot magazine; 4" barrel; 7 7/16" overall length; weighs 27 1/2 oz. sans magazine; stainless steel construction; trigger-actuated firing pin lock; magazine disconnect; 1/8" serrated ramp front, windage-adjustable square notch rear with protective shield on both sides of blade; checkered high-impact moulded nylon; bright blue or nickel finish. Introduced 1981; dropped 1988.

Exc.: \$350 VGood: \$300 Good: \$250

### SMITH & WESSON MODEL 645

Semi-automatic; double action; 45 ACP; 8-shot magazine; 5" barrel; 8 3/4" overall length; weighs 37 5/8 oz.; red ramp front sight, drift-adjustable rear; checkered nylon stocks; stainless steel construction; cross-hatch knurling on recurved front trigger guard, backstrap; beveled magazine well. Introduced 1985; dropped 1988.

Exc.: \$450 VGood: \$400 Good: \$350

### SMITH & WESSON MODEL 659

Semi-automatic; double action; 9mm Para.; 14-shot magazine; 4" barrel; 7 7/16" overall length; weighs 27 1/2 oz. sans magazine; has same general specs as Model 439, except stainless steel construction. Introduced 1981; dropped 1988.

Exc.: \$350 VGood: \$300 Good: \$225

### SMITH & WESSON MODEL 669

Semi-automatic; 9mm Para.; 3 1/2" barrel; 12-shot magazine; accepts 14-shot 459 magazine; 6 7/8" overall length; weighs 26 oz.; same specs as Model 469 except slide and barrel manufactured of stainless steel; aluminum alloy frame finished in natural finish. Introduced 1985; dropped 1988.

Exc.: \$350 VGood: \$300 Good: \$250

### SMITH & WESSON MODEL 745

Semi-automatic; 45 ACP; 8-shot magazine; 5" barrel; 8 5/8" overall length; weighs 38 3/4 oz.; fixed Novak rear sight, serrated ramp front; blued slide, trigger, hammer, sights. Marketed with two magazines. Introduced 1987; dropped 1990.

Exc.: \$450 VGood: \$400 Good: \$350

### THIRD GENERATION MODELS (1988-1995)

#### SMITH & WESSON MODEL 356 TSW LIMITED

Semi-automatic; single action; 356 TSW; 15-shot magazine; 5" barrel; weighs 44 oz.; 8 1/2" overall length; checkered black composition grips; blade front sight drift adjustable for windage, fully-adjustable Bo-Mar rear; stainless steel frame and slide; hand-fitted titaniumcoated stainless steel bushing; match grade barrel; extended magazine well and oversize release; magazine pads; extended safety. Checkered front strap. Made in U.S. by Smith & Wesson; available through Lew Horton Dist. Introduced 1993; no longer in production.

Exc.: \$1200 VGood: \$850 Good: \$750

#### Smith & Wesson Model 356 TSW Compact

Same specs as the 356 TSW Limited except has 3 1/2" barrel; 12-shot magazine; Novak LoMount combat sights; 7" overall length; weighs 37 oz. Made in U.S. by Smith & Wesson; available from Lew Horton Dist. Introduced 1993; no longer in production.

Exc.: \$850 VGood: \$725 Good: \$550

#### SMITH & WESSON MODEL 410 DA

Semi-automatic; double action; 40 S&W, 10-shot magazine. Barrel: 4". Weight: 28.5 oz. Length: 7.5 oz. Stocks: One-piece Xenoy, wrap-around with straight backstrap. Sights: Post front, fixed rear; three-dot system. Features: Aluminum alloy frame; blued carbon steel slide; traditional double action with left-side slide-mounted decocking lever. Introduced 1996.

New: \$425 Perf.: \$375 Exc.: \$300

#### SMITH & WESSON MODEL 411

Semi-automatic; double action; 40 S&W; 10-shot magazine; 4" barrel; weighs 28 oz.; 7 3/8" overall length; one-piece Xenoy wrap-around grips with straight backstrap; post front sight with white dot, fixed two-dot rear; alloy frame, blue carbon steel slide; slide-mounted decocking lever. Made in U.S. by Smith & Wesson. Introduced 1994; still produced.

New: \$450 Perf.: \$400 Exc.: \$325

# HANDGUNS

## Smith & Wesson Semi-Automatic Pistols

- Model 908
- Model 909
- Model 910
- Model 915
- Model 1006
- Model 1026
- Model 1046
- Model 1066
- Model 1066-NS
- Model 1076
- Model 1086
- Model 3904
- Model 3906
- Model 3913



Smith & Wesson  
Model 908

### SMITH & WESSON MODEL 908

Caliber: 9mm Para., 8-shot magazine. Barrel: 3-1/2". Weight: 26 oz. Length: 6-13/16". Stocks: One-piece Xenoy, wrap-around with straight backstrap. Sights: Post front, fixed rear, three-dot system. Features: Aluminum alloy frame, matte blue carbon steel slide; bobbed hammer; smooth trigger. Introduced 1996.

New: \$425 Perf.: \$375 Exc.: \$300

### SMITH & WESSON MODEL 909

Semi-automatic; double action; 9mm Para.; 9-shot magazine; 4" barrel; weighs 27 oz.; 7 3/8" overall length; one-piece Xenoy wrap-around grips with curved backstrap; post front sight with white dot, fixed two-dot rear; alloy frame, blue carbon steel slide; slide mounted decocking lever. Made in U.S. by Smith & Wesson. Introduced 1995; still produced.

New: \$350 Perf.: \$300 Exc.: \$250

### SMITH & WESSON MODEL 910

Semi-automatic; double action; 9mm Para.; 10-shot magazine; 4" barrel; weighs 27 oz.; 7 3/8" overall length; one-piece Xenoy wrap-around grips with curved backstrap; post front sight with white dot, fixed two-dot rear; alloy frame, blue carbon steel slide; slide mounted decocking lever. Introduced 1995; still produced.

New: \$375 Perf.: \$325 Exc.: \$275

### SMITH & WESSON MODEL 915

Semi-automatic; double action; 9mm Para.; 15-shot magazine; 4" barrel; 7 1/2" overall length; weighs 28 1/2 oz.; one-piece Xenoy wrap-around grips with straight backstrap; post front sight with white dot, fixed rear; alloy frame, blue carbon steel slide; slide-mounted decocking lever. Made in U.S. by Smith & Wesson. Introduced 1992; dropped 1995.

New: \$350 Perf.: \$300 Exc.: \$250



Smith & Wesson  
Model 915



Smith & Wesson  
Model 1066



Smith & Wesson  
Model 3913

### SMITH & WESSON MODEL 1006

Semi-automatic; double action; 10mm auto; 9-shot magazine; 5" barrel; weighs 38 oz.; one-piece Xenoy wrap-around grips with straight backstrap; rounded trigger guard; choice of Novak LoMount Carry fixed rear sight with two white dots or adjustable micro-click rear with two white dots; stainless steel construction; satin stainless finish. Introduced 1990; dropped 1993.

Perf.: \$550 Exc.: \$475 VGood: \$400

### SMITH & WESSON MODEL 1026

Semi-automatic; double action; 10mm auto; 9-shot magazine; 5" barrel; weighs 38 oz.; frame mounted decocking lever, fixed sights; one-piece Delrin grips; rounded trigger guard. Introduced 1990; dropped 1992.

Exc.: \$550 VGood: \$500 Good: \$400

### SMITH & WESSON MODEL 1046

Semi-automatic; double-action-only; 10mm auto; 9-shot magazine; 5" barrel; weighs 38 oz.; rounded trigger guard; fixed sights; wrap-around grips with straight backstrap; stainless steel with satin finish. Introduced 1990; dropped 1992.

Exc.: \$525 VGood: \$450 Good: \$375

### SMITH & WESSON MODEL 1066

Semi-automatic; double action; 10mm auto; 9-shot magazine; 4 1/4" barrel; fixed sights; wrap-around grips with straight backstrap; ambidextrous safety. Introduced 1990; dropped 1992.

Exc.: \$500 VGood: \$400 Good: \$350

### Smith & Wesson Model 1066-NS

Same specs as Model 1066 except Tritium night sights.

Exc.: \$550 VGood: \$450 Good: \$400



Smith & Wesson  
Model 1026



Smith & Wesson  
Model 1086



Smith & Wesson  
Model 3904

### SMITH & WESSON MODEL 1076

Semi-automatic; double action; 10mm auto; 9-shot magazine; 4 1/4" barrel; frame mounted decocking lever; wrap-around grips with straight backstrap; fixed sights. Introduced 1990; dropped 1993.

Exc.: \$500 VGood: \$400 Good: \$350

### SMITH & WESSON MODEL 1086

Semi-automatic; double-action-only; 10mm auto; 9-shot magazine; 4 1/4" barrel; wrap-around grips with straight backstrap; fixed sights; ambidextrous safety. Introduced 1990; dropped 1993.

Perf.: \$700 Exc.: \$600 VGood: \$450

### SMITH & WESSON MODEL 3904

Semi-automatic; double action; 9mm Para.; 8-shot magazine; 4" barrel; 7 1/2" overall length; weighs 28 oz.; one-piece wrap-around Delrin stocks; post front sight with white dot, fixed or fully-adjustable two-dot rear; blued finish; smooth trigger; serrated hammer. Introduced 1989; dropped 1991.

Exc.: \$400 VGood: \$350 Good: \$300

### SMITH & WESSON MODEL 3906

Semi-automatic; double action; 9mm Para.; 8-shot magazine; 4" barrel; 7 5/8" overall length; weighs 28 oz.; stainless steel construction; one-piece wrap-around Delrin stocks; post front sight with white dot, fixed or fully-adjustable two-dot rear; blued finish; smooth trigger; serrated hammer. Introduced 1989; dropped 1991.

Exc.: \$450 VGood: \$400 Good: \$350

### SMITH & WESSON MODEL 3913

Semi-automatic; double action; 9mm Para.; 8-shot magazine; 3 1/2" barrel; 6 13/16" overall length; weighs 26 oz.; post white-dot front sight, two-dot windage-adjustable Novak LoMount Carry rear; aluminum alloy frame; stainless steel slide; bobbed hammer; no half-cock notch; smooth trigger; straight backstrap. Introduced 1990; dropped 1999.

New: \$500 Perf.: \$450 Exc.: \$350



# HANDGUNS

## Smith & Wesson Semi-Automatic Pistols

Model 3913 LadySmith  
Model 3913-NL  
Model 3913TSW/3953TSW  
Model 3914  
Model 3914 LadySmith  
Model 3914-NL  
Model 3953  
Model 3954  
Model 4006  
Model 4043  
Model 4013  
Model 4053  
Model 4014  
Model 4046  
Model 4053  
Model 4054



Smith & Wesson  
Model 3914



Smith & Wesson  
Model 4006



Smith & Wesson  
Model 4053



Smith & Wesson  
Model 3914  
LadySmith



Smith & Wesson  
Model 3913  
LadySmith

### SMITH & WESSON MODEL 3913 LADYSMITH

Semi-automatic; double action; 9mm Para.; 8-shot magazine; 3 1/2" barrel; 6 13/16" overall length; weighs 26 oz.; post white-dot front sight, two-dot windage-adjustable Novak LoMount Carry rear; upswept frame at front; rounded trigger guard; frosted stainless steel finish; gray ergonomic grips designed for smaller hands. Introduced 1990; still produced.

New: \$575 Perf.: \$500 Exc.: \$400

### Smith & Wesson Model 3913-NL

Same specs as Model 3913 except without LadySmith logo; slightly modified frame design; right-hand safety only; stainless slide in alloy frame. Introduced 1990; dropped 1994.

Perf.: \$450 Exc.: \$350 VGood: \$275

### Smith & Wesson Model 3913TSW/3953TSW

Similar to the Model 3913 and 3953 except TSW guns have tighter tolerances, ambidextrous manual safety/decocking lever, flush-fit magazine, delayed-unlock firing system. DAO Model 3953 has magazine disconnect. Compact alloy frame, stainless steel slide. Straight backstrap. Introduced 1998.

New: \$600 Perf.: \$525 Exc.: \$450

### SMITH & WESSON MODEL 3914

Semi-automatic; double action; 9mm Para.; 8-shot magazine; 3 1/2" barrel; 6 13/16" overall length; weighs 26 oz.; post white-dot front sight, two-dot windage-adjustable Novak LoMount Carry rear; aluminum alloy frame; blued steel slide; bobbed hammer; no half-cock notch; smooth trigger straight backstrap. Introduced 1990; dropped 1995.

New: \$400 Perf.: \$325 Exc.: \$250

### SMITH & WESSON MODEL 3914 LADYSMITH

Semi-automatic; double action; 9mm Para.; 8-shot magazine; 3 1/2" barrel; 6 13/16" overall length; weighs 26 oz.; post white-dot front sight, two-dot windage-adjustable Novak LoMount Carry rear; same specs as standard 3913, except slide is of blued steel. Introduced 1990; dropped 1992.

Perf.: \$450 Exc.: \$375 VGood: \$275

### Smith & Wesson Model 3914-NL

Same specs as 3914 except without LadySmith logo; slightly modified frame design; right-hand safety only; blued finish, black grips. Introduced 1990; dropped 1991.

Perf.: \$400 Exc.: \$300 VGood: \$250

### SMITH & WESSON MODEL 3953

Semi-automatic; double-action-only; 9mm Para.; 8-shot magazine; 3 1/2" barrel; 7" overall length;

weighs 25 1/2 oz.; post white-dot front sight, two-dot windage-adjustable Novak LoMount Carry rear; aluminum alloy frame; stainless steel slide; bobbed hammer; no half-cock notch; smooth trigger straight backstrap. Introduced 1990; dropped 1999.

New: \$500 Perf.: \$450 Exc.: \$350

### SMITH & WESSON MODEL 3954

Semi-automatic; double-action-only; 9mm Para.; 8-shot magazine; 3 1/2" barrel; 7" overall length; weighs 25 1/2 oz.; post white-dot front sight, two-dot windage-adjustable Novak LoMount Carry rear; aluminum alloy frame; blued steel slide; alloy frame; bobbed hammer; no half-cock notch; smooth trigger straight backstrap. Introduced 1990; dropped 1992.

Perf.: \$400 Exc.: \$350 VGood: \$275

### SMITH & WESSON MODEL 4006

Semi-automatic; 40 S&W; 11-shot magazine; 4" barrel; 7 1/2" overall length; weighs 38 oz.; replaceable white-dot post front sight, Novak two-dot fixed rear or two-dot micro-click adjustable rear; Xenoy wrap-around grips, checkered panels; straight backstrap; made of stainless steel; non-reflective finish. Introduced 1991.

New: \$650 Perf.: \$600 Exc.: \$500

Tritium night sights

New: \$725 Perf.: \$675 Exc.: \$575

### Smith & Wesson Model 4043

Similar to the Model 4006 except is double-action-only. Has a semi-bobbed hammer, smooth trigger, 4" barrel; Novak LoMount Carry rear sight, post front with white dot. Overall length is 7 1/2", weighs 28 oz. Alloy frame. Extra magazine included. Introduced 1991; dropped 1999.

New: \$700 Perf.: \$600 Exc.: \$500

### SMITH & WESSON MODEL 4013

Semi-automatic; double action; 40 S&W; 7-shot magazine; 3 1/2" barrel; 7" overall length; weighs 26 oz.; white-dot post front sight, two-dot Novak LoMount Carry rear; one-piece Xenoy wrap-around grip; straight backstrap; alloy frame; stainless steel slide. Introduced 1991; dropped 1996.

New: \$550 Perf.: \$500 Exc.: \$425

### SMITH & WESSON MODEL 4053 TSW

Semi-automatic; double action; 40 S&W; 9-shot magazine. Barrel: 3 1/2". Weight: 26.4 oz. Length: 6 7/8" overall. Stocks: Checkered black polymer. Sights: Novak three-dot system. Features: double-action only system; stainless slide, alloy frame; fixed barrel bush-

ing; ambidextrous decocker; reversible magazine catch. Introduced 1997.

New: \$725 Perf.: \$625 Exc.: \$550

### SMITH & WESSON MODEL 4014

Semi-automatic; double action; 40 S&W; 7-shot magazine; 3 1/2" barrel; 7" overall length; weighs 26 oz.; blued steel slide; white-dot post front sight, two-dot Novak LoMount Carry rear; one-piece Xenoy wrap-around grip; straight backstrap; alloy frame; stainless steel slide. Introduced 1991; dropped 1993

Perf.: \$500 Exc.: \$450 VGood: \$350

### SMITH & WESSON MODEL 4046

Semi-automatic; double-action-only; 40 S&W; 11-shot; 4" barrel; 7 1/2" overall length; weighs 38 oz.; smooth trigger; semi-bobbed hammer; post white-dot front sight, Novak LoMount Carry rear. Introduced 1991; dropped 1999.

Perf.: \$550 Exc.: \$475 VGood: \$350

### SMITH & WESSON MODEL 4053

Semi-automatic; double-action-only; 40 S&W; 7-shot magazine; 3 1/2" barrel; 7" overall length; weighs 26 oz.; white-dot post front sight, two-dot Novak LoMount Carry rear; one-piece Xenoy wrap-around grip; straight backstrap; alloy frame; stainless steel slide. Introduced 1991; dropped 1997.

New: \$600 Perf.: \$550 Exc.: \$450

### SMITH & WESSON MODEL 4054

Semi-automatic; double-action-only; 40 S&W; 7-shot magazine; 3 1/2" barrel; 7" overall length; weighs 26 oz.; blued steel slide; white-dot post front sight, two-dot Novak LoMount Carry rear; one-piece Xenoy wrap-around grip; straight backstrap; alloy frame; stainless steel slide. Introduced 1991; dropped 1992.

Perf.: \$475 Exc.: \$400 VGood: \$300

# HANDGUNS

## Smith & Wesson Semi-Automatic Pistols

- Model 4505
- Model 4506
- Model 4513TSW/4553TSW
- Model 4516
- Model 4526
- Model 4536
- Model 4546
- Model 4556
- Model 4566
- Model 4567-NS
- Model 4576
- Model 4586
- Model 5903
- Model 5904



Smith & Wesson  
Model 5904



Smith & Wesson  
Model 5903



Smith & Wesson  
Model 4586



Smith & Wesson  
Model 4516



Smith & Wesson  
Model 4506



Smith & Wesson  
Model 5906

### SMITH & WESSON MODEL 4505

Semi-automatic; 45 ACP; 8-shot magazine; 5" barrel; one-piece wrap-around Delrin stock; arched or straight backstrap; post front sight with white dot, fixed or adjustable rear; blued finish. Introduced 1990; dropped 1991.

Perf: \$550 Exc.: \$425 VGood: \$325

### SMITH & WESSON MODEL 4506

Semi-automatic; 45 ACP; 8-shot magazine; 5" barrel; one-piece, wrap-around Xenoy stocks; arched or straight backstrap; post front sight with white dot, fixed or adjustable Novak LoMount Carry rear; serrated hammer spur; stainless steel construction. Introduced 1989; dropped 1999.

New: \$650 Perf: \$550 Exc.: \$475

### SMITH & WESSON MODEL 4513TSW/4553TSW

Semi-automatic; double action; 45 ACP, 6-shot magazine. Barrel: 3 3/4". Weight: 28 oz. (M4513TSW). Length: 6 7/8" overall. Stocks: Checkered Xenoy; straight backstrap. Sights: White dot front, Novak Lo Mount Carry 2-Dot rear. Features: Model 4513TSW is traditional double action, Model 4553TSW is double action only. TSW series has tighter tolerances, ambidextrous manual safety/decocking lever, flush-fit magazine, delayed-unlock firing system. DAO has magazine disconnector. Compact alloy frame, stainless steel slide. Introduced 1998.

Model 4513TSW

New: \$675 Perf.: \$575 Exc.: \$450

Model 4553TSW

New: \$675 Perf.: \$575 Exc.: \$450

### SMITH & WESSON MODEL 4516

Semi-automatic; 45 ACP; 7-shot magazine; 3 3/4" barrel; one-piece wrap-around Xenoy stock; straight backstrap; post front sight with white dot; fixed Novak rear sight; bobbed hammer. Introduced 1989; dropped 1997.

New: \$600 Perf: \$500 Exc.: \$400

### SMITH & WESSON MODEL 4526

Semi-automatic; 45 ACP; 8-shot magazine; 5" barrel; decocking lever; one-piece wrap-around Delrin stock; arched or straight backstrap; post front sight with white dot, fixed or adjustable rear; serrated hammer spur; stainless steel construction. Introduced 1991; dropped 1993.

Perf: \$575 Exc.: \$425 VGood: \$350

### SMITH & WESSON MODEL 4536

Semi-automatic; 45 ACP; 8-shot magazine; 3 3/4" barrel; decocking lever; one-piece wrap-around Delrin stock; arched or straight backstrap; post front sight with white dot, fixed or adjustable rear; serrated ham-

mer spur; stainless steel construction. Introduced 1990; dropped 1991.

Perf: \$575 Exc.: \$425 VGood: \$350

### SMITH & WESSON MODEL 4546

Semi-automatic; double-action-only; 45 ACP; 8-shot magazine; 5" barrel; decocking lever; stainless steel construction; one-piece wrap-around Delrin stock; arched or straight backstrap; post front sight with white dot, fixed or adjustable rear; serrated hammer spur; stainless steel construction. Introduced 1990; dropped 1991.

Perf: \$600 Exc.: \$525 VGood: \$400

### SMITH & WESSON MODEL 4556

Semi-automatic; double-action-only; 45 ACP; 8-shot magazine; 3 3/4" barrel; decocking lever; stainless steel construction; one-piece wrap-around Delrin stock; arched or straight backstrap; post front sight with white dot, fixed or adjustable rear; serrated hammer spur; stainless steel construction. Introduced 1990; dropped 1991.

Perf: \$600 Exc.: \$500 VGood: \$425

### SMITH & WESSON MODEL 4566

Semi-automatic; double-action-only; 45 ACP; 8-shot magazine; 4 1/4" barrel; ambidextrous safety; decocking lever; stainless steel construction; one-piece wrap-around Delrin stocks; arched or straight backstrap; fixed sights; serrated hammer spur; stainless steel construction. Introduced 1990; dropped 1999.

New: \$650 Perf: \$600 Exc.: \$500

### SMITH & WESSON MODEL 4567-NS

Semi-automatic; 45 ACP; 4 1/4" barrel; stainless steel slide; blued steel frame; bobbed hammer; one-piece wrap-around grip; straight, blued backstrap; rounded

edges; Novak sights with tritium inserts. Introduced 1991; dropped 1991.

Perf: \$550 Exc.: \$450 VGood: \$350

### SMITH & WESSON MODEL 4576

Semi-automatic; double action; 45 ACP; 8-shot magazine; 4 1/4" barrel; ambidextrous safety; decocking lever; stainless steel construction; one-piece wrap-around Delrin stocks; arched or straight backstrap; fixed sights; serrated hammer spur made of stainless steel. Introduced 1990; no longer produced.

Perf: \$600 Exc.: \$550 VGood: \$450

### SMITH & WESSON MODEL 4586

Semi-automatic; double-action-only; 45 ACP; 8-shot magazine; 4 1/4" barrel; ambidextrous safety; decocking lever; stainless steel construction; one-piece wrap-around Xenoy stock; arched or straight backstrap; fixed sights; serrated hammer spur. Introduced 1990; dropped 1999.

New: \$650 Perf: \$600 Exc.: \$500

### SMITH & WESSON MODEL 5903

Semi-automatic; double action; 9mm Para.; 14-, 10-shot magazine; 4" barrel; 7 1/2" overall length; weighs 28-37 oz.; stainless steel alloy frame; ambidextrous safety; one-piece wrap-around Xenoy stocks; fixed sights; blued finish; smooth trigger; serrated hammer. Introduced 1989; dropped 1997.

New: \$550 Perf: \$500 Exc.: \$425

### SMITH & WESSON MODEL 5904

Semi-automatic; double action; 9mm Para.; 14-, 10-shot magazine; 4" barrel; 7 1/2" overall length; weighs 28-37 oz.; one-piece wrap-around Xenoy stocks; fixed or adjustable sights; blued finish; smooth trigger; serrated hammer. Introduced 1989; dropped 1998.

New: \$550 Perf: \$500 Exc.: \$400



# HANDGUNS

## Smith & Wesson Semi-Automatic Pistols

Model 5905  
Model 5906  
Model 5924  
Model 5926  
Model 5943  
Model 5943-SSV  
Model 5944  
Model 5946  
Model 6904  
Model 6906  
Model 6926  
Model 6944  
Model 6946  
Sigma SW9F  
Sigma SW9C



Smith & Wesson  
Model 6946



Smith & Wesson  
Model 5946



Smith & Wesson  
Model 6906



Smith & Wesson  
Sigma SW40F



Smith & Wesson  
Sigma SW380

### SMITH & WESSON MODEL 5905

Semi-automatic; double action; 9mm Para.; 14-shot magazine; 4" barrel; 7 5/8" overall length; weighs 30 oz.; blued frame, slide; ambidextrous safety; one-piece wrap-around Delrin stocks; adjustable sights; blued finish; smooth trigger; serrated hammer. Introduced 1989; dropped 1992.

Perf: \$650 Exc.: \$600 VGood: \$550

### SMITH & WESSON MODEL 5906

Semi-automatic; double action; 9mm Para.; 14-, 10-shot magazine; 4" barrel; 7 1/2" overall length; weighs 28-38 oz.; stainless steel construction; ambidextrous safety; one-piece wrap-around Xenoy stock; fixed or adjustable sights; blued finish; smooth trigger; serrated hammer. Introduced 1989; dropped 1999.

New: \$600 Perf: \$525 Exc.: \$425

### SMITH & WESSON MODEL 5924

Semi-automatic; double action; 9mm Para.; 14-shot magazine; 4" barrel; 7 1/2" overall length; weighs 30 oz.; blue frame; frame mounted decocking lever; ambidextrous safety; one-piece wrap-around Delrin stocks; fixed sights; blued finish; smooth trigger; serrated hammer. Introduced 1989; dropped 1992.

Perf: \$450 Exc.: \$350 VGood: \$300

### SMITH & WESSON MODEL 5926

Semi-automatic; double action; 9mm Para.; 14-shot magazine; 4" barrel; 7 1/2" overall length; weighs 30 oz.; stainless steel construction; frame mounted decocking lever; ambidextrous safety; one-piece wrap-around Delrin stocks; fixed sights; blued finish; smooth trigger; serrated hammer. Introduced 1989; dropped 1992.

Perf: \$550 Exc.: \$450 VGood: \$375

### SMITH & WESSON MODEL 5943

Semi-automatic; double-action-only; 9mm Para.; 14-shot magazine; 4" barrel; 7 1/2" overall length; weighs 30 oz.; stainless alloy frame; frame mounted decocking lever; ambidextrous safety; one-piece wrap-around Delrin stocks; fixed sights; blued finish;

smooth trigger; serrated hammer. Introduced 1989; dropped 1992.

Perf: \$500 Exc.: \$450 VGood: \$350

### Smith & Wesson Model 5943-SSV

Same specs as 5943 except 3 1/2" barrel; bobbed hammer; short slide; double-action-only; alloy frame; blued slide, slide stop, magazine release, trigger, hammer; black post front sight, Novak fixed rear tritium inserts; black curved backstrap grips. Introduced 1990; dropped 1992.

Perf: \$525 Exc.: \$475 VGood: \$350

### SMITH & WESSON MODEL 5944

Semi-automatic; double-action-only; 9mm Para.; 14-shot magazine; 4" barrel; 7 1/2" overall length; weighs 30 oz.; blue alloy frame; frame mounted decocking lever; ambidextrous safety; one-piece wrap-around Delrin stocks; fixed sights; blued finish; smooth trigger; serrated hammer. Introduced 1989; dropped 1992.

Perf: \$450 Exc.: \$400 VGood: \$325

### SMITH & WESSON MODEL 5946

Semi-automatic; double-action-only; 9mm Para.; 14-shot magazine; 4" barrel; 7 5/8" overall length; weighs 30 oz.; stainless steel construction; frame mounted decocking lever; ambidextrous safety; one-piece wrap-around Delrin stocks; fixed sights; blued finish; smooth trigger; serrated hammer. Introduced 1989; dropped 1999.

New: \$600 Perf: \$550 Exc.: \$450

### SMITH & WESSON MODEL 6904

Semi-automatic; double action; 9mm Para.; 12-, 10-shot magazine; 3 1/2" barrel; weighs 26 1/2 oz.; fixed rear sight; .260" bobbed hammer; blue finish. Introduced 1989; dropped 1997.

New: \$500 Perf: \$450 Exc.: \$375

### SMITH & WESSON MODEL 6906

Semi-automatic; double action; 9mm Para.; 12-, 10-shot magazine; 3 1/2" barrel; weighs 26 1/2 oz.;

stainless steel construction; fixed rear sight; .260" bobbed hammer. Introduced 1989; dropped 1999.

New: \$550 Perf: \$500 Exc.: \$400

With night sights

New: \$650 Perf: \$600 Exc.: \$500

### SMITH & WESSON MODEL 6926

Semi-automatic; double action; 9mm Para.; 12-shot magazine; 3 1/2" barrel; weighs 26 1/2 oz.; aluminum alloy frame; stainless steel slide; decocking lever; fixed sights; bobbed hammer. Introduced 1990; dropped 1992.

Perf: \$500 Exc.: \$450 VGood: \$350

### SMITH & WESSON MODEL 6944

Semi-automatic; double-action-only; 9mm Para.; 12-shot magazine; 3 1/2" barrel; weighs 26 1/2 oz.; aluminum alloy frame; blued steel slide; decocking lever; fixed sights; bobbed hammer. Introduced 1990; dropped 1992.

Perf: \$450 Exc.: \$400 VGood: \$300

### SMITH & WESSON MODEL 6946

Semi-automatic; double-action-only; 9mm Para.; 12-, 10-shot magazine; 3 1/2" barrel; weighs 26 1/2 oz.; aluminum alloy frame; blued steel slide; decocking lever; fixed sights or night sights; .260" bobbed hammer. Introduced 1990; dropped 1999.

New: \$550 Perf: \$500 Exc.: \$400

With night sights

New: \$625 Perf: \$575 Exc.: \$475

### SMITH & WESSON SIGMA SW9F

Semi-automatic; double action; 9mm Para.; 10-shot magazine; 4 1/2" barrel; 7 1/2" overall length; weighs 26 oz.; integral polymer grips; post front sight with white dot, fixed rear with two dots; tritium night sights optional; ergonomic polymer frame; internal striker firing system; corrosion-resistant slide; Teflon-filled, electroless-nickel coated magazine. Introduced 1994; dropped 1996.

New: \$500 Perf: \$450 Exc.: \$375

With fixed tritium night sights

New: \$575 Perf: \$525 Exc.: \$450

### Smith & Wesson Sigma SW9C

Same specs as the SW9F except 4" barrel; weighs 24 1/2 oz. Introduced 1995; dropped 1998.

New: \$500 Perf: \$450 Exc.: \$375

With fixed tritium night sights

New: \$575 Perf: \$525 Exc.: \$450

# HANDGUNS

## Springfield Armory

- Model 1911-A1 Defender
- Model 1911-A1 Distinguished
- Model 1911-A1 Expert Pistol
- Model 1911-A1 Factory Comp
- Model 1911-A1 High Capacity
- Model V10 Ultra Compact Pistol
- Armory TRP Pistols
- Model 1911-A1 N.M. Hardball
- Model 1911-A1 N.R.A. PPC
- Model 1911-A1 Product Improved Defender
- Model 1911-A1 Trophy Master Competition Pistol
- Model 1911-A1 Trophy Master Competition Expert Pistol
- Model 1911-A1 Trophy Match



Springfield Armory Model 1911-A1 High Capacity



Springfield Armory Model 1911-A1 Defender



Springfield Armory Model V10 Ultra Compact Pistol



Springfield Armory TRP

### Springfield Armory Model 1911-A1 Defender

Same specs as Model 1911-A1 except 45 ACP only; fixed combat-type sights; beveled magazine well; bobbed hammer; extended thumb safety; serrated frontstrap; walnut stocks; marketed with two stainless steel magazines; phosphated finish. Introduced 1988; discontinued 1990.

**New:** \$450    **Perf.:** \$400    **Exc.:** \$325

Blued finish

**New:** \$475    **Perf.:** \$425    **Exc.:** \$350

### Springfield Armory Model 1911-A1 Distinguished

Same specs as the 1911-A1 except full-house pistol with match barrel with compensator; Bo-Mar low-mounted adjustable rear sight; full-length recoil spring guide rod and recoil spring retainer; beveled and polished magazine well; walnut grips; hard chrome finish; 45 ACP; comes with two magazines with slam pads, plastic carrying case. From Springfield, Inc. Introduced 1992.

**New:** \$2200    **Perf.:** \$1850    **Exc.:** \$1500

### Springfield Armory Model 1911-A1 Expert Pistol

Same specs as Model 1911-A1 except triple-chamber tapered cone compensator on match barrel with dove-tailed front sight; lowered and flared ejection port; fully tuned for reliability; bobbed hammer; match trigger; Duotone finish; comes with two magazines, plastic carrying case. From Springfield, Inc. Introduced 1992.

**New:** \$1600    **Perf.:** \$1250    **Exc.:** \$1000

### Springfield Armory Model 1911-A1 Factory Comp

Same specs as the standard 1911-A1 except bushing-type dual-port compensator; adjustable rear sight; extended thumb safety; Videcki speed trigger; beveled magazine well; checkered walnut grips standard. Available in 38 Super or 45 ACP, blue only. From Springfield, Inc. Introduced 1992.

**New:** \$750    **Perf.:** \$650    **Exc.:** \$500

### Springfield Armory Model 1911-A1 High Capacity

Same specs as the Model 1911-A1 except 45 ACP, 9mm; 10-shot magazine; Commander-style hammer; walnut grips; ambidextrous thumb safety; beveled magazine well; plastic carrying case. From Springfield, Inc. Introduced 1993; still produced.

**New:** \$600    **Perf.:** \$500    **Exc.:** \$350

9mm Para.

**New:** \$500    **Perf.:** \$450    **Exc.:** \$375

45 ACP Factory Comp

**New:** \$700    **Perf.:** \$600    **Exc.:** \$500

### 45 ACP Comp Lightweight, matte finish

**New:** \$700    **Perf.:** \$600    **Exc.:** \$500

### 45 ACP Compact, blued

**New:** \$550    **Perf.:** \$475    **Exc.:** \$350

### 45 ACP Compact, stainless steel

**New:** \$650    **Perf.:** \$550    **Exc.:** \$450

### Springfield Armory Model V10 Ultra Compact Pistol

Similar to the 1911A1 Compact except has shorter slide, 3.5" barrel, recoil reducing compensator built into the barrel and slide. Beavertail grip safety, beveled magazine well, "hi-viz" combat sights, Videcki speed trigger, flared ejection port, stainless steel frame, blued slide, match grade barrel, walnut grips. Introduced 1996. From Springfield, Inc.

**New:** \$550    **Perf.:** \$475    **Exc.:** \$400

### Springfield Armory TRP Pistols

Similar to the 1911A1 except 45 ACP only; has checkered front strap and mainspring housing; Novak combat rear sight and matching dovetailed front sight; tuned, polished extractor; oversize barrel link; lightweight speed trigger and combat action job; match barrel and bushing; extended thumb safety and fitted beavertail grip safety; Carry bevel on entire pistol; checkered cocobolo wood grips; comes with two Wilson 8-shot magazines. Frame is engraved "Tactical," both sides of frame with "TRP." Introduced 1998.

Standard with Armory Kote finish

**New:** \$950    **Perf.:** \$800    **Exc.:** \$700

Standard, stainless steel

**New:** \$1000    **Perf.:** \$850    **Exc.:** \$750

Price: Champion, Armory Kote

**New:** \$1100    **Perf.:** \$950    **Exc.:** \$800

### Springfield Armory Model 1911-A1 N.M. Hardball

Same specs as Model 1911-A1 except Bo-Mar adjustable rear sight with undercut front blade; fitted match Videcki trigger with 4-lb. pull; fitted slide to frame; throated National Match barrel and bushing; polished feed ramp; recoil buffer system; tuned extractor; Herrett walnut grips; comes with two magazines, plastic carrying case, test target. From Springfield, Inc. Introduced 1992.

**New:** \$1000    **Perf.:** \$850    **Exc.:** \$650

### Springfield Armory Model 1911-A1 N.R.A. PPC

Specifically designed to comply with NRA rules for PPC competition; custom slide-to-frame fit; polished feed ramp; throated barrel; total internal honing; tuned

extractor; recoil buffer system; fully checkered walnut grips; two fitted magazines; factory test target; custom carrying case. From Springfield, Inc. Introduced 1995; still produced.

**New:** \$1350    **Perf.:** \$1100    **Exc.:** \$900

### Springfield Armory Model 1911-A1 Product Improved Defender

Same specs as Model 1911-A1 except 4 1/4" slide; low-profile three-dot sight system; tapered cone dual-port compensator system; rubberized grips; reverse recoil plug; full-length recoil spring guide; serrated frontstrap; extended thumb safety; skeletonized hammer with modified grip safety to match; Videcki speed trigger; Bi-Tone finish. From Springfield, Inc. Introduced 1991.

**New:** \$800    **Perf.:** \$700    **Exc.:** \$600

### Springfield Armory Model 1911-A1 Trophy Master Competition Pistol

Same specs as Model 1911-A1 except combat-type sights; Pachmayr wrap-around grips; ambidextrous safety; match trigger; bobbed hammer. Introduced 1988; discontinued 1990.

**Perf.:** \$1450    **Exc.:** \$1200    **VGood:** \$950

### Springfield Armory Model 1911-A1 Trophy Master Competition Expert Pistol

Same specs as Model 1911-A1 except match barrel with compensator; wrap-around Pachmayer grips; ambidextrous thumb safety; lowered, flared ejection port; blued finish. Introduced 1988; discontinued 1990.

**Perf.:** \$1600    **Exc.:** \$1350    **VGood:** \$1000

### Springfield Armory Model 1911-A1 Trophy Match

Same specs as Model 1911-A1 except factory accurized; 4- to 5 1/2-lb. trigger pull; click-adjustable rear sight; match-grade barrel and bushing; checkered walnut grips. From Springfield, Inc. Introduced 1994; still produced.

Blue finish

**New:** \$800    **Perf.:** \$700    **Exc.:** \$600

Stainless steel

**New:** \$825    **Perf.:** \$725    **Exc.:** \$650

High Capacity (stainless steel, 10-shot magazine, front slide serrations, checkered slide serrations)

**New:** \$950    **Perf.:** \$800    **Exc.:** \$700





Springfield Armory Panther



Springfield Armory Omega Match



Star Firestar



Springfield Armory Omega



Star Firestar Plus



Star Megastar



Star Model 28

#### Springfield Armory P9 Factory Comp

Same specs as the standard P9 except comes with dual-port compensator system; extended sear safety; extended magazine release; fully-adjustable rear sight; extra-slim competition wood grips; stainless or bi-tone (stainless and blue) finish; overall length is 9 1/2" with 5 1/2" barrel; weighs 34 oz. From Springfield, Inc. Introduced 1992; dropped 1993.

9mm Para., bi-tone finish or stainless

Perf.: \$550 Exc.: \$450 VGood: \$350

40 S&W, bi-tone finish

Perf.: \$575 Exc.: \$475 VGood: \$375

40 S&W, stainless, 45 ACP bi-tone finish

Perf.: \$600 Exc.: \$500 VGood: \$400

45 ACP, stainless

Perf.: \$550 Exc.: \$500 VGood: \$450

#### Springfield Armory Model P9 Subcompact

Same specs as Model P9 except 9mm Para., 40 S&W; 12-shot (9mm), 9-shot (40 S&W); 3 1/2" barrel; weighs 32 oz.; compact slide frame; squared trigger-guard; extended magazine floorplate. Introduced 1990; discontinued 1992.

Perf.: \$350 Exc.: \$300 VGood: \$250

#### Springfield Armory Model P9 Ultra LSP

Same specs as Model P9 except 5" barrel; 8 3/8" overall length; weighs 34 1/4 oz.; long slide ported; rubber or walnut stocks; blued, Parkerized or blue/stainless finish. Introduced 1991; discontinued 1993.

Perf.: \$550 Exc.: \$450 VGood: \$350

Phosphated finish

Perf.: \$575 Exc.: \$475 VGood: \$375

Stainless steel

Perf.: \$600 Exc.: \$500 VGood: \$450

Stainless frame/matte black slide

Perf.: \$600 Exc.: \$525 VGood: \$450

#### SPRINGFIELD ARMORY OMEGA

Semi-automatic; single action; 38 Super, 10mm, 40 S&W, 45 ACP; 5-shot (10mm, 40 S&W), 7-shot (45 ACP), 9-shot (38 Super) magazine; 5", 6" barrel; weighs 46 oz.; polygonal rifling; rubberized

wrap-around grips; removable ramp front sight, fully-adjustable rear. Convertible between calibers; double serrated slide; built on 1911-A1 frame. Made in U.S. by Springfield Armory; now Springfield, Inc. Introduced 1987; discontinued 1990.

Exc.: \$650 VGood: \$500 Good: \$350

#### Springfield Armory Omega Match

Same specs as Omega except adjustable breech face; new extractor system; low profile combat sights; double serrated slide. Introduced 1991; discontinued 1992.

Perf.: \$750 Exc.: \$650 VGood: \$500

#### SPRINGFIELD ARMORY PANTHER

Semi-automatic; double action; 9mm Para., 40 S&W, 45 ACP; 15-shot (9mm Para.), 11-shot (40 S&W), 9-shot (45 ACP); 40 S&W, 11-shot; 45 ACP, 9-shot magazine; 3 3/4" barrel; 7" overall length; weighs 29 oz.; narrow profile checkered walnut grips; low profile blade front sight, windage-adjustable rear; three-dot system; hammer drop and firing pin safeties; serrated front and rear straps; serrated slide top; Commander hammer; frame-mounted slide stop; button magazine release; matte blue finish. From Springfield Armory; now Springfield, Inc. Introduced 1991; dropped 1992.

Perf.: \$500 Exc.: \$400 VGood: \$350

#### STALLARD JS-9

Semi-automatic; single action; 9mm Para.; 8-shot; 4 1/2" barrel; 7 3/4" overall length; weighs 48 oz.; low-profile fixed sights; textured plastic grips; non-glare blued finish. Introduced 1990; still in production.

New: \$120 Perf.: \$100 Exc.: \$80

#### STAR FIRESTAR

Semi-automatic; single action; 9mm Para., 40 S&W; 7-shot (9mm), 6-shot (40 S&W); 3 3/8" barrel; 6 1/2" overall length; weighs 30 oz.; blade front sight, fully-adjustable three-dot rear; ambidextrous safety; blued or Starvel finish. Introduced 1990. Dropped 1993.

New: \$275 Perf.: \$250 Exc.: \$200

#### Star Firestar M45

Same specs as Firestar except 45 ACP; 6-shot magazine; 3 1/2" barrel; 6 13/16" overall length; weighs 35 oz.; reverse-taper Acculine barrel. Imported from Spain by Interarms. Introduced 1992. Production ended when Star went out of business in 1997.

## HANDGUNS

### Springfield Armory

Model P9 Factory Comp  
Model P9 Subcompact  
Model P9 Ultra LSP  
Omega  
Omega Match  
Panther

### Stallard

JS-9

### Star

Firestar  
Firestar M45  
Firestar Plus  
Megastar  
Model 28

Blue finish  
New: \$300 Perf.: \$250 Exc.: \$200

Starvel finish  
New: \$325 Perf.: \$275 Exc.: \$225

#### Star Firestar Plus

Same specs as Firestar except 10-shot (9mm) magazine; also available in 40 S&W and 45 ACP. Imported from Spain by Interarms. Introduced 1994. Production ended 1997.

Blue finish, 9mm

New: \$300 Perf.: \$250 Exc.: \$200

Starvel finish, 9mm

New: \$325 Perf.: \$275 Exc.: \$225

Blue finish, 40 S&W

New: \$350 Perf.: \$300 Exc.: \$250

Starvel finish, 40 S&W

New: \$375 Perf.: \$325 Exc.: \$300

Blue finish, 45 ACP

New: \$375 Perf.: \$325 Exc.: \$300

Starvel finish, 45 ACP

New: \$400 Perf.: \$350 Exc.: \$375

#### STAR MEGASTAR

Semi-automatic; double action; 10mm, 45 ACP; 14-shot (10mm), 12-shot (45 ACP) magazine; 4 9/16" barrel; 8 1/2" overall length; weighs 47 1/2 oz.; checkered composition grips; blade front sight, adjustable rear; steel frame and slide; reverse-taper Acculine barrel. Imported from Spain by Interarms. Introduced 1992. Production ended 1997.

Blue finish, 10mm, 45 ACP

Perf.: \$400 Exc.: \$350 VGood: \$275

Starvel finish, 10mm, 45 ACP

Perf.: \$425 Exc.: \$375 VGood: \$300

#### STAR MODEL 28

Semi-automatic; double action; 9mm Para.; 15-shot; 4 1/4" barrel; 8" overall length; weighs 40 oz.; square blade front sight, square-notch click-adjustable rear; grooved triggerguard face, front and backstraps; checkered black plastic stocks; ambidextrous safety; blued finish. Introduced 1983; discontinued 1984; replaced by Model 30M.

Exc.: \$400 VGood: \$350 Good: \$300

# HANDGUNS

## Sturm Ruger Semi-Automatics

Government Model Stainless  
Mark II Target  
P85 Mark II  
MK-4B Compact Pistol  
P89 DAO  
Ruger P89  
Ruger P89D Decocker  
P90  
P91 DC Decocker  
P93 Compact  
P94  
P94L

### STURM RUGER MARK II GOVERNMENT MODEL STAINLESS

Semi-automatic; 22 LR; 10-shot magazine; 6 7/8" slab-sided barrel; receiver drilled, tapped for Ruger scope base adaptor; checkered walnut grip panels; right-hand thumb rest; blued open sights. Marketed with 1" stainless scope rings, integral base. Introduced 1991; still in production.

New: \$350 Perf.: \$300 Exc.: \$250

#### Sturm Ruger Mark II Target

Same specs as standard model except 5 1/4", 6 7/8" barrel; 11 1/8" overall length; weighs 42 oz.; .125" blade front sight, adjustable micro-click rear; sight radius 93/8". Introduced 1982; still in production.

New: \$250 Perf.: \$200 Exc.: \$165

Stainless steel finish

New: \$300 Perf.: \$250 Exc.: \$200

#### Ruger MK-4B Compact

Similar to the Mark II Standard pistol except has 4" bull barrel, Patridge-type front sight, fully adjustable rear, and smooth laminated hardwood thumbrest stocks. Weighs 38 oz., overall length of 8-3/16". Comes with extra magazine, plastic case, lock. Introduced 1996.

New: \$300 Perf.: \$250 Exc.: \$200

### STURM RUGER P85 MARK II

Semi-automatic; double action, DAO; 9mm Para.; 15-shot magazine; 4 1/2" barrel; 7 13/16" overall length; weighs 32 oz.; windage-adjustable square-notch rear sight, square post front; ambidextrous slide-mounted safety levers; 4140 chrome-moly steel slide; aluminum alloy frame; grooved Xenoy composition stocks; ambidextrous magazine release; blue or stainless finish. Decocker version also available. Introduced 1986; dropped 1992.

New: \$325 Perf.: \$300 Exc.: \$250

Stainless finish

New: \$375 Perf.: \$325 Exc.: \$275

### STURM RUGER P89

Semi-automatic; double action; 9mm Para., 10-shot magazine. Barrel: 4.50". Weight: 32 oz. Length: 7.84" overall. Stocks: Grooved black Xenoy composition. Sights: Square post front, square notch rear adjustable for windage, both with white dot inserts. Features: Double action with ambidextrous slide-mounted safety-levers. Slide is 4140 chrome-moly steel or 400-series stainless steel, frame is a lightweight aluminum alloy. Ambidextrous magazine release. Blue or stainless steel. Introduced 1986; stainless introduced 1990.

New: \$325 Perf.: \$300 Exc.: \$250

Stainless finish

New: \$375 Perf.: \$325 Exc.: \$275



Ruger MK-48 Compact



Sturm Ruger P89I



Sturm Ruger P89 Decocker Model



Sturm Ruger P90 Decocker Model



Sturm Ruger P93 Compact Decocker Model



Sturm Ruger P94

### STURM RUGER P89D Decocker

Similar to the standard P89 except has ambidextrous decocking levers in place of the regular slide-mounted safety. The decocking levers move the firing pin inside the slide where the hammer can not reach it, while simultaneously blocking the firing pin from forward movement-allows shooter to decock a cocked pistol without manipulating the trigger. Conventional thumb decocking procedures are therefore unnecessary. Blue or stainless steel. Introduced 1990.

New: \$325 Perf.: \$300 Exc.: \$250

Stainless finish

New: \$375 Perf.: \$325 Exc.: \$275

### STURM RUGER P89/DAO

Semi-automatic; double action, double-action-only; 9mm Para.; 15-shot magazine; 4 1/2" barrel; 7 13/16" overall length; weighs 32 oz.; improved version of P85 Mark II; windage-adjustable square-notch rear sight, square post front; internal safety; bobbed, spurless hammer; gripping grooves on rear of slide; stainless steel construction. Decocker model also available at no extra cost; blue or stainless (DAO) finish. Marketed with plastic case, extra magazine, loading tool. Introduced 1991; still in production.

New: \$325 Perf.: \$300 Exc.: \$250

Stainless

New: \$400 Perf.: \$350 Exc.: \$300

### STURM RUGER P90

Semi-automatic; double action; 45 ACP; 7-shot magazine; 4 1/2" barrel; 7 15/16" overall length; weighs 33 1/2 oz.; aluminum frame; stainless steel slide; ambidextrous slide-mounted safety levers; square post front, square notch windage-adjustable rear; stainless steel only. Decocker model also available at no extra cost. Introduced 1991; still in production.

New: \$400 Perf.: \$350 Exc.: \$300

### STURM RUGER P91 DC DECOCKER

Semi-automatic; double action, double-action-only; 40 S&W; 11-shot magazine; 4 1/2" barrel; 7 15/16" over-

all length; weighs 33 oz.; ambidextrous slide-mounted safety levers; square post front, windage-adjustable square notch rear with white dot inserts; grooved black Xenoy composition grips; stainless finish. Marketed with plastic case, extra magazine, loading tool. Introduced 1991; dropped 1994.

New: \$400 Perf.: \$350 Exc.: \$300

### STURM RUGER P93 COMPACT

Semi-automatic; double action; 9mm Para.; 10-shot magazine; 3 15/16" barrel; 7 5/16" overall length; weighs 31 oz.; grooved black Xenoy composition grips; square post front sight, square notch windage-adjustable rear with white dot inserts; forward third of the slide tapered and polished to the muzzle; front of the slide crowned with a convex curve; seven finger grooves on slide; 400-series stainless steel slide; lightweight alloy frame. Available as decocker-only or double-action-only. Introduced 1993; still produced.

New: \$425 Perf.: \$375 Exc.: \$325

### STURM RUGER P94

Semi-automatic; double-action-only, decock only, or manual safety; 9mm Para., 40 S&W; 10-shot magazine; 4 1/4" barrel; 7 1/2" overall length; weighs 33 oz.; grooved Xenoy grips; square post front sight, windage-adjustable rear; three-dot system; slide gripping grooves roll over top of slide; ambidextrous safety-levers; ambidextrous decocking levers; matte finish stainless slide and barrel, alloy frame; frame size between full-size P-Series and compact P93. Introduced 1994; still produced.

New: \$350 Perf.: \$300 Exc.: \$275

### Sturm Ruger P94L

Same specs as the KP94 except laser sight mounts in housing cast integrally with frame; Allen-head screws control windage and elevation adjustments. Made in U.S. by Sturm, Ruger. Introduced 1994; still produced for law enforcement only.



# HANDGUNS

## Taurus

- Model 82
- Model 83
- Model 84
- Model 85
- Model 85CH
- Model 86 Target Master
- Model 94
- Model 96 Scout Master
- Model 431
- Model 441
- Model 445, 445CH



Taurus Model 82



Taurus Model 85



Taurus Model 96  
Scout Master



Taurus Model 85 CH



Taurus Model 83



Taurus Model 441



Taurus Model 431

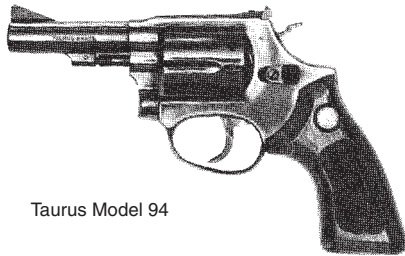

Taurus Model 94



Taurus Model 445, 445CH

### TAURUS MODEL 82

Revolver; double action; 38 Spl.; 6-shot; 3", 4" heavy barrel; 9 1/4" overall length; weighs 34 oz.; fixed sights; checkered Brazilian hardwood grips; blue, satin nickel or stainless steel finish. Introduced 1971; still in production.

**New:** \$200    **Perf.:** \$150    **Exc.:** \$125

Satin nickel finish

**New:** \$225    **Perf.:** \$165    **Exc.:** \$135

Stainless steel

**New:** \$225    **Perf.:** \$175    **Exc.:** \$150

Price: Blue    \$296.00

Price: Stainless    \$344.00

### TAURUS MODEL 83

Revolver; double action; 38 Spl.; 6-shot; 4" heavy barrel; 9 1/2" overall length; weighs 34 oz.; adjustable rear sight, ramp front; hand-checkered oversize Brazilian hardwood grips; blue or stainless steel finish. Introduced 1977; still in production.

**New:** \$200    **Perf.:** \$150    **Exc.:** \$125

Stainless steel

**New:** \$225    **Perf.:** \$185    **Exc.:** \$150

### TAURUS MODEL 84

Revolver; double action; 38 Spl.; 6-shot; 4" barrel; 9 1/2" overall length; adjustable rear sight, ramp front; checkered wood grips; blued finish. Introduced 1971; discontinued 1978.

**Exc.:** \$135    **VGGood:** \$115    **Good:** \$100

### TAURUS MODEL 85

Revolver; double action; 38 Spl.; 5-shot; 2", 3" barrel; weighs 21 oz.; ramp front sight, square-notch rear; checkered Brazilian hardwood grips; blued, satin nickel or stainless finish. Introduced 1980; still imported.

**New:** \$225    **Perf.:** \$200    **Exc.:** \$175

Satin nickel finish

**New:** \$250    **Perf.:** \$225    **Exc.:** \$200

Stainless steel

**New:** \$275    **Perf.:** \$250    **Exc.:** \$225

### TAURUS MODEL 85CH

Same specs as Model 85 except 2" barrel; weighs 21 oz.; smooth Brazilian hardwood grips; concealed hammer. Introduced 1992; still in production.

Blue

**New:** \$225    **Perf.:** \$200    **Exc.:** \$175

Stainless Steel

**New:** \$275    **Perf.:** \$250    **Exc.:** \$225

### TAURUS MODEL 86 TARGET MASTER

Revolver; double action; 38 Spl.; 6-shot cylinder; 6" barrel; 11 1/4" overall length; weighs 34 oz.; oversize target-type grips of checkered Brazilian hardwood; Patridge front sight, micro-click fully-adjustable rear; blue finish with non-reflective finish on barrel. Imported from Brazil by Taurus International. Dropped 1994.

**Perf.:** \$275    **Exc.:** \$225    **VGGood:** \$200

### TAURUS MODEL 94

Revolver; double action; 22 LR; 9-shot; 3", 4" barrel; weighs 25 oz.; serrated ramp front sight, click-adjustable rear; checkered Brazilian hardwood stocks; color case-hardened hammer, trigger; floating firing pin; blued or stainless finish. Introduced 1988; still imported.

**New:** \$225    **Perf.:** \$200    **Exc.:** \$165

Stainless steel

**New:** \$250    **Perf.:** \$225    **Exc.:** \$200

### TAURUS MODEL 94

Revolver, double action; 22 LR, 9-shot cylinder. Barrel: 2", 4", 5". Weight: 25 oz. Stocks: Soft black rubber. Sights: Serrated ramp front, click-adjustable rear for windage and elevation. Features: Floating firing pin, color case-hardened hammer and trigger. Introduced 1989. Imported by Taurus International.

**New:** \$225    **Perf.:** \$175    **Exc.:** \$150

Stainless finish

**New:** \$275    **Perf.:** \$200    **Exc.:** \$175

### TAURUS MODEL 96 SCOUT MASTER

Revolver; double action; 22 LR; 6-shot; 6" barrel; weighs 34 oz.; heavy solid barrel rib; adjustable target

trigger; Patridge type front, micrometer click-adjustable rear; checkered Brazilian hardwood grips; blued finish. Introduced 1971; still in production.

**New:** \$275    **Perf.:** \$225    **Exc.:** \$175

### TAURUS MODEL 431

Revolver; double action; 44 Spl.; 5-shot; 3", 4", 6" barrel; weighs 40 1/2 oz. (6" barrel); checkered Brazilian hardwood grips; serrated ramp front sight, fixed rear; heavy barrel with solid rib and full-length ejector shroud; blue or stainless finish. Imported by Taurus International. Introduced 1992; still imported.

Blue finish

**New:** \$200    **Perf.:** \$175    **Exc.:** \$135

Stainless steel

**New:** \$275    **Perf.:** \$225    **Exc.:** \$185

### TAURUS MODEL 441

Revolver; double action; 44 Spl.; 5-shot cylinder; 3", 4", 6" barrel; weighs 40 1/2 oz. (6" barrel); checkered Brazilian hardwood grips; serrated ramp front sight, micrometer click fully-adjustable rear; heavy barrel with solid rib and full-length ejector shroud; blue or stainless finish. Imported by Taurus International. Introduced 1992; still imported.

Blue finish

**New:** \$225    **Perf.:** \$185    **Exc.:** \$150

Stainless steel

**New:** \$300    **Perf.:** \$250    **Exc.:** \$200

### TAURUS MODEL 445, 445CH

Revolver; double action; 44 Special, 5-shot. Barrel: 2". Weight: 28.25 oz. Length: 6-3/4" overall. Stocks: Soft black rubber. Sights: Serrated ramp front, notch rear. Features: Blue or stainless steel. Standard or concealed hammer. Introduced 1997. Imported by Taurus International.

# HANDGUNS

## Taurus

- Model PT 22
- Model PT 25
- Model PT 58
- Model PT 91AF
- Model PT 92AF
- Model PT 92AFC
- Model PT 99AF
- Model PT 100
- Model PT 101
- Model PT-111 Millennium
- Model PT 908
- Model PT-911

Blue finish		
<b>New:</b> \$250	<b>Perf.:</b> \$200	<b>Exc.:</b> \$175
Stainless steel		
<b>New:</b> \$300	<b>Perf.:</b> \$250	<b>Exc.:</b> \$200

### TAURUS MODEL PT 22

Semi-automatic; double action; 22 LR; 9-shot magazine; 2 3/4" barrel; 5 1/4" overall length; weighs 12 1/2 oz.; smooth Brazilian hardwood grips; blade front sight, fixed rear; tip-up barrel for loading, cleaning. Made in U.S. by Taurus International. Introduced 1992; still produced.

Blue finish		
<b>New:</b> \$165	<b>Perf.:</b> \$135	<b>Exc.:</b> \$110
Stainless steel		
<b>New:</b> \$175	<b>Perf.:</b> \$150	<b>Exc.:</b> \$135

### TAURUS MODEL PT 25

Semi-automatic; double action; 25 ACP; 8-shot magazine; 2 3/4" barrel; 5 1/4" overall length; weighs 12 1/2 oz.; smooth Brazilian hardwood grips; blade front sight, fixed rear; tip-up barrel for loading, cleaning. Made in U.S. by Taurus International. Introduced 1992; still produced.

Blue finish		
<b>New:</b> \$150	<b>Perf.:</b> \$125	<b>Exc.:</b> \$110
Stainless steel		
<b>New:</b> \$175	<b>Perf.:</b> \$150	<b>Exc.:</b> \$135

### TAURUS MODEL PT 58

Semi-automatic; double action; 380 ACP; 12-, 10-shot; 4" barrel; weighs 30 oz.; integral blade front sight, notch rear with three-dot system; Brazilian hardwood stocks; exposed hammer; inertia firing pin; blued finish. Introduced 1988; still imported.

Blue		
<b>New:</b> \$325	<b>Perf.:</b> \$300	<b>Exc.:</b> \$250
Stainless steel		
<b>New:</b> \$400	<b>Perf.:</b> \$350	<b>Exc.:</b> \$300

### TAURUS MODEL PT 91AF

Semi-automatic; double action; 41 AE; 10-shot; 5" barrel; weighs 34 oz.; fixed sights; smooth wood grips; exposed hammer; blued finish. Introduced 1990; discontinued 1991.

<b>Perf.:</b> \$350	<b>Exc.:</b> \$300	<b>VGood:</b> \$250
Satin nickel finish		
<b>Perf.:</b> \$375	<b>Exc.:</b> \$325	<b>VGood:</b> \$275

### TAURUS MODEL PT 92AF

Semi-automatic; double action; 9mm Para.; 15-, 10-shot; 5" barrel; 8 1/2" overall length; weighs 34 oz.; fixed sights; black plastic stocks; exposed hammer; chamber loaded indicator; inertia firing pin; blued, nickel or stainless finish. Introduced 1983; still imported.

Blue, nickel finish		
<b>New:</b> \$425	<b>Perf.:</b> \$375	<b>Exc.:</b> \$325
Stainless steel (PT 92SS)		
<b>New:</b> \$450	<b>Perf.:</b> \$425	<b>Exc.:</b> \$375

### Taurus Model PT 92AFC

Same specs as PT 92AF except 4" barrel; 13-, 10-shot; 7 1/2" overall length; weighs 31 oz. Introduced 1991; still imported.

<b>New:</b> \$350	<b>Perf.:</b> \$325	<b>Exc.:</b> \$275
-------------------	---------------------	--------------------



Taurus Model PT 101



Taurus Model PT 92AF



Taurus Model PT 22



Taurus Model PT 58

Stainless steel		
<b>New:</b> \$400	<b>Perf.:</b> \$350	<b>Exc.:</b> \$300

### TAURUS MODEL PT 99AF

Semi-automatic; double action; 9mm Para.; 15-, 10-shot; 5" barrel; 8 1/2" overall length; adjustable sights; uncheckered Brazilian walnut stocks; exposed hammer; chamber-loaded indicator; inertia firing pin; blue, satin nickel or stainless steel finish. Introduced 1983; still in production.

Blue		
<b>New:</b> \$450	<b>Perf.:</b> \$375	<b>Exc.:</b> \$300
Stainless steel		
<b>New:</b> \$475	<b>Perf.:</b> \$425	<b>Exc.:</b> \$375

### TAURUS MODEL PT 100

Semi-automatic; double action; 40 S&W; 11-, 10-shot; 5" barrel; weighs 34 oz.; fixed sights; three-dot combat system; uncheckered Brazilian hardwood grips; ambidextrous hammer-drop safety; exposed hammer; chamber-loaded indicator; inertia firing pin; blue or stainless steel finish. Introduced 1991; still imported.

Blue		
<b>New:</b> \$450	<b>Perf.:</b> \$400	<b>Exc.:</b> \$325
Stainless steel		
<b>New:</b> \$475	<b>Perf.:</b> \$425	<b>Exc.:</b> \$375

### TAURUS MODEL PT 101

Semi-automatic; double action; 40 S&W; 11-, 10-shot; 5" barrel; 34 oz.; adjustable sights; uncheckered Brazilian hardwood grips; ambidextrous hammer-drop safety; exposed hammer; chamber-loaded indicator; inertia firing pin; blue or stainless steel finish. Introduced 1992; still imported.

Blue		
<b>New:</b> \$450	<b>Perf.:</b> \$375	<b>Exc.:</b> \$300
Stainless steel		
<b>New:</b> \$475	<b>Perf.:</b> \$425	<b>Exc.:</b> \$375

### TAURUS MODEL PT-111 MILLENNIUM

Semi-automatic; double action only; 9mm Para., 10-shot magazine. Barrel: 3.30". Weight: 19 oz. Length: 6.0" overall. Stocks: Polymer. Sights: Fixed.



Taurus Model PT-911

Low profile, three-dot combat. Features: Double action only. Firing pin lock; polymer frame; striker fired; push-button magazine release. Introduced 1998. Imported by Taurus International.

Blue finish		
<b>New:</b> \$275	<b>Perf.:</b> \$225	<b>Exc.:</b> \$185
Stainless steel		
<b>New:</b> \$300	<b>Perf.:</b> \$250	<b>Exc.:</b> \$200

### TAURUS MODEL PT 908

Semi-automatic; double action; 9mm Para.; 8-shot magazine; 3 13/16" barrel; 7" overall length; weighs 30 oz.; checkered black composition grips; drift-adjustable front and rear sights, three-dot combat; exposed hammer; manual ambidextrous hammer-drop; inertia firing pin; chamber loaded indicator; blue or stainless steel finish. Imported by Taurus International. Introduced 1993; still imported.

Blue		
<b>New:</b> \$325	<b>Perf.:</b> \$300	<b>Exc.:</b> \$250
Stainless steel		
<b>New:</b> \$375	<b>Perf.:</b> \$350	<b>Exc.:</b> \$300

### TAURUS MODEL PT-911

Semi-automatic; double action; 9mm Para., 10-shot magazine. Barrel: 3.85". Weight: 28.2 oz. Length: 7.05" overall. Stocks: Black rubber. Sights: Fixed. Low profile, three-dot combat. Features: Double action, exposed hammer; ambidextrous hammer drop; chamber loaded indicator. Introduced 1997. Imported by Taurus International.

Blue finish		
<b>New:</b> \$375	<b>Perf.:</b> \$325	<b>Exc.:</b> \$275
Stainless steel		
<b>New:</b> \$400	<b>Perf.:</b> \$350	<b>Exc.:</b> \$325



# HANDGUNS

## Walther

- Model 4
- Model 5
- Model 6
- Model 7
- Model 8
- Model 8 Lightweight
- Model 9
- Model HP
- Model PP
- Model PP Lightweight
- Model PP Mark II
- Model PP Post-WWII
- Model PPK
- Model PPK American



Walther Model 7

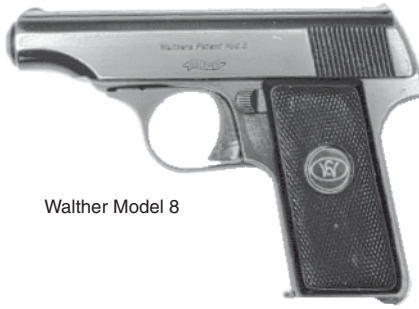

Walther Model 8



Walther Model 4

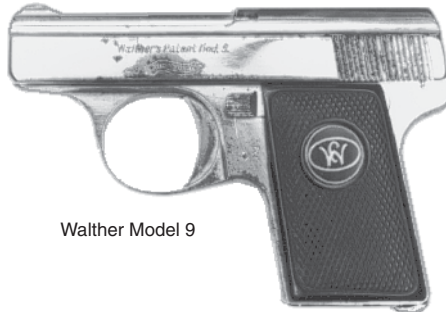

Walther Model 9

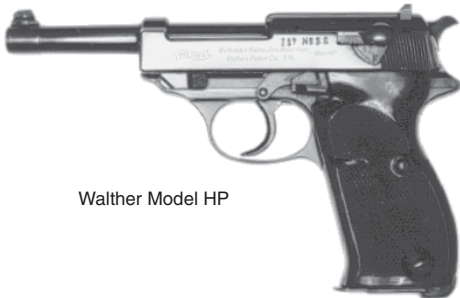

Walther Model HP



Walther Model PP

### WALTHER MODEL 4

Semi-automatic; 32 ACP; 8-shot magazine; 3 1/2" barrel; 5 7/8" overall length; checkered hard rubber stocks; fixed sights; blued finish. Manufactured 1910 to 1920.

Exc.: \$250 VGGood: \$150 Good: \$100

### WALTHER MODEL 5

Semi-automatic; 25 ACP; 6-shot magazine; 2" barrel; 4 7/16" overall length; checkered hard rubber stocks; fixed sights; blued finish. Same specs as Model 2 except better workmanship; improved finish. Manufactured 1913 to 1918; collector value.

Exc.: \$350 VGGood: \$250 Good: \$200

### WALTHER MODEL 6

Semi-automatic; 9mm Para.; 8-shot magazine; 4 3/4" barrel; 8 1/4" overall length; checkered hard rubber stocks; fixed sights; blued finish. Manufactured 1915 to 1917. Rare.

Exc.: \$450 VGGood: \$3500 Good: \$2750

### WALTHER MODEL 7

Semi-automatic; 25 ACP; 8-shot magazine; 3" barrel; 5 5/16" overall length; checkered hard rubber stocks; fixed sights; blued finish. Manufactured 1917 to 1918.

Exc.: \$500 VGGood: \$425 Good: \$350

### WALTHER MODEL 8

Semi-automatic; 25 ACP; 8-shot magazine; 2 7/8" barrel; 5 1/8" overall length; fixed sights; checkered plastic grips; blued. Manufactured by Waffenfabrik Walther, Zella-Mehlis, Germany. Introduced 1920; dropped 1945.

Exc.: \$400 VGGood: \$325 Good: \$275

### Walther Model 8 Lightweight

Same specs as Model 8, except aluminum alloy. Introduced 1927; dropped about 1935.

Exc.: \$1000 VGGood: \$750 Good: \$600

### WALTHER MODEL 9

Semi-automatic; 25 ACP; 6-shot magazine; 2" barrel; 3 15/16" overall length; checkered plastic grips; fixed sights; blued. Introduced 1921; dropped 1945.

Exc.: \$450 VGGood: \$375 Good: \$325

### WALTHER MODEL HP

Semi-automatic; 9mm, 7.65mm Para. (very rare); 10-shot magazine; 5" barrel; 8 3/8" overall length; checkered (early) or grooved plastic or checkered wood (rare) grips; fixed sights; blued. Early examples have rectangular firing pin. Introduced 1939; dropped 1945.

#### Rectangular firing pin

Exc.: \$2250 VGGood: \$1850 Good: \$1200

#### Round firing pin

Exc.: \$1500 VGGood: \$950 Good: \$700

### WALTHER MODEL PP

Semi-automatic; 22 LR, 25 ACP, 32 ACP, 380 ACP; 8-shot magazine; 3 7/8" barrel; 6 5/16" overall length; designed as law-enforcement model; fixed sights; checkered plastic grips; blued. WWII production has less value because of poorer workmanship. Introduced 1929; dropped 1945. RZM, PDM and other special markings bring a premium.

#### Wartime models

Exc.: \$350 VGGood: \$300 Good: \$250

32 caliber

Exc.: \$400 VGGood: \$300 Good: \$225

380 caliber

Exc.: \$1000 VGGood: \$750 Good: \$500

22 caliber

Exc.: \$850 VGGood: \$650 Good: \$450

25 caliber

Exc.: \$3000 VGGood: \$2500 Good: \$2000

### Walther Model PP Lightweight

Same specs as Model PP except aluminum alloy frame. Introduced 1929; dropped 1945.

32 caliber

Exc.: \$750 VGGood: \$450 Good: \$375

380 caliber

Exc.: \$1200 VGGood: \$950 Good: \$700

### Walther Model PP Mark II

Same specs as pre-WWII model. Currently manufactured in France by Manufacture De Machines Du Haut-Rhin. Introduced 1953; still in production, but not imported.

Exc.: \$250 VGGood: \$200 Good: \$175

### Walther Model PP Post-WWII

Same specs as pre-war except not made in 25-caliber. Currently manufactured by Carl Walther Waffenfabrik, Ulm/Donau, West Germany. Still in production. Imported by Interarms.

Exc.: \$350 VGGood: \$275 Good: \$200

### WALTHER MODEL PPK

Semi-automatic; 22 LR, 25 ACP, 32 ACP, 380 ACP; 7-shot magazine; 3 1/4" barrel; 5 7/8" overall length; the Kurz (short) version of the PP; checkered plastic grips; fixed sights; blued finish. WWII production has less value due to poorer workmanship. Introduced 1931; dropped 1945. RZM, PDM and other special markings bring a premium.

#### Wartime models

Exc.: \$350 VGGood: \$300 Good: \$250

32 caliber

Exc.: \$450 VGGood: \$375 Good: \$325

380 caliber

Exc.: \$1250 VGGood: \$950 Good: \$650

22 caliber

Exc.: \$900 VGGood: \$700 Good: \$500

25 caliber

Exc.: \$4500 VGGood: \$4000 Good: \$3500

### Walther Model PPK American

Same specs as PPK except 6-shot magazine; 3 7/8" barrel; 6 5/16" overall length; weighs 21 oz.; 380 ACP only; blued or stainless finish. Made in U.S. Introduced 1986; still marketed by Interarms.

New: \$575 Perf.: \$500 Exc.: \$400

# HANDGUNS — AUTOLOADERS, SERVICE & SPORT

*Includes models suitable for several forms of competition and other sporting purposes.*



Accu-Tek HC-380

Accu-Tek XL-9

Auto-Ordnance 1911A1 Standard

Auto-Ordnance Deluxe

Baer Custom Carry

Baer Premium II

## ACCU-TEK MODEL HC-380 AUTO PISTOL

**Caliber:** 380 ACP, 10-shot magazine. **Barrel:** 2.75". **Weight:** 26 oz. **Length:** 6" overall. **Grips:** Checkered black composition. **Sights:** Blade front, rear adjustable for windage. **Features:** External hammer; manual thumb safety with firing pin and trigger disconnect; bottom magazine release. Stainless steel construction. Introduced 1993. Price includes cleaning kit and gun lock. Made in U.S.A. by Accu-Tek.

**Price:** Satin stainless ..... \$249.00

## ACCU-TEK XL-9 AUTO PISTOL

**Caliber:** 9mm Para., 5-shot magazine. **Barrel:** 3". **Weight:** 24 oz. **Length:** 5.6" overall. **Grips:** Black pebble composition. **Sights:** Three-dot system; rear adjustable for windage. **Features:** Stainless steel construction; double-action-only mechanism. Introduced 1999. Price includes cleaning kit and gun lock, two magazines. Made in U.S.A. by Accu-Tek.

**Price:** ..... \$267.00

## AMERICAN DERRINGER LM-5 AUTOMATIC PISTOL

**Caliber:** 25 ACP, 5-shot magazine. **Barrel:** 2-1/4". **Weight:** 15 oz. **Length:** NA. **Grips:** Wood. **Sights:** Fixed. **Features:** Compact, stainless, semi-auto, single-action hammerless design. Hand assembled and fitted.

**Price:** ..... \$425.00

## AUTO-ORDNANCE 1911A1 AUTOMATIC PISTOL

**Caliber:** 45 ACP, 7-shot magazine. **Barrel:** 5". **Weight:** 39 oz. **Length:** 8-1/2" overall. **Grips:** Checkered plastic with medallion. **Sights:** Blade front, rear adjustable for windage. **Features:** Same specs as 1911A1 military guns-parts interchangeable. Frame and slide blued; each radius has non-glare finish. Made in U.S.A. by Auto-Ordnance Corp.

**Price:** 45 ACP, blue ..... \$511.00

**Price:** 45 ACP, Parkerized ..... \$515.00

**Price:** 45 ACP Deluxe (three-dot sights, textured rubber wraparound grips) ..... \$525.00

## AUTAUGA 32 AUTO PISTOL

**Caliber:** 32 ACP, 6-shot magazine. **Barrel:** 2". **Weight:** 11.3 oz. **Length:** 4.3" overall. **Grips:** Black polymer. **Sights:** Fixed. **Features:** Double-ac-

tion-only mechanism. Stainless steel construction. Uses Winchester Silver Tip ammunition.

**Price:** ..... NA

## BAER 1911 CUSTOM CARRY AUTO PISTOL

**Caliber:** 45 ACP, 7- or 10-shot magazine. **Barrel:** 5". **Weight:** 37 oz. **Length:** 8.5" overall. **Grips:** Checkered walnut. **Sights:** Baer improved ramp-style dovetailed front, Novak low-mount rear. **Features:** Baer forged NM frame, slide and barrel with stainless bushing; fitted slide to frame; double serrated slide (full-size only); Baer speed trigger with 4-lb. pull; Baer deluxe hammer and sear, tactical-style extended ambidextrous safety, beveled magazine well; polished feed ramp and throated barrel; tuned extractor; Baer extended ejector, checkered slide stop; lowered and flared ejection port, full-length recoil guide rod; recoil buff. Partial listing shown. Made in U.S.A. by Les Baer Custom, Inc.

**Price:** Standard size, blued ..... \$1,640.00

**Price:** Standard size, stainless ..... \$1,690.00

**Price:** Comanche size, blued ..... \$1,640.00

**Price:** Comanche size, stainless ..... \$1,690.00

**Price:** Comanche size, aluminum frame, blued slide ..... \$1,923.00

**Price:** Comanche size, aluminum frame, stainless slide ..... \$1,995.00

## BAER 1911 PREMIER II AUTO PISTOL

**Caliber:** 9x23, 38 Super, 400 Cor-Bon, 45 ACP, 7- or 10-shot magazine. **Barrel:** 5". **Weight:** 37 oz. **Length:** 8.5" overall. **Grips:** Checkered rosewood, double diamond pattern. **Sights:** Baer dovetailed front, low-mount Bo-Mar rear with hidden leaf. **Features:** Baer NM forged steel frame and barrel with stainless bushing; slide fitted to frame; double serrated slide; lowered, flared ejection port; tuned, polished extractor; Baer extended ejector, checkered slide stop, aluminum speed trigger with 4-lb. pull, deluxe Commander hammer and sear, beavertail grip safety with pad, beveled magazine well, extended ambidextrous safety; flat mainspring housing; polished feed ramp and throated barrel; 30 lpi checkered front strap. Made in U.S.A. by Les Baer Custom, Inc.

**Price:** Blued ..... \$1,428.00

**Price:** Stainless ..... \$1,558.00

**Price:** 6" model, blued, from ..... \$1,595.00



# HANDGUNS — AUTOLOADERS, SERVICE & SPORT



**Beretta M8000/8040  
Cougar**



**Beretta 96**



**Bersa Thunder 380**

**Beretta Model 86 Cheetah**

Similar to the 380-caliber Model 85 except has tip-up barrel for first-round loading. Barrel length is 4.4", overall length of 7.33". Has 8-shot magazine, walnut grips. Introduced 1989.

**Price:** ..... \$615.00

**Beretta Model 21 Bobcat Pistol**

Similar to the Model 950 BS. Chambered for 22 LR or 25 ACP. Both double action. Has 2.4" barrel, 4.9" overall length; 7-round magazine on 22 cal.; 8 rounds in 25 ACP, 9.9 oz., available in nickel, matte, engraved or blue finish. Plastic grips. Introduced in 1985.

**Price:** Bobcat, 22 or 25, blue ..... \$300.00

**Price:** Bobcat, 22, stainless ..... \$329.00

**Price:** Bobcat, 22 or 25, matte ..... \$265.00

**BERETTA MODEL 3032 TOMCAT PISTOL**

**Caliber:** 32 ACP, 7-shot magazine. **Barrel:** 2.45". **Weight:** 14.5 oz. **Length:** 5" overall. **Grips:** Checkered black plastic. **Sights:** Blade front, drift-adjustable rear. **Features:** Double action with exposed hammer; tip-up barrel for direct loading/unloading; thumb safety; polished or matte blue finish. Imported from Italy by Beretta U.S.A. Introduced 1996.

**Price:** Blue ..... \$393.00

**Price:** Matte ..... \$358.00

**Price:** Stainless ..... \$443.00

**Price:** With Tritium sights ..... \$436.00

**BERETTA MODEL 8000/8040/8045 COUGAR PISTOL**

**Caliber:** 9mm Para., 10-shot, 40 S&W, 10-shot magazine; 45 ACP, 8-shot. **Barrel:** 3.6". **Weight:** 33.5 oz. **Length:** 7" overall. **Grips:** Checkered plastic. **Sights:** Blade front, rear drift adjustable for windage. **Features:** Slide-mounted safety; rotating barrel; exposed hammer. Matte black Bruniton finish. Announced 1994. Imported from Italy by Beretta U.S.A.

**Price:** 8000 and 8000L ..... \$729.00

**Price:** D model, 9mm, 40 S&W ..... \$729.00

**Price:** D model, 45 ACP ..... \$779.00

**Price:** Inox ..... \$794.00

**BERETTA MODEL 9000S COMPACT PISTOL**

**Caliber:** 9mm Para., 40 S&W; 10-shot magazine. **Barrel:** 3.4". **Weight:** 26.8 oz. **Length:** 6.6". **Grips:** Soft polymer. **Sights:** Windage-adjustable white-dot rear, white-dot blade front. **Features:** Glass-reinforced polymer frame; patented tilt-barrel, open-slide locking system; chrome-lined barrel; external serrated hammer; automatic firing pin and manual safeties. Introduced 2000. Imported from Italy by Beretta USA.

**Price:** 9000S Type F (single and double action, external hammer) ..... \$472.00

**BERSA THUNDER LITE 380 AUTO PISTOLS**

**Caliber:** 380 ACP, 7-shot (Thunder 380 Lite), 9-shot magazine (Thunder 380 DLX). **Barrel:** 3.5". **Weight:** 23 oz. **Length:** 6.6" overall. **Grips:** Black polymer. **Sights:** Blade front, notch rear adjustable for windage; three-dot system. **Features:** Double action; firing pin and magazine safeties. Available in blue, nickel, or duo tone. Introduced 1995. Distributed by Eagle Imports, Inc.

**Price:** Thunder 380, 7-shot, deep blue finish ..... \$266.95

**Price:** Thunder 380 Deluxe, 9-shot, satin nickel ..... \$299.95

**Price:** Thunder 380 Gold, 7-shot ..... \$299.95

**BAER 1911 S.R.P. PISTOL**

**Caliber:** 45 ACP. **Barrel:** 5". **Weight:** 37 oz. **Length:** 8.5" overall. **Grips:** Checkered walnut. **Sights:** Trijicon night sights. **Features:** Similar to the F.B.I. contract gun except uses Baer forged steel frame. Has Baer match barrel with supported chamber, Wolff springs, complete tactical action job. All parts Magna-fluxed; deburred for tactical carry. Has Baer Ultra Coat finish. Tuned for reliability. Contact Baer for complete details. Introduced 1996. Made in U.S.A. by Les Baer Custom, Inc.

**Price:** Government or Comanche length ..... \$2,240.00

**BERETTA MODEL 92FS PISTOL**

**Caliber:** 9mm Para., 10-shot magazine. **Barrel:** 4.9". **Weight:** 34 oz. **Length:** 8.5" overall. **Grips:** Checkered black plastic. **Sights:** Blade front, rear adjustable for windage. Tritium night sights available. **Features:** Double action. Extractor acts as chamber loaded indicator, squared trigger guard, grooved front and backstraps, inertia firing pin. Matte or blued finish. Introduced 1977. Made in U.S.A. and imported from Italy by Beretta U.S.A.

**Price:** With plastic grips ..... \$712.00

**Price:** Vertec with access rail ..... \$751.00

**Price:** Vertec Inox ..... \$801.00

**Beretta Model 92FS/96 Brigadier Pistols**

Similar to the Model 92FS/96 except with a heavier slide to reduce felt recoil and allow mounting removable front sight. Wrap-around rubber grips. Three-dot sights dovetailed to the slide, adjustable for windage. Weighs 35.3 oz. Introduced 1999.

**Price:** 9mm or 40 S&W, 10-shot ..... \$772.00

**Price:** Inox models (stainless steel) ..... \$822.00

**Beretta Model 96 Pistol**

Same as the Model 92FS except chambered for 40 S&W. Ambidextrous safety mechanism with passive firing pin catch, slide safety/decocking lever, trigger bar disconnect. Has 10-shot magazine. Available with three-dot sights. Introduced 1992.

**Price:** Model 96, plastic grips ..... \$712.00

**Price:** Stainless, rubber grips ..... \$772.00

**Price:** Vertec with access rail ..... \$751.00

**Price:** Vertec Inox ..... \$801.00

**BERETTA MODEL 80 CHEETAH SERIES DA PISTOLS**

**Caliber:** 380 ACP, 10-shot magazine (M84); 8-shot (M85); 22 LR, 7-shot (M87). **Barrel:** 3.82". **Weight:** About 23 oz. (M84/85); 20.8 oz. (M87). **Length:** 6.8" overall. **Grips:** Glossy black plastic (wood optional at extra cost). **Sights:** Fixed front, drift-adjustable rear. **Features:** Double action, quick takedown, convenient magazine release. Introduced 1977. Imported from Italy by Beretta U.S.A.

**Price:** Model 84 Cheetah, plastic grips ..... \$615.00

**Price:** Model 85 Cheetah, plastic grips, 8-shot ..... \$579.00

**Price:** Model 87 Cheetah, wood, 22 LR, 7-shot ..... \$615.00

**Price:** Model 87 Target, plastic grips ..... \$708.00

# HANDGUNS — AUTOLOADERS, SERVICE & SPORT

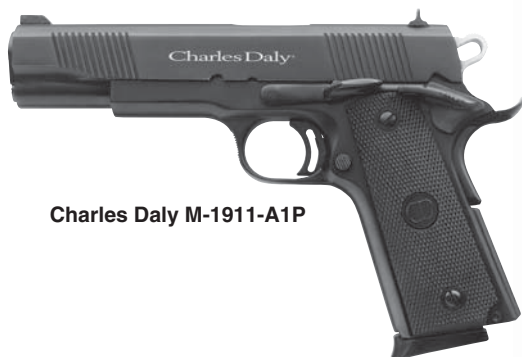

Charles Daly M-1911-A1P



Cobra FS380



Cobra CA32

## Bersa Thunder 45 Ultra Compact Pistol

Similar to the Bersa Thunder 380 except in 45 ACP. Available in three finishes. Introduced 2003. Imported from Argentina by Eagle Imports, Inc.

**Price:** Thunder 45, matte blue ..... \$400.95  
**Price:** Thunder 45, Duotone ..... \$424.95  
**Price:** Thunder 45, Satin nickel ..... \$441.95

## BLUE THUNDER/COMMODORE 1911-STYLE AUTO PISTOLS

**Caliber:** 45 ACP, 7-shot magazine. **Barrel:** 4-1/4", 5". **Weight:** NA. **Length:** NA. **Grips:** Checkered hardwood. **Sights:** Blade front, drift-adjustable rear. **Features:** Extended slide release and safety, spring guide rod, skeletonized hammer and trigger, magazine bumper, beavertail grip safety. Imported from the Philippines by Century International Arms Inc.

**Price:** ..... \$464.80 to \$484.80

## BROWNING HI-POWER 9MM AUTOMATIC PISTOL

**Caliber:** 9mm Para., 10-shot magazine. **Barrel:** 4-21/32". **Weight:** 32 oz. **Length:** 7-3/4" overall. **Grips:** Walnut, hand checkered, or black Polyamide. **Sights:** 1/8" blade front; rear screw-adjustable for windage and elevation. Also available with fixed rear (drift-adjustable for windage). **Features:** External hammer with half-cock and thumb safeties. A blow on the hammer cannot discharge a cartridge; cannot be fired with magazine removed. Fixed rear sight model available. Includes gun lock. Imported from Belgium by Browning.

**Price:** Fixed sight model, walnut grips ..... \$680.00  
**Price:** Fully adjustable rear sight, walnut grips ..... \$730.00  
**Price:** Mark III, standard matte black finish, fixed sight, moulded grips, ambidextrous safety ..... \$662.00

## Browning Hi-Power Practical Pistol

Similar to the standard Hi-Power except has silver-chromed frame with blued slide, wrap-around Pachmayr rubber grips, round-style serrated hammer and removable front sight, fixed rear (drift-adjustable for windage). Available in 9mm Para. Includes gun lock. Introduced 1991.

**Price:** ..... \$717.00

## BROWNING PRO-9

**Caliber:** 9mm Luger, 10-round magazine. **Barrel:** 4". **Weight:** 30 oz. **Overall length:** 7 1/4". **Features:** Double-action, ambidextrous decocker and safety. Fixed, three-dot-style sights, 6" sight radius. Moulded composite grips with interchangeable backstrap inserts.

**Price:** ..... \$628.00

## BROWNING HI-POWER

**Caliber:** 9mm, 40 S&W. **Barrel:** 4 3/4". **Weight:** 32 to 35 oz. **Overall length:** 7 3/4". **Features:** Blued, matte, polymer or silver-chromed frame; moulded, wraparound Pachmayr or walnut grips; Commander-style or spur-type hammer.

**Price:** Practical model, fixed sights ..... \$791.00  
**Price:** Mark II model, epoxy finish ..... \$730.00  
**Price:** HP Standard, blued, fixed sights, walnut grips ..... \$751.00  
**Price:** HP Standard, blued, adj. sights ..... \$805.00

## CHARLES DALY M-1911-A1P AUTOLOADING PISTOL

**Caliber:** 45 ACP, 7- or 10-shot magazine. **Barrel:** 5". **Weight:** 38 oz. **Length:** 8-3/4" overall. **Grips:** Checkered. **Sights:** Blade front, rear drift adjustable for windage; three-dot system. **Features:** Skeletonized combat hammer and trigger; beavertail grip safety; extended slide release; oversize thumb safety; Parkerized finish. Introduced 1996. Imported from the Philippines by K.B.I., Inc.

**Price:** ..... \$469.95

## COBRA ENTERPRISES FS380 AUTO PISTOL

**Caliber:** 380 ACP, 7-shot magazine. **Barrel:** 3.5". **Weight:** 2.1 lbs. **Length:** 6-3/8" overall. **Grips:** Black composition. **Sights:** Fixed. **Features:** Choice of bright chrome, satin nickel or black finish. Introduced 2002. Made in U.S.A. by Cobra Enterprises.

**Price:** ..... \$130.00

## COBRA ENTERPRISES FS32 AUTO PISTOL

**Caliber:** 32 ACP, 8-shot magazine. **Barrel:** 3.5". **Weight:** 2.1 lbs. **Length:** 6-3/8" overall. **Grips:** Black composition. **Sights:** Fixed. **Features:** Choice of black, satin nickel or bright chrome finish. Introduced 2002. Made in U.S.A. by Cobra Enterprises.

**Price:** ..... \$130.00

## COBRA INDUSTRIES PATRIOT PISTOL

**Caliber:** 380ACP, 9mm Luger, 10-shot magazine. **Barrel:** 3.3". **Weight:** 20 oz. **Length:** 6" overall. **Grips:** Checkered polymer. **Sights:** Fixed. **Features:** Stainless steel slide with load indicator; double-action-only trigger system. Introduced 2002. Made in U.S.A. by Cobra Enterprises, Inc.

**Price:** ..... \$279.00

## COBRA INDUSTRIES CA32, CA380

**Caliber:** 32ACP, 380 ACP. **Barrel:** 2.8" **Weight:** 22 oz. **Length:** 5.4". **Grips:** Laminated wood (CA32); Black molded synthetic (CA380). **Sights:** Fixed. **Features:** True pocket pistol size and styling without bulk. Made in U.S.A. by Cobra Enterprises.

**Price:** ..... NA

## COLT MODEL 1991 MODEL O AUTO PISTOL

**Caliber:** 45 ACP, 7-shot magazine. **Barrel:** 5". **Weight:** 38 oz. **Length:** 8.5" overall. **Grips:** Checkered black composition. **Sights:** Ramped blade front, fixed square notch rear, high profile. **Features:** Matte finish. Continuation of serial number range used on original G.I. 1911 A1 guns. Comes with one magazine and moulded carrying case. Introduced 1991.

**Price:** ..... \$645.00  
**Price:** Stainless ..... \$800.00

## Colt Model 1991 Model O Commander Auto Pistol

Similar to the Model 1991 A1 except has 4-1/4" barrel. Overall length is 7-3/4". Comes with one 7-shot magazine, molded case.

**Price:** Blue ..... \$645.00  
**Price:** Stainless steel ..... \$800.00



# HANDGUNS — AUTOLOADERS, SERVICE & SPORT



Colt 1991 Model O



Colt 1991 Model O  
Commander



Colt XSE Model O  
Commander



Colt XSE  
Lightweight  
Commander



Colt Defender



Colt Series 70



Colt 38 Super



Colt Gunsite

Price: ..... \$773.00  
 Price: 41 Magnum Model, from ..... \$825.00

## COLT XSE SERIES MODEL O AUTO PISTOLS

**Caliber:** 45 ACP, 8-shot magazine. **Barrel:** 4.25", 5". **Grips:** Checkered, double diamond rosewood. **Sights:** Drift-adjustable three-dot combat. **Features:** Brushed stainless finish; adjustable, two-cut aluminum trigger; extended ambidextrous thumb safety; upswept beavertail with palm swell; elongated slot hammer; beveled magazine well. Introduced 1999. From Colt's Manufacturing Co., Inc.

**Price:** XSE Government (5" barrel) ..... \$950.00  
**Price:** XSE Commander (4.25" barrel) ..... \$950.00

## COLT XSE LIGHTWEIGHT COMMANDER AUTO PISTOL

**Caliber:** 45 ACP, 8-shot. **Barrel:** 4-1/4". **Weight:** 26 oz. **Length:** 7-3/4" overall. **Grips:** Double diamond checkered rosewood. **Sights:** Fixed, glare-proofed blade front, square notch rear; three-dot system. **Features:** Brushed stainless slide, nicked aluminum frame; McCormick elongated-slot enhanced hammer, McCormick two-cut adjustable aluminum hammer. Made in U.S.A. by Colt's Mfg. Co., Inc.

**Price:** 45, stainless ..... \$950.00

## COLT DEFENDER

**Caliber:** 40 S&W, 45 ACP, 7-shot magazine. **Barrel:** 3". **Weight:** 22-1/2 oz. **Length:** 6-3/4" overall. **Grips:** Pebble-finish rubber wraparound with finger grooves. **Sights:** White dot front, snag-free Colt competition rear. **Features:** Stainless finish; aluminum frame; combat-style hammer; Hi Ride grip safety, extended manual safety, disconnect safety. Introduced 1998. Made in U.S.A. by Colt's Mfg. Co.

## COLT SERIES 70

**Caliber:** 45 ACP. **Barrel:** 5". **Weight:** NA. **Length:** NA. **Grips:** Rosewood with double diamond checkering pattern. **Sights:** Fixed. **Features:** A custom replica of the Original Series 70 pistol with a Series 70 firing system, original rollmarks. Introduced 2002. Made in U.S.A. by Colt's Manufacturing.

**Price:** ..... NA

## COLT 38 SUPER

**Caliber:** 38 Super. **Barrel:** 5". **Weight:** NA. **Length:** 8-1/2". **Grips:** Checkered rubber (stainless and blue models); wood with double diamond checkering pattern (bright stainless model). **Sights:** 3-dot. **Features:** Beveled magazine well, standard thumb safety and service-style grip safety. Introduced 2003. Made in U.S.A. by Colt's Mfg. Co.

**Price:** ..... (Blue) \$864.00 (Stainless steel) \$943.00  
**Price:** ..... (Bright stainless steel) \$1,152.00

## COLT GUNSITE PISTOL

**Caliber:** 45 ACP. **Barrel:** 5". **Weight:** NA. **Length:** NA. **Grips:** Rosewood. **Sights:** Heinie, front; Novak, rear. **Features:** Contains most all of the Gunsite school recommended features such as Series 70 firing system, Smith & Alexander metal grip safety w/palm swell, serrated flat mainspring housing, dehorned all around. Available in blue or stainless steel. Introduced 2003. Made in U.S.A. by Colt's Mfg. Co.

**Price:** ..... NA

# HANDGUNS — AUTOLOADERS, SERVICE & SPORT



CZ 75B 9mm



CZ 75B Decocker



CZ 85



CZ 97B



CZ 100

## CZ 75B AUTO PISTOL

**Caliber:** 9mm Para., 40 S&W, 10-shot magazine. **Barrel:** 4.7". **Weight:** 34.3 oz. **Length:** 8.1" overall. **Grips:** High impact checkered plastic. **Sights:** Square post front, rear adjustable for windage; three-dot system. **Features:** Single action/double action design; firing pin block safety; choice of black polymer, matte or high-polish blue finishes. All-steel frame. Imported from the Czech Republic by CZ-USA.

- Price:** Black polymer . . . . . \$529.00
- Price:** Glossy blue . . . . . \$559.00
- Price:** Dual tone or satin nickel . . . . . \$559.00
- Price:** 22 LR conversion unit . . . . . \$399.00

## CZ 75B Decocker

Similar to the CZ 75B except has a decocking lever in place of the safety lever. All other specifications are the same. Introduced 1999. Imported from the Czech Republic by CZ-USA.

- Price:** 9mm, black polymer . . . . . \$559.00
- Price:** 40 S&W . . . . . \$569.00

## CZ 75B Compact Auto Pistol

Similar to the CZ 75 except has 10-shot magazine, 3.9" barrel and weighs 32 oz. Has removable front sight, non-glare ribbed slide top. Trigger guard is squared and serrated; combat hammer. Introduced 1993. Imported from the Czech Republic by CZ-USA.

- Price:** 9mm, black polymer . . . . . \$559.00
- Price:** Dual tone or satin nickel . . . . . \$569.00
- Price:** D Compact, black polymer . . . . . \$569.00
- Price:** CZ2075 Sub-compact RAMI . . . . . \$559.00

## CZ 75M IPSC Auto Pistol

Similar to the CZ 75B except has a longer frame and slide, slightly larger grip to accommodate new heavy-duty magazine. Ambidextrous thumb safety, safety notch on hammer; two-port in-frame compensator; slide racker; frame-mounted Firepoint red dot sight. Introduced 2001. Imported from the Czech Republic by CZ USA.

- Price:** 40 S&W, 10-shot mag. . . . . \$1,551.00
- Price:** CZ 75 Standard IPSC (40 S&W, adj. sights) . . . . . \$1,038.00

## CZ 85B Auto Pistol

Same gun as the CZ 75 except has ambidextrous slide release and safety-levers; non-glare, ribbed slide top; squared, serrated trigger guard; trigger stop to prevent overtravel. Introduced 1986. Imported from the Czech Republic by CZ-USA.

- Price:** Black polymer . . . . . \$483.00
- Price:** Combat, black polymer . . . . . \$540.00
- Price:** Combat, dual tone . . . . . \$487.00
- Price:** Combat, glossy blue . . . . . \$499.00

## CZ 85 Combat

Similar to the CZ 85B (9mm only) except has an adjustable rear sight, adjustable trigger for overtravel, free-fall magazine, extended magazine catch. Does not have the firing pin block safety. Introduced 1999. Imported from the Czech Republic by CZ-USA.

- Price:** 9mm, black polymer . . . . . \$540.00
- Price:** 9mm, glossy blue . . . . . \$566.00
- Price:** 9mm, dual tone or satin nickel . . . . . \$586.00

## CZ 83B DOUBLE-ACTION PISTOL

**Caliber:** 9mm Makarov, 32 ACP, 380 ACP, 10-shot magazine. **Barrel:** 3.8". **Weight:** 26.2 oz. **Length:** 6.8" overall. **Grips:** High impact checkered plastic. **Sights:** Removable square post front, rear adjustable for windage; three-dot system. **Features:** Single action/double action; ambidextrous magazine release and safety. Blue finish; non-glare ribbed slide top. Imported from the Czech Republic by CZ-USA.

- Price:** Blue . . . . . \$378.00
- Price:** Nickel . . . . . \$397.00

## CZ 97B AUTO PISTOL

**Caliber:** 45 ACP, 10-shot magazine. **Barrel:** 4.85". **Weight:** 40 oz. **Length:** 8.34" overall. **Grips:** Checkered walnut. **Sights:** Fixed. **Features:** Single action/double action; full-length slide rails; screw-in barrel bushing; linkless barrel; all-steel construction; chamber loaded indicator; dual transfer bars. Introduced 1999. Imported from the Czech Republic by CZ-USA.

- Price:** Black polymer . . . . . \$625.00
- Price:** Glossy blue . . . . . \$641.00

## CZ 100 AUTO PISTOL

**Caliber:** 9mm Para., 40 S&W, 10-shot magazine. **Barrel:** 3.7". **Weight:** 24 oz. **Length:** 6.9" overall. **Grips:** Grooved polymer. **Sights:** Blade front with dot, white outline rear drift adjustable for windage. **Features:** Double action only with firing pin block; polymer frame, steel slide; has laser sight mount. Introduced 1996. Imported from the Czech Republic by CZ-USA.

- Price:** 9mm Para. . . . . \$405.00
- Price:** 40 S&W . . . . . \$424.00



# HANDGUNS — AUTOLOADERS, SERVICE & SPORT



**Dan Wesson Firearms  
Pointman Major**

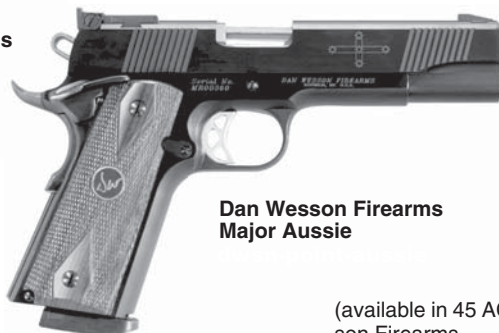

**Dan Wesson Firearms  
Major Aussie**



**Dan Wesson Firearms  
Patriot Marksman**

## DAN WESSON FIREARMS POINTMAN MAJOR AUTO PISTOL

**Caliber:** 45 ACP. **Barrel:** 5". **Grips:** Rosewood checkered. **Features:** Blued or stainless steel frame and serrated slide; Chip McCormick match-grade trigger group, sear and disconnect; match-grade barrel; high-ride beavertail safety; checkered slide release; **Sights:** High rib; interchangeable sight system; laser engraved. Introduced 2000. Made in U.S.A. by Dan Wesson Firearms.

**Price:** Model PM1-B (blued) . . . . . \$799.00  
**Price:** Model PM1-S (stainless) . . . . . \$699.00

## Dan Wesson Firearms Pointman Seven Auto Pistols

Similar to Pointman Major, dovetail adjustable target rear sight and dovetail target front sight. Available in blued or stainless finish. Introduced 2000. Made in U.S.A. by Dan Wesson Firearms.

**Price:** PM7 (blued frame and slide) . . . . . \$999.00  
**Price:** PM7S (stainless finish) . . . . . \$799.00

## Dan Wesson Firearms Pointman Guardian Auto Pistols

Similar to Pointman Major, more compact frame with 4.25" barrel. Available in blued or stainless finish with fixed or adjustable sights. Introduced 2000. Made in U.S.A. by Dan Wesson Firearms.

**Price:** PMG-FS, all new frame (fixed sights) . . . . . \$769.00  
**Price:** PMG-AS (blued frame and slide, adjustable sights) . . . . . \$799.00  
**Price:** PMGD-FS Guardian Duce, all new frame (stainless frame and blued slide, fixed sights) . . . . . \$829.00  
**Price:** PMGD-AS Guardian Duce (stainless frame and blued slide, adj. sights) . . . . . \$799.00

## Dan Wesson Firearms Major Tri-Ops Packs

Similar to Pointman Major. Complete frame assembly fitted to 3 match grade complete slide assembled (9mm, 10mm, 40 S&W). Includes recoil springs and magazines that come in hard cases fashioned after high-grade European rifle case. Constructed of navy blue cordura stretched over hardwood with black leather trim and comfortable black leather wrapped handle. Brass corner protectors, dual combination locks, engraved presentation plate on the lid. Inside, the Tri-Ops Pack components are nested in precision die-cut closed cell foam and held securely in place by convoluted foam in the inside of the lid. Introduced 2002. Made in U.S.A. by Dan Wesson Firearms.

**Price:** TOP1B (blued), TOP1-S (stainless) . . . . . \$2,459.00

## Dan Wesson Firearms Major Aussie

Similar to Pointman Major. Available in 45 ACP. Features Bomar-style adjustable rear target sight, unique slide top configuration exclusive to this model (features radius from the flat side surfaces of the slide to a narrow flat on top and then a small radius and reveal ending in a flat, low (1/16" high) sight rib 3/8" wide with lengthwise serrations). Clearly identified by the Southern Cross flag emblem laser engraved on the sides of the slide

(available in 45 ACP only). Introduced 2002. Made in U.S.A. by Dan Wesson Firearms.

**Price:** PMA-B (blued) . . . . . \$799.00  
**Price:** PMA-S (stainless) . . . . . \$799.00

## Dan Wesson Firearms Pointman Minor Auto Pistol

Similar to Pointman Major. Full size (5") entry level IDPA or action pistol model with blued carbon alloy frame and round top slide, bead blast matte finish on frame and slide top and radius, satin-brushed polished finish on sides of slide, chromed barrel, dovetail mount fixed rear target sight and tactical/target ramp front sight, match trigger, skeletonized target hammer, high ride beavertail, fitted extractor, serrations on thumb safety, slide release and mag release, lowered and relieved ejection port, beveled mag well, exotic hardwood grips, serrated mainspring housing, laser engraved. Introduced 2000. Made in U.S.A. by Dan Wesson Firearms.

**Price:** Model PM2-P . . . . . \$599.00

## Dan Wesson Firearms Pointman Hi-Cap Auto Pistol

Similar to Pointman Minor, full-size high-capacity (10-shot) magazine with 5" chromed barrel, blued finish and dovetail fixed rear sight. Match adjustable trigger, ambidextrous extended thumb safety, beavertail safety. Introduced 2001. From Dan Wesson Firearms.

**Price:** PMHC (Pointman High-Cap) . . . . . \$689.00

## Dan Wesson Firearms Pointman Dave Pruitt Signature Series

Similar to other full-sized Pointman models, customized by Master Pistolsmith and IDPA Grand Master Dave Pruitt. Alloy carbon-steel with black oxide bluing and bead-blast matte finish. Front and rear chevron cocking serrations, dovetail mount fixed rear target sight and tactical/target ramp front sight, ramped match barrel with fitted match bushing and link, Chip McCormick (or equivalent) match grade trigger group, serrated ambidextrous tactical/carry thumb safety, high ride beavertail, serrated slide release and checkered mag release, match grade sear and hammer, fitted extractor, lowered and relieved ejection port, beveled mag well, full length 2-piece recoil spring guide rod, cocobolo double diamond checkered grips, serrated steel mainspring housing, special laser engraving. Introduced 2001. From Dan Wesson Firearms.

**Price:** PMDP (Pointman Dave Pruitt) . . . . . \$899.00

## DAN WESSON FIREARMS PATRIOT 1911 PISTOL

**Caliber:** 45 ACP. **Grips:** Exotic exhibition grade cocobolo, double diamond hand cut checkering. **Sights:** New innovative combat/carry rear sight that completely encloses the dovetail. **Features:** The new Patriot Expert and Patriot Marksman are full size match grade series 70 1911s machined from steel forgings. Available in blued chome moly steel or stainless steel. Beveled mag well, lowered and flared ejection port, high sweep beavertail safety. Introduced June 2002.

**Price:** Model PTM-B (blued) . . . . . \$797.00  
**Price:** Model PTM-S (stainless) . . . . . \$898.00  
**Price:** Model PTE-B (blued) . . . . . \$864.00  
**Price:** Model PTE-S (stainless) . . . . . \$971.00

# HANDGUNS — AUTOLOADERS, SERVICE & SPORT



Desert Baby Eagle



EAA Witness



Ed Brown  
Commander Bobtail



Ed Brown Kobra Carry



Entréprise Elite P500

## DESERT BABY EAGLE PISTOLS

**Caliber:** 9mm Para., 40 S&W, 45 ACP, 10-round magazine. **Barrel:** 3.5", 3.7", 4.72". **Weight:** 26.8 - 39.8 oz. **Length:** 7.25" to 8.25" overall. **Grips:** Polymer. **Sights:** Drift-adjustable rear, blade front. **Features:** Steel frame and slide; polygonal rifling to reduce barrel wear; slide safety; decocker. Reintroduced in 1999. Imported from Israel by Magnum Research Inc.

**Price:** Standard (9mm or 40 cal.; 4.72" barrel, 8.25" overall) . . . . \$499.00

**Price:** Semi-Compact (9mm, 40 or 45 cal.; 3.7" barrel, 7.75" overall) . . . . . \$499.00

**Price:** Compact (9mm or 40 cal.; 3.5" barrel, 7.25" overall) . . . . . \$499.00

**Price:** Polymer (9mm or 40 cal; polymer frame; 3.25" barrel, 7.25" overall) . . . . . \$499.00

## EAA WITNESS DA AUTO PISTOL

**Caliber:** 9mm Para., 10-shot magazine; 38 Super, 40 S&W, 10-shot magazine; 45 ACP, 10-shot magazine. **Barrel:** 4.50". **Weight:** 35.33 oz. **Length:** 8.10" overall. **Grips:** Checkered rubber. **Sights:** Undercut blade front, open rear adjustable for windage. **Features:** Double-action trigger system; round trigger guard; frame-mounted safety. Introduced 1991. Imported from Italy by European American Armory.

**Price:** 9mm, blue . . . . . \$449.00

**Price:** 9mm, Wonder finish . . . . . \$459.00

**Price:** 9mm Compact, blue, 10-shot . . . . . \$449.00

**Price:** As above, Wonder finish . . . . . \$459.00

**Price:** 38 Super, blue . . . . . \$449.00

**Price:** 38 Super, Wonder finish . . . . . \$459.00

**Price:** 40 S&W, blue . . . . . \$449.00

**Price:** As above, Wonder finish . . . . . \$459.00

**Price:** 40 S&W Compact, 9-shot, blue . . . . . \$449.00

**Price:** As above, Wonder finish . . . . . \$459.00

**Price:** 45 ACP, blue . . . . . \$449.00

**Price:** As above, Wonder finish . . . . . \$459.00

**Price:** 45 ACP Compact, 8-shot, blue . . . . . \$449.00

**Price:** As above, Wonder finish . . . . . \$459.00

## ED BROWN CLASSIC CUSTOM

**Caliber:** 45 ACP, 7 shots. **Barrel:** 5". **Weight:** 39 oz. **Stocks:** Cocobolo wood. **Sights:** Bo-Mar adjustable rear, dovetail front. **Features:** Single-action, M1911 style, custom made to order, stainless frame and slide available.

**Price:** . . . . . \$2,895.00

## ED BROWN COMMANDER BOBTAIL

**Caliber:** 45 ACP, 400 Cor-Bon, 40 S&W, 357 SIG, 38 Super, 9mm Luger, 7-shot magazine. **Barrel:** 4.25". **Weight:** 34 oz. **Grips:** Hogue exotic wood. **Sights:** Customer preference front; fixed Novak low-mount, rear. Optional night inserts available. **Features:** Checkered forestrap and bob-tailed mainspring housing. Other options available.

**Price:** Executive Carry . . . . . \$2,295.00

**Price:** Executive Elite . . . . . \$2,195.00

## ED BROWN KOBRA

**Caliber:** 45 ACP, 7-shot magazine. **Barrel:** 5" (Kobra); 4.25" (Kobra Carry). **Weight:** 39 oz. (Kobra); 34 oz. (Kobra Carry). **Grips:** Hogue exotic wood.

**Sights:** Ramp, front; fixed Novak low-mount night sights, rear. **Features:** Has snakeskin pattern serrations on forestrap and mainspring housing, denormed edges, beavertail grip safety.

**Price:** Kobra . . . . . \$1,895.00

**Price:** Kobra Carry . . . . . \$1,995.00

## ENTRÉPRISE ELITE P500 AUTO PISTOL

**Caliber:** 45 ACP, 10-shot magazine. **Barrel:** 5". **Weight:** 40 oz. **Length:** 8.5" overall. **Grips:** Black ultra-slim, double diamond, checkered synthetic. **Sights:** Dovetailed blade front, rear adjustable for windage; three-dot system. **Features:** Reinforced dust cover; lowered and flared ejection port; squared trigger guard; adjustable match trigger; bolstered front strap; high grip cut; high ride beavertail grip safety; steel flat mainspring housing; extended thumb lock; skeletonized hammer, match grade sear, disconnector; Wolff springs. Introduced 1998. Made in U.S.A. by Entréprise Arms.

**Price:** . . . . . \$739.90



# HANDGUNS — AUTOLOADERS, SERVICE & SPORT



**Entréprise  
Tactical 500**



**FEG PJK-9HP**



**FELK MTF 450**



**Firestorm Mini**



**Firestorm 45 Gov't**



**Glock 17C**

## Entréprise Medalist P500 Auto Pistol

Similar to the Elite model except has adjustable Competizione "melded" rear sight with dovetailed Patridge front; machined slide parallel rails with polished breech face and barrel channel; front and rear slide serrations; lowered and flared ejection port; full-length one-piece guide rod with plug; National Match barrel and bushing; stainless firing pin; tuned match extractor; oversize firing pin stop; throated barrel and polished ramp; slide lapped to frame. Introduced 1998. Made in U.S.A. by Entréprise Arms.

**Price:** 45 ACP ..... \$979.00  
**Price:** 40 S&W ..... \$1,099.00

## Entréprise Tactical P500 Auto Pistol

Similar to the Elite model except has Tactical2 Ghost Ring sight or Novak lo-mount sight; ambidextrous thumb safety; front and rear slide serrations; full-length guide rod; throated barrel, polished ramp; tuned match extractor; fitted barrel and bushing; stainless firing pin; slide lapped to frame; dehorned. Introduced 1998. Made in U.S.A. by Entréprise Arms.

**Price:** ..... \$979.90  
**Price:** Tactical Plus (full-size frame, Officer's slide) ..... \$1,049.00

## ERMA KGP68 AUTO PISTOL

**Caliber:** 32 ACP, 6-shot, 380 ACP, 5-shot. **Barrel:** 4". **Weight:** 22-1/2 oz. **Length:** 7-3/8" overall. **Grips:** Checkered plastic. **Sights:** Fixed. **Features:** Toggle action similar to original "Luger" pistol. Action stays open after last shot. Has magazine and sear disconnect safety systems.

**Price:** ..... \$499.95

## FEG PJK-9HP AUTO PISTOL

**Caliber:** 9mm Para., 10-shot magazine. **Barrel:** 4.75". **Weight:** 32 oz. **Length:** 8" overall. **Grips:** Hand-checkered walnut. **Sights:** Blade front, rear adjustable for windage; three dot system. **Features:** Single action; polished blue or hard chrome finish; rounded combat-style serrated hammer. Comes with two magazines and cleaning rod. Imported from Hungary by K.B.I., Inc.

**Price:** Blue ..... \$259.95  
**Price:** Hard chrome ..... \$259.95

## FEG SMC-380 AUTO PISTOL

**Caliber:** 380 ACP, 6-shot magazine. **Barrel:** 3.5". **Weight:** 18.5 oz. **Length:** 6.1" overall. **Grips:** Checkered composition with thumbrest. **Sights:** Blade front, rear adjustable for windage. **Features:** Patterned after the PPK pistol. Alloy frame, steel slide; double action. Blue finish. Comes with two magazines, cleaning rod. Imported from Hungary by K.B.I., Inc.

**Price:** ..... \$224.95

## FELK MTF 450 AUTO PISTOL

**Caliber:** 9mm Para. (10-shot); 40 S&W (8-shot); .357 Mag, 45 ACP (9-shot magazine). **Barrel:** 3.5". **Weight:** 19.9 oz. **Length:** 6.4" overall. **Grips:** Checkered. **Sights:** Blade front; adjustable rear. **Features:** Double-action only trigger, striker fired; polymer frame; trigger safety, firing pin safety, trigger bar safety; adjustable trigger weight; fully interchangeable slide/barrel to change calibers. Introduced 1998. Imported by Felk Inc.

**Price:** ..... \$395.00  
**Price:** 45 ACP pistol with 9mm and 40 S&W slide/barrel assemblies ..... \$999.00

## FIRESTORM AUTO PISTOL

**Features:** 7 or 10 rd. double action pistols with matte, duotone or nickel finish. Distributed by SGS Importers International.

**Price:** 22 LR 10 rd, 380 7 rd. matte ..... \$264.95  
**Price:** Duotone ..... \$274.95  
**Price:** Mini 9mm, 40 S&W, 10 rd. matte ..... \$383.95  
**Price:** Duotone ..... \$391.95  
**Price:** Nickel ..... \$408.95  
**Price:** Mini 45, 7 rd. matte ..... \$383.95  
**Price:** Duotone 45 ..... \$399.95  
**Price:** Nickel 45 ..... \$416.95  
**Price:** 45 Government, Compact, 7 rd. matte ..... \$324.95  
**Price:** Duotone ..... \$333.95  
**Price:** Extra magazines ..... \$29.95-49.95

## GLOCK 17 AUTO PISTOL

**Caliber:** 9mm Para., 10-shot magazine. **Barrel:** 4.49". **Weight:** 22.04 oz. (without magazine). **Length:** 7.32" overall. **Grips:** Black polymer. **Sights:** Dot on front blade, white outline rear adjustable for windage. **Features:** Polymer frame, steel slide; double-action trigger with "Safe Action" system; mechanical firing pin safety, drop safety; simple takedown without tools; locked breech, recoil operated action. Adopted by Austrian armed forces 1983. NATO approved 1984. Imported from Austria by Glock, Inc.

**Price:** Fixed sight, extra magazine, magazine loader, cleaning kit ..... \$641.00  
**Price:** Adjustable sight ..... \$671.00  
**Price:** Model 17L (6" barrel) ..... \$800.00  
**Price:** Model 17C, ported barrel (compensated) ..... \$646.00

# HANDGUNS — AUTOLOADERS, SERVICE & SPORT



Glock 22



Glock 26



Glock 30



Glock 31



Glock 35

## Glock 19 Auto Pistol

Similar to the Glock 17 except has a 4" barrel, giving an overall length of 6.85" and weight of 20.99 oz. Magazine capacity is 10 rounds. Fixed or adjustable rear sight. Introduced 1988.

**Price:** Fixed sight ..... \$641.00  
**Price:** Adjustable sight ..... \$671.00  
**Price:** Model 19C, ported barrel ..... \$646.00

## Glock 20 10mm Auto Pistol

Similar to the Glock Model 17 except chambered for 10mm Automatic cartridge. Barrel length is 4.60", overall length is 7.59", and weight is 26.3 oz. (without magazine). Magazine capacity is 10 rounds. Fixed or adjustable rear sight. Comes with an extra magazine, magazine loader, cleaning rod and brush. Introduced 1990. Imported from Austria by Glock, Inc.

**Price:** Fixed sight ..... \$700.00  
**Price:** Adjustable sight ..... \$730.00

## Glock 21 Auto Pistol

Similar to the Glock 17 except chambered for 45 ACP, 10-shot magazine. Overall length is 7.59", weight is 25.2 oz. (without magazine). Fixed or adjustable rear sight. Introduced 1991.

**Price:** Fixed sight ..... \$700.00  
**Price:** Adjustable sight ..... \$730.00

## Glock 22 Auto Pistol

Similar to the Glock 17 except chambered for 40 S&W, 10-shot magazine. Overall length is 7.28", weight is 22.3 oz. (without magazine). Fixed or adjustable rear sight. Introduced 1990.

**Price:** Fixed sight ..... \$641.00  
**Price:** Adjustable sight ..... \$671.00  
**Price:** Model 22C, ported barrel ..... \$646.00

## Glock 23 Auto Pistol

Similar to the Glock 19 except chambered for 40 S&W, 10-shot magazine. Overall length is 6.85", weight is 20.6 oz. (without magazine). Fixed or adjustable rear sight. Introduced 1990.

**Price:** Fixed sight ..... \$641.00  
**Price:** Model 23C, ported barrel ..... \$646.00  
**Price:** Adjustable sight ..... \$671.00

## GLOCK 26, 27 AUTO PISTOLS

**Caliber:** 9mm Para. (M26), 10-shot magazine; 40 S&W (M27), 9-shot magazine. **Barrel:** 3.46". **Weight:** 21.75 oz. **Length:** 6.29" overall. **Grips:** Integral. Stippled polymer. **Sights:** Dot on front blade, fixed or fully adjustable white outline rear. **Features:** Subcompact size. Polymer frame, steel slide; double-action trigger with "Safe Action" system, three safeties. Matte black Tenifer finish. Hammer-forged barrel. Imported from Austria by Glock, Inc. Introduced 1996.

**Price:** Fixed sight ..... \$641.00  
**Price:** Adjustable sight ..... \$671.00

## GLOCK 29, 30 AUTO PISTOLS

**Caliber:** 10mm (M29), 45 ACP (M30), 10-shot magazine. **Barrel:** 3.78". **Weight:** 24 oz. **Length:** 6.7" overall. **Grips:** Integral. Stippled polymer. **Sights:** Dot on front, fixed or fully adjustable white outline rear. **Features:** Compact size. Polymer frame steel slide; double-recoil spring reduces recoil; Safe Action system with three safeties; Tenifer finish. Two magazines supplied. Introduced 1997. Imported from Austria by Glock, Inc.

**Price:** Fixed sight ..... \$700.00  
**Price:** Adjustable sight ..... \$730.00

## Glock 31/31C Auto Pistols

Similar to the Glock 17 except chambered for 357 Auto cartridge; 10-shot magazine. Overall length is 7.32", weight is 23.28 oz. (without magazine). Fixed or adjustable sight. Imported from Austria by Glock, Inc.

**Price:** Fixed sight ..... \$641.00  
**Price:** Adjustable sight ..... \$671.00  
**Price:** Model 31C, ported barrel ..... \$646.00

## Glock 32/32C Auto Pistols

Similar to the Glock 19 except chambered for the 357 Auto cartridge; 10-shot magazine. Overall length is 6.85", weight is 21.52 oz. (without magazine). Fixed or adjustable sight. Imported from Austria by Glock, Inc.

**Price:** Fixed sight ..... \$616.00  
**Price:** Adjustable sight ..... \$644.00  
**Price:** Model 32C, ported barrel ..... \$646.00

## Glock 33 Auto Pistol

Similar to the Glock 26 except chambered for the 357 Auto cartridge; 9-shot magazine. Overall length is 6.29", weight is 19.75 oz. (without magazine). Fixed or adjustable sight. Imported from Austria by Glock, Inc.

**Price:** Fixed sight ..... \$641.00  
**Price:** Adjustable sight ..... \$671.00



# HANDGUNS — AUTOLOADERS, SERVICE & SPORT



**Heckler & Koch  
USP Compact**



**Heckler & Koch USP45**



**Heckler & Koch  
USP45 Compact**



**Heckler & Koch  
USP45 Tactical**



**Heckler & Koch  
Elite**



**Heckler & Koch  
Mark 23 Special Operations**

## GLOCK 34, 35 AUTO PISTOLS

**Caliber:** 9mm Para. (M34), 40 S&W (M35), 10-shot magazine. **Barrel:** 5.32". **Weight:** 22.9 oz. **Length:** 8.15" overall. **Grips:** Integral. Stippled polymer. **Sights:** Dot on front, fully adjustable white outline rear. **Features:** Polymer frame, steel slide; double-action trigger with "Safe Action" system; three safeties; Tenifer finish. Imported from Austria by Glock, Inc.

**Price:** Model 34, 9mm. . . . . \$770.00  
**Price:** Model 35, 40 S&W . . . . . \$770.00

## GLOCK 36 AUTO PISTOL

**Caliber:** 45 ACP, 6-shot magazine. **Barrel:** 3.78". **Weight:** 20.11 oz. **Length:** 6.77" overall. **Grips:** Integral. Stippled polymer. **Sights:** Dot on front, fully adjustable white outline rear. **Features:** Polymer frame, steel slide; double-action trigger with "Safe Action" system; three safeties; Tenifer finish. Imported from Austria by Glock, Inc.

**Price:** Fixed sight . . . . . \$700.00  
**Price:** Adj. sight . . . . . \$730.00

## HECKLER & KOCH USP AUTO PISTOL

**Caliber:** 9mm Para., 10-shot magazine, 40 S&W, 10-shot magazine, 357 Mag. **Barrel:** 4.25". **Weight:** 28 oz. (USP40). **Length:** 6.9" overall. **Grips:** Non-slip stippled black polymer. **Sights:** Blade front, rear adjustable for windage. **Features:** New HK design with polymer frame, modified Browning action with recoil reduction system, single control lever. Special "hostile environment" finish on all metal parts. Available in SA/DA, DAO, left- and right-hand versions. Introduced 1993. Imported from Germany by Heckler & Koch, Inc.

**Price:** Right-hand . . . . . \$769.00  
**Price:** Left-hand . . . . . \$794.00

## Heckler & Koch USP Compact Auto Pistol

Similar to the USP except has 3.58" barrel, measures 6.81" overall, and weighs 1.60 lbs. (9mm). Available in 9mm Para. 357 SIG or 40 S&W with 10-shot magazine. Introduced 1996. Imported from Germany by Heckler & Koch, Inc.

**Price:** Blue . . . . . \$799.00  
**Price:** Blue with control lever on right . . . . . \$824.00  
**Price:** Same as USP Compact DAO, enhanced trigger performance . . . . . \$799.00

## Heckler & Koch USP45 Auto Pistol

Similar to the 9mm and 40 S&W USP except chambered for 45 ACP, 10-shot magazine. Has 4.13" barrel, overall length of 7.87" and weighs 30.4 oz. Has adjustable three-dot sight system. Available in SA/DA, DAO, left- and right-hand versions. Introduced 1995. Imported from Germany by Heckler & Koch, Inc.

**Price:** Right-hand . . . . . \$839.00  
**Price:** Left-hand . . . . . \$864.00

## Heckler & Koch USP45 Compact

Similar to the USP45 except has stainless slide; 8-shot magazine; modified and contoured slide and frame; extended slide release; 3.80" barrel, 7.09" overall length, weighs 1.75 lbs.; adjustable three-dot sights. Introduced 1998. Imported from Germany by Heckler & Koch, Inc.

**Price:** With control lever on left, stainless . . . . . \$909.00  
**Price:** As above, blue . . . . . \$857.00  
**Price:** With control lever on right, stainless . . . . . \$944.00  
**Price:** As above, blue . . . . . \$892.00

## HECKLER & KOCH USP45 TACTICAL PISTOL

**Caliber:** 45 ACP, 10-shot magazine. **Barrel:** 4.92". **Weight:** 2.24 lbs. **Length:** 8.64" overall. **Grips:** Non-slip stippled polymer. **Sights:** Blade front, fully adjustable target rear. **Features:** Has extended threaded barrel with rubber O-ring; adjustable trigger; extended magazine floorplate; adjustable trigger stop; polymer frame. Introduced 1998. Imported from Germany by Heckler & Koch, Inc.

**Price:** . . . . . \$1,115.00

## HECKLER & KOCH MARK 23 SPECIAL OPERATIONS PISTOL

**Caliber:** 45 ACP, 10-shot magazine. **Barrel:** 5.87". **Weight:** 43 oz. **Length:** 9.65" overall. **Grips:** Integral with frame; black polymer. **Sights:** Blade front, rear drift adjustable for windage; three-dot. **Features:** Polymer frame; double action; exposed hammer; short recoil, modified Browning action. Civilian version of the SOCOM pistol. Introduced 1996. Imported from Germany by Heckler & Koch, Inc.

**Price:** . . . . . \$2,112.00

# HANDGUNS — AUTOLOADERS, SERVICE & SPORT



Heckler & Koch P7M8



Hi-Point 9MM Comp



Kahr K9

## Heckler & Koch USP Expert Pistol

Combines features of the USP Tactical and HK Mark 23 pistols with a new slide design. Chambered for 45 ACP, .40 S&W & 9mm; 10-shot magazine. Has adjustable target sights, 5.20" barrel, 8.74" overall length, weighs 1.87 lbs. Match-grade single- and double-action trigger pull with adjustable stop; ambidextrous control levers; elongated target slide; barrel O-ring that seals and centers barrel. Suited to IPSC competition. Introduced 1999. Imported from Germany by Heckler & Koch, Inc.

**Price:** ..... \$1,869.00

## Heckler & Koch Elite

A long slide version of the USP combining features found on standard-sized and specialized models of the USP. Most noteworthy is the 6.2" barrel, making it the most accurate of the USP series. In 9mm and .45 ACP. Imported from Germany by Heckler & Koch, Inc. Introduced 2003.

**Price:** ..... \$1,569.00

## HECKLER & KOCH P7M8 AUTO PISTOL

**Caliber:** 9mm Para., 8-shot magazine. **Barrel:** 4.13". **Weight:** 29 oz. **Length:** 6.73" overall. **Grips:** Stippled black plastic. **Sights:** Blade front, adjustable rear; three dot system. **Features:** Unique "squeeze cocker" in frontstrap cocks the action. Gas-retarded action. Squared combat-type trigger guard. Blue finish. Compact size. Imported from Germany by Heckler & Koch, Inc.

**Price:** P7M8, blued ..... \$1,515.00

## HECKLER & KOCH P2000 GPM PISTOL

**Caliber:** 9mmx19; 10-shot magazine. 13- or 16-round law enforcement/military magazines. **Barrel:** 3.62". **Weight:** 21.87 ozs. **Length:** 7". **Grips:** Interchangeable panels. **Sights:** Fixed Patridge style, drift adjustable for windage, standard 3-dot. **Features:** German Pistol Model incorporating features of the HK USP Compact such as the pre-cocked hammer system which combines the advantages of a cocked striker with the double action hammer system. Introduced 2003. Imported from Germany by Heckler & Koch, Inc.

**Price:** ..... \$887.00

## HECKLER & KOCH P2000SK SUBCOMPACT

**Caliber:** 9mm and 40 S&W. **Barrel:** 2.48". **Weight:** 1.49 lbs. (9mm) or 1.61 lbs. (40 S&W). **Sights:** Fixed Patridge style, drift adjustable. **Features:** Standard accessory rails, ambidextrous slide release, polymer frame, polygonal bore profile.

**Price:** ..... \$887.00

## HI-POINT FIREARMS 9MM COMP PISTOL

**Caliber:** 9mm, Para., 10-shot magazine. **Barrel:** 4". **Weight:** 39 oz. **Length:** 7.72" overall. **Grips:** Textured acetal plastic. **Sights:** Adjustable; low profile. **Features:** Single-action design. Scratch-resistant, non-glare blue finish, alloy frame. Muzzle brake/compensator. Compensator is slotted for laser or flashlight mounting. Introduced 1998. From MKS Supply, Inc.

**Price:** Matte black ..... \$159.00

## HI-POINT FIREARMS MODEL 9MM COMPACT PISTOL

**Caliber:** 9mm Para., 8-shot magazine. **Barrel:** 3.5". **Weight:** 29 oz. **Length:** 6.7" overall. **Grips:** Textured acetal plastic. **Sights:** Combat-style adjustable three-dot system; low profile. **Features:** Single-action design; frame-mounted magazine release; polymer or alloy frame. Scratch-resistant matte finish. Introduced 1993. Made in U.S.A. by MKS Supply, Inc.

**Price:** Black, alloy frame ..... \$149.00

**Price:** With polymer frame (29 oz.), non-slip grips ..... \$149.00

**Price:** Aluminum with polymer frame ..... \$149.00

## Hi-Point Firearms Model 380 Polymer Pistol

Similar to the 9mm Compact model except chambered for 380 ACP, 8-shot magazine, adjustable three-dot sights. Weighs 29 oz. Polymer frame. Introduced 1998. Made in U.S.A. by MKS Supply.

**Price:** ..... \$114.00

## Hi-Point Firearms 380 Comp Pistol

Similar to the 380 Polymer Pistol except has a 4" barrel with muzzle compensator; action locks open after last shot. Includes a 10-shot and an 8-shot magazine; trigger lock. Introduced 2001. Made in U.S.A. by MKS Supply Inc.

**Price:** ..... \$135.00

**Price:** With laser sight ..... \$229.00

## HI-POINT FIREARMS 45 POLYMER FRAME

**Caliber:** 45 ACP, 9-shot, 40 S&W. **Barrel:** 4.5". **Weight:** 35 oz. **Sights:** Adjustable 3-dot. **Features:** Last round lock-open, grip mounted magazine release, magazine disconnect safety, integrated accessory rail. Introduced 2002. Made in U.S.A. by MKS Supply Inc.

**Price:** ..... \$179.00

## IAI M-2000 PISTOL

**Caliber:** 45 ACP, 8-shot. **Barrel:** 5", (Compact 4.25"). **Weight:** 36 oz. **Length:** 8.5", (6" Compact). **Grips:** Plastic or wood. **Sights:** Fixed. **Features:** 1911 Government U.S. Army-style. Steel frame and slide perforated. GI grip safety. Beveled feed ramp barrel. By IAI, Inc.

**Price:** ..... \$465.00

## KAHR K9, K40 DA AUTO PISTOLS

**Caliber:** 9mm Para., 7-shot, 40 S&W, 6-shot magazine. **Barrel:** 3.5". **Weight:** 25 oz. **Length:** 6" overall. **Grips:** Wrap-around textured soft polymer. **Sights:** Blade front, rear drift adjustable for windage; bar-dot combat style. **Features:** Trigger-cocking double-action mechanism with passive firing pin block. Made of 4140 ordnance steel with matte black finish. Contact maker for complete price list. Introduced 1994. Made in U.S.A. by Kahr Arms.

**Price:** E9, black matte finish ..... \$425.00

**Price:** Matte black, night sights 9mm ..... \$668.00

**Price:** Matte stainless steel, 9mm ..... \$638.00

**Price:** 40 S&W, matte black ..... \$580.00

**Price:** 40 S&W, matte black, night sights ..... \$668.00

**Price:** 40 S&W, matte stainless ..... \$638.00

**Price:** K9 Elite 98 (high-polish stainless slide flats, Kahr combat trigger), from ..... \$694.00

**Price:** As above, MK9 Elite 98, from ..... \$694.00

**Price:** As above, K40 Elite 98, from ..... \$694.00

**Price:** Covert, black, stainless slide, short grip ..... \$599.00

**Price:** Covert, black, tritium nite sights ..... \$689.00



# HANDGUNS — AUTOLOADERS, SERVICE & SPORT



**Kahr MK40**



**Kel-Tec P-11**



**Kel-Tec P-32**

## Kahr K9 9mm Compact Polymer Pistol

Similar to K9 steel frame pistol except has polymer frame, matte stainless steel slide. Barrel length 3.5"; overall length 6"; weighs 17.9 oz. Includes two 7-shot magazines, hard polymer case, trigger lock. Introduced 2000. Made in U.S.A. by Kahr Arms.

**Price:** ..... \$599.00

## Kahr MK9/MK40 Micro Pistol

Similar to the K9/K40 except is 5.5" overall, 4" high, has a 3" barrel. Weighs 22 oz. Has snag-free bar-dot sights, polished feed ramp, dual recoil spring system, DAO-only trigger. Comes with 6- and 7-shot magazines. Introduced 1998. Made in U.S.A. by Kahr Arms.

**Price:** Matte stainless ..... \$638.00

**Price:** Elite 98, polished stainless, tritium night sights ..... \$791.00

## KAHR PM9 PISTOL

**Caliber:** 9x19. **Barrel:** 3", 1:10 twist. **Weight:** 15.9 oz. **Length:** 5.3" overall.

**Features:** Lightweight black polymer frame, polygonal rifling, stainless steel slide, DAO with passive striker block, trigger lock, hard case, 6 and 7 rd. mags.

**Price:** Matte stainless slide ..... \$622.00

**Price:** Tritium night sights ..... \$719.00

## KEL-TEC P-11 AUTO PISTOL

**Caliber:** 9mm Para., 10-shot magazine. **Barrel:** 3.1". **Weight:** 14 oz.

**Length:** 5.6" overall. **Grips:** Checkered black polymer. **Sights:** Blade front, rear adjustable for windage. **Features:** Ordnance steel slide, aluminum frame. Double-action-only trigger mechanism. Introduced 1995. Made in U.S.A. by Kel-Tec CNC Industries, Inc.

**Price:** Blue ..... \$314.00

**Price:** Hard chrome ..... \$368.00

**Price:** Parkerized ..... \$355.00

## KEL-TEC P-32 AUTO PISTOL

**Caliber:** 32 ACP, 7-shot magazine. **Barrel:** 2.68". **Weight:** 6.6 oz. **Length:** 5.07" overall.

**Grips:** Checkered composite. **Sights:** Fixed. **Features:** Double-action-only mechanism with 6-lb. pull; internal slide stop. Textured composite grip/frame. Now available in 380 ACP. Made in U.S.A. by Kel-Tec CNC Industries, Inc.

**Price:** Blue ..... \$300.00

**Price:** Hard chrome ..... \$340.00

**Price:** Parkerized ..... \$355.00

## KIMBER CUSTOM II AUTO PISTOL

**Caliber:** 45 ACP, 40 S&W, .38 Super, 9 mm. **Barrel:** 5", match grade; 9 mm, .40 S&W, .38 Super barrels ramped. **Weight:** 38 oz. **Length:** 8.7" overall.

**Grips:** Checkered black rubber, walnut, rosewood. **Sights:** Dove-tail front and rear, Kimber low profile adj. or fixed three dot (green) Mep-trolight night sights. **Features:** Slide, frame and barrel machined from steel or stainless steel. Match grade barrel, chamber and trigger group. Extended thumb safety, beveled magazine well, beveled front and rear slide serrations, high ride beavertail grip safety, checkered flat mainspring housing, kidney cut under trigger guard, high cut grip, match grade stainless steel barrel bushing, polished breech face, Commander-style hammer, lowered and flared ejection port, Wolff springs, bead blasted black oxide finish. Introduced in 1996. Made in U.S.A. by Kimber Mfg., Inc.



**Kimber Custom II**



**Kimber Pro Carry II**

**Price:** Custom ..... \$745.00

**Price:** Custom Walnut (double-diamond walnut grips) ..... \$767.00

**Price:** Custom Stainless ..... \$848.00

**Price:** Custom Stainless 40 S&W ..... \$799.00

**Price:** Custom Stainless Target 45 ACP (stainless, adj. sight) . . . \$989.00

**Price:** Custom Stainless Target 38 Super ..... \$994.00

## Kimber Stainless II Auto Pistol

Similar to Custom II except has stainless steel frame, 4" bbl., grip is .400" shorter than standard, no front serrations. Weighs 34 oz. 45 ACP only. Introduced in 1998. Made in U.S.A. by Kimber Mfg., Inc.

**Price:** ..... \$964.00

## Kimber Pro Carry II Auto Pistol

Similar to Custom II, has aluminum frame, 4" bull barrel fitted directly to the slide without bushing. HD with stainless steel frame. Introduced 1998. Made in U.S.A. by Kimber Mfg., Inc.

**Price:** Pro Carry ..... \$789.00

**Price:** Pro Carry w/night sights ..... \$893.00

**Price:** Pro Carry Stainless w/night sights ..... \$862.00

**Price:** Pro Carry HD II 38 Super ..... \$936.00

## Kimber Ultra Carry II Auto Pistol

Similar to Compact Stainless II, lightweight aluminum frame, 3" match grade bull barrel fitted to slide without bushing. Grips .400" shorter. Special slide stop. Low effort recoil. Weighs 25 oz. Introduced in 1999. Made in U.S.A. by Kimber Mfg., Inc.

**Price:** ..... \$783.00

**Price:** Stainless ..... \$858.00

**Price:** Stainless 40 S&W ..... \$903.00

# HANDGUNS — AUTOLOADERS, SERVICE & SPORT



**Kimber  
Ultra Carry II**



**Kimber Ten II  
High Capacity Polymer**



**Kimber Gold Match II**



**Kimber Gold Combat II**



**Kimber CDP II**



**Kimber Eclipse II**



**Kimber Eclipse Pro II**

## Kimber Ten II High Capacity Polymer Pistol

Similar to Custom II, Pro Carry II and Ultra Carry II depending on barrel length. Ten-round magazine capacity (double stack and flush fitting). Polymer grip frame molded over stainless steel or aluminum (BP Ten pistols only) frame insert. Checkered front strap and belly of trigger guard. All models have fixed sights except Gold Match Ten II, which has adjustable sight. Frame grip dimensions approximate that of the standard 1911 for natural aiming and better recoil control. **Weight:** 24 to 34 oz. Improved version of the Kimber Polymer series. Made in U.S.A. by Kimber Mfg., Inc.

**Price:** Pro Carry Ten II ..... **\$828.00**

**Price:** Stainless Ten II ..... **\$812.00**

## Kimber Gold Match II Auto Pistol

Similar to Custom II models. Includes stainless steel barrel with match grade chamber and barrel bushing, ambidextrous thumb safety, adjustable sight, premium aluminum trigger, hand-checked double diamond rosewood grips. Barrel hand-fitted to bushing and slide for target accuracy. Made in U.S.A. by Kimber Mfg., Inc.

**Price:** Gold Match II ..... **\$1,192.00**

**Price:** Gold Match Stainless II 45 ACP ..... **\$1,342.00**

**Price:** Gold Match Stainless II 40 S&W ..... **\$1,373.00**

## Kimber Gold Match Ten II Polymer Auto Pistol

Similar to Stainless Gold Match II. High capacity polymer frame with 10-round magazine. No ambi thumb safety. Polished flats add elegant look. Introduced 1999. Made in U.S.A. by Kimber Mfg., Inc.

**Price:** ..... **\$1,373.00**

## Kimber Gold Combat II Auto Pistol

Similar to Gold Match II except designed for concealed carry. Extended and beveled magazine well, Meprolight tritium night sights; premium aluminum trigger; 30 lpi front strap checkering; special Custom Shop markings; KimPro premium finish. Introduced 1999. Made in U.S.A. by Kimber Mfg., Inc.

**Price:** 45 ACP ..... **\$1,716.00**

**Price:** Stainless (stainless frame and slide, special markings) . . **\$1,657.00**

## Kimber CDP II Series Auto Pistol

Similar to Custom II, but designed for concealed carry. Aluminum frame. Standard features include stainless steel slide, Meprolight tritium three-dot (green) dovetail-mounted night sights, match grade barrel and chamber, 30 lpi front strap checkering, two tone finish, ambidextrous thumb

safety, hand-checked double diamond rosewood grips. Introduced in 2000. Made in U.S.A. by Kimber Mfg., Inc.

**Price:** Ultra CDP II 40 S&W ..... **\$1,165.00**

**Price:** Ultra CDP II (3" barrel, short grip) ..... **\$1,165.00**

**Price:** Compact CDP II (4" barrel, short grip) ..... **\$1,165.00**

**Price:** Pro CDP II (4" barrel, full length grip) ..... **\$1,165.00**

**Price:** Custom CDP II (5" barrel, full length grip) ..... **\$1,203.00**

## Kimber Eclipse II Series Auto Pistol

Similar to Custom II and other stainless Kimber pistols. Stainless slide and frame, black anodized, two tone finish. Gray/black laminated grips. 30 lpi front strap checkering. All have night sights, with Target versions having Meprolight adjustable Bar/Dot version. Made in U.S.A. by Kimber Mfg., Inc.

**Price:** Eclipse Ultra II (3" barrel, short grip) ..... **\$1,074.00**

**Price:** Eclipse Pro II (4" barrel, full length grip) ..... **\$1,074.00**

**Price:** Eclipse Pro Target II (4" barrel, full length grip, adjustable sight) ..... **\$1,177.00**

**Price:** Eclipse Custom II (5" barrel, full length grip) ..... **\$1,077.00**

**Price:** Eclipse Target II (5" barrel, full length grip, adjustable sight) ..... **\$1,177.00**

## Kimber Super Match II Auto Pistol

Similar to Gold Match II. Built for target and action shooting competition. Tested for accuracy. Target included. Stainless steel barrel and chamber. KimPro finish on stainless steel slide. Stainless steel frame. 30 lpi checkered front strap, premium aluminum trigger, Kimber adjustable sight. Introduced in 1999.

**Price:** ..... **\$1,966.00**



# HANDGUNS — AUTOLOADERS, SERVICE & SPORT



Llama Micromax 380



Llama Minimax



Llama Max-1  
Government Deluxe

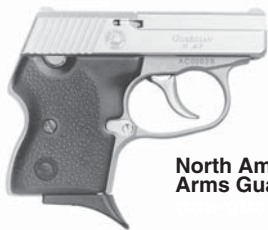

North American  
Arms Guardian



Para-Ordnance P12.45



Para-Ordnance LDA

## KORTH PISTOL

**Caliber:** .40 S&W, .357 SIG (9-shot); 9mm Para, 9x21 (10-shot). **Barrel:** 4" (standard), 5" (optional). **Trigger Weight:** 3.3 lbs. (single Action), 11 lbs. (double action). **Sights:** Fully adjustable. **Features:** All parts of surface-hardened steel; recoil-operated action, mechanically-locked via large pivoting bolt block maintaining parallel positioning of barrel during the complete cycle. Accessories include sound suppressor for qualified buyers. Imported by Korth USA.

**Price:** ..... \$5,602.00

## LLAMA MICROMAX 380 AUTO PISTOL

**Caliber:** 32 ACP, 8-shot, 380 ACP, 7-shot magazine. **Barrel:** 3-11/16". **Weight:** 23 oz. **Length:** 6-1/2" overall. **Grips:** Checkered high impact polymer. **Sights:** 3-dot combat. **Features:** Single-action design. Mini custom extended slide release; mini custom extended beavertail grip safety; combat-style hammer. Introduced 1997. Distributed by Import Sports, Inc.

**Price:** Matte blue ..... \$291.95

**Price:** Satin chrome (380 only) ..... \$308.95

## LLAMA MINIMAX SERIES

**Caliber:** 40 S&W, 7-shot; 45 ACP, 6-shot magazine. **Barrel:** 3-1/2". **Weight:** 35 oz. **Length:** 7-1/3" overall. **Grips:** Checkered rubber. **Sights:** Three-dot combat. **Features:** Single action, skeletonized combat-style hammer, extended slide release, cone-style barrel, flared ejection port. Introduced 1996. Distributed by Import Sports, Inc.

**Price:** Blue ..... \$341.95

**Price:** Duo-Tone finish (45 only) ..... \$349.95

**Price:** Satin chrome ..... \$358.95

## Llama Minimax Sub-Compact Auto Pistol

Similar to the Minimax except has 3.14" barrel, weighs 31 oz.; 6.8" overall length; has 10-shot magazine with finger extension; beavertail grip safety. Introduced 1999. Distributed by Import Sports, Inc.

**Price:** 45 ACP, matte blue ..... \$358.95

**Price:** As above, satin chrome ..... \$374.95

**Price:** Duo-Tone finish (45 only) ..... \$366.95

## LLAMA MAX-I AUTO PISTOLS

**Caliber:** 45 ACP, 7-shot. **Barrel:** 5-1/8". **Weight:** 36 oz. **Length:** 8-1/2" overall. **Grips:** Polymer. **Sights:** Blade front; three-dot system. **Features:** Single-action trigger; skeletonized combat-style hammer; steel

frame; extended manual and grip safeties, matte finish. Introduced 1995. Distributed by Import Sports, Inc.

**Price:** 45 ACP, 7-shot, Government model ..... \$358.95

## NORTH AMERICAN ARMS GUARDIAN PISTOL

**Caliber:** 32 ACP, 380 ACP, 32NAA, 6-shot magazine. **Barrel:** 2.1". **Weight:** 13.5 oz. **Length:** 4.36" overall. **Grips:** Black polymer. **Sights:** Fixed. **Features:** Double-action-only mechanism. All stainless steel construction; snag-free. Introduced 1998. Made in U.S.A. by North American Arms.

**Price:** ..... \$402.00 to \$479.00

## PARA-ORDNANCE P-SERIES AUTO PISTOLS

**Caliber:** 9mm Para., 40 S&W, 45 ACP, 10-shot magazine. **Barrel:** 3", 3-1/2", 4-1/4", 5". **Weight:** From 24 oz. (alloy frame). **Length:** 8.5" overall. **Grips:** Textured composition. **Sights:** Blade front, rear adjustable for windage. High visibility three-dot system. **Features:** Available with alloy, steel or stainless steel frame with black finish (silver or stainless gun). Steel and stainless steel frame guns weigh 40 oz. (P14.45), 36 oz. (P13.45), 34 oz. (P12.45). Grooved match trigger, rounded combat-style hammer. Beveled magazine well. Manual thumb, grip and firing pin lock safeties. Solid barrel bushing. Contact maker for full details. Introduced 1990. Made in Canada by Para-Ordnance.

**Price:** Steel frame ..... \$795.00

**Price:** Alloy frame ..... \$765.00

**Price:** Stainless steel ..... \$865.00

## Para-Ordnance Limited Pistols

Similar to the P-Series pistols except with full-length recoil guide system; fully adjustable rear sight; tuned trigger with overtravel stop; beavertail grip safety; competition hammer; front and rear slide serrations; ambidextrous safety; lowered ejection port; ramped match-grade barrel; dove-tailed front sight. Introduced 1998. Made in Canada by Para-Ordnance.

**Price:** 9mm, 40 S&W, 45 ACP ..... \$945.00 to \$999.00

## Para-Ordnance LDA Auto Pistols

Similar to P-series except has double-action trigger mechanism. Steel frame with matte black finish, checkered composition grips. Available in 9mm Para., 40 S&W, 45 ACP. Introduced 1999. Made in Canada by Para-Ordnance.

**Price:** ..... \$775.00

# HANDGUNS — AUTOLOADERS, SERVICE & SPORT



**Para-Ordnance C5  
45 LDA Para Carry**



**Para-Ordnance C7  
45 LDA Para Companion**



**Peters Stahl High Capacity**



**Peters Stahl Trophy Master**



**Peters Stahl  
Millennium**



**Phoenix  
Arms HP22**

## Para-Ordnance LDA Limited Pistols

Similar to LDA, has ambidextrous safety, adjustable rear sight, front slide serrations and full-length recoil guide system. Made in Canada by Para-Ordnance.

**Price:** Black finish . . . . . \$975.00

**Price:** Stainless . . . . . \$1,049.00

## PARA-ORDNANCE C5 45 LDA PARA CARRY

**Caliber:** 45 ACP. **Barrel:** 3", 6+1 shot. **Weight:** 30 oz. **Length:** 6.5". **Grips:** Double diamond checkered Cocobolo. **Features:** Stainless finish and receiver, "world's smallest DAO 45 auto." Para LDA trigger system and safeties.

**Price:** . . . . . \$899.00

## PARA-ORDNANCE C7 45 LDA PARA COMPANION

**Caliber:** 45 ACP. **Barrel:** 3.5", 7+1 shot. **Weight:** 32 oz. **Length:** 7". **Grips:** Double diamond checkered Cocobolo. **Features:** Para LDA trigger system with Para LDA 3 safeties (slide lock, firing pin block and grip safety). Lightning speed, full size capacity.

**Price:** . . . . . \$899.00

## PETERS STAHL AUTOLOADING PISTOLS

**Caliber:** 9mm Para., 45 ACP. **Barrel:** 5" or 6". **Grips:** Walnut or walnut with rubber wrap. **Sights:** Fully adjustable rear, blade front. **Features:** Stainless steel extended slide stop, safety and extended magazine release button; speed trigger with stop and approx. 3-lb. pull; polished ramp. Introduced 2000. Imported from Germany by Phillips & Rogers.

**Price:** High Capacity (accepts 15-shot magazines in 45 cal.; includes 10-shot magazine) . . . . . \$1,695.00

**Price:** Trophy Master (blued or stainless, 7-shot in 45, 8-shot in 9mm) . . . . . \$1,995.00

**Price:** Millennium Model (titanium coating on receiver and slide) \$2,195.00

## PHOENIX ARMS HP22, HP25 AUTO PISTOLS

**Caliber:** 22 LR, 10-shot (HP22), 25 ACP, 10-shot (HP25). **Barrel:** 3". **Weight:** 20 oz. **Length:** 5-1/2" overall. **Grips:** Checkered composition. **Sights:** Blade front, adjustable rear. **Features:** Single action, exposed hammer; manual hold-open; button magazine release. Available in satin nickel, polished blue finish. Introduced 1993. Made in U.S.A. by Phoenix Arms.



**Rock River Standard Match**

**Price:** With gun lock and cable lanyard . . . . . \$130.00

**Price:** HP Rangemaster kit with 5" bbl., locking case and accessories . . . . . \$171.00

**Price:** HP Deluxe Rangemaster kit with 3" and 5" bbls., 2 mags., case . . . . . \$210.00

## ROCK RIVER ARMS STANDARD MATCH AUTO PISTOL

**Caliber:** 45 ACP. **Barrel:** NA. **Weight:** NA. **Length:** NA. **Grips:** Cocobolo, checkered. **Sights:** Heine fixed rear, blade front. **Features:** Chrome-moly steel frame and slide; beavertail grip safety with raised pad; checkered slide stop; ambidextrous safety; polished feed ramp and extractor; aluminum speed trigger with 3.5 lb. pull. Made in U.S.A. From Rock River Arms.

**Price:** . . . . . \$1,025.00

## ROCKY MOUNTAIN ARMS PATRIOT PISTOL

**Caliber:** 223, 10-shot magazine. **Barrel:** 7", with muzzle brake. **Weight:** 5 lbs. **Length:** 20.5" overall. **Grips:** Black composition. **Sights:** None furnished. **Features:** Milled upper receiver with enhanced Weaver base; milled lower receiver from billet plate; machined aluminum National Match handguard. Finished in DuPont Teflon-S matte black or NATO green. Comes with black nylon case, one magazine. Introduced 1993. From Rocky Mountain Arms, Inc.

**Price:** With A-2 handle top . . . . . \$2,500.00 to \$2,800.00

**Price:** Flat top model . . . . . \$3,000.00 to \$3,500.00



# HANDGUNS — AUTOLOADERS, SERVICE & SPORT



Ruger P89



Ruger P90



Ruger P93D



Ruger KP94D



Ruger KP95DAO

## RUGER P89 AUTOLOADING PISTOL

**Caliber:** 9mm Para., 10-shot magazine. **Barrel:** 4.50". **Weight:** 32 oz. **Length:** 7.84" overall. **Grips:** Grooved black synthetic composition. **Sights:** Square post front, square notch rear adjustable for windage, both with white dot inserts. **Features:** Double action, ambidextrous slide-mounted safety-levers. Slide 4140 chrome-moly steel or 400-series stainless steel, frame lightweight aluminum alloy. Ambidextrous magazine release. Blue, stainless steel. Introduced 1986; stainless 1990.

**Price:** P89, blue, extra mag and mag loader, plastic case locks . . . \$475.00  
**Price:** KP89, stainless, extra mag and mag loader, plastic case locks . . . \$525.00

## Ruger P89D Decocker Autoloading Pistol

Similar to standard P89 except has ambidextrous decocking levers in place of regular slide-mounted safety. Decocking levers move firing pin inside slide where hammer cannot reach, while simultaneously blocking firing pin from forward movement, allows shooter to decock cocked pistol without manipulating trigger. Conventional thumb decocking procedures are therefore unnecessary. Blue, stainless steel. Introduced 1990.

**Price:** P89D, blue, extra mag and mag loader, plastic case locks \$475.00  
**Price:** KP89D, stainless, extra mag and mag loader, plastic case locks . . . \$525.00

## Ruger P89 Double-Action-Only Autoloading Pistol

Same as KP89 except operates only in double-action mode. Has spurless hammer, gripping grooves on each side of rear slide; no external safety or decocking lever. Internal safety prevents forward movement of firing pin unless trigger is pulled. Available 9mm Para., stainless steel only. Introduced 1991.

**Price:** Lockable case, extra mag and mag loader. . . . . \$525.00

## RUGER P90 MANUAL SAFETY MODEL AUTOLOADING PISTOL

**Caliber:** 45 ACP, 8-shot magazine. **Barrel:** 4.50". **Weight:** 33.5 oz. **Length:** 7.75" overall. **Grips:** Grooved black synthetic composition. **Sights:** Square post front, square notch rear adjustable for windage, both with white dot. **Features:** Double action ambidextrous slide-mounted safety-levers move firing pin inside slide where hammer can not reach, simultaneously blocking firing pin from forward movement. Stainless steel only. Introduced 1991.

**Price:** KP90 with extra mag, loader, case and gunlock. . . . . \$565.00  
**Price:** P90 (blue) . . . . . \$525.00

## Ruger KP90 Decocker Autoloading Pistol

Similar to the P90 except has a manual decocking system. The ambidextrous decocking levers move the firing pin inside the slide where the hammer cannot reach it, while simultaneously blocking the firing pin from forward movement, allows shooter to decock a cocked pistol without manipulating the trigger. Available only in stainless steel. Overall length 7.75", weighs 33.5 oz. Introduced 1991.

**Price:** KP90D with case, extra mag and mag loading tool . . . . . \$565.00

## RUGER P93 COMPACT AUTOLOADING PISTOL

**Caliber:** 9mm Para., 10-shot magazine. **Barrel:** 3.9". **Weight:** 31 oz. **Length:** 7.25" overall. **Grips:** Grooved black synthetic composition. **Sights:** Square post front, square notch rear adjustable for windage. **Features:** Front of slide crowned with convex curve; slide has seven finger grooves; trigger guard bow higher for better grip; 400-series stainless slide, lightweight alloy frame; also blue. Decocker-only or DAO-only. Includes hard case and lock. Introduced 1993. Made in U.S.A. by Sturm, Ruger & Co.

**Price:** KP93DAO, double-action-only . . . . . \$575.00  
**Price:** KP93D ambidextrous decocker, stainless . . . . . \$575.00  
**Price:** P93D, ambidextrous decocker, blue . . . . . \$495.00

## Ruger KP94 Autoloading Pistol

Sized midway between full-size P-Series and compact P93. 4.25" barrel, 7.5" overall length, weighs about 33 oz. KP94 manual safety model; KP94DAO double-action-only (both 9mm Para., 10-shot magazine); KP94D is decocker-only in 40-caliber with 10-shot magazine. Slide gripping grooves roll over top of slide. KP94 has ambidextrous safety levers; KP94DAO has no external safety, full-cock hammer position or decocking lever; KP94D has ambidextrous decocking levers. Matte finish stainless slide, barrel, alloy frame. Also blue. Includes hard case and lock. Introduced 1994. Made in U.S.A. by Sturm, Ruger & Co.

**Price:** P94, P944, blue (manual safety) . . . . . \$495.00  
**Price:** KP94 (9mm), KP944 (40-caliber) (manual safety-stainless) . . . . . \$575.00  
**Price:** KP94DAO (9mm), KP944DAO (40-caliber) . . . . . \$575.00  
**Price:** KP94D (9mm), KP944D (40-caliber)-decock only . . . . . \$575.00

# HANDGUNS — AUTOLOADERS, SERVICE & SPORT



Ruger KP512



SIG-Sauer P220

SIG-Sauer P245 Compact



## RUGER P95 AUTOLOADING PISTOL

**Caliber:** 9mm Para., 10-shot magazine. **Barrel:** 3.9". **Weight:** 27 oz. **Length:** 7.25" overall. **Grips:** Grooved; integral with frame. **Sights:** Blade front, rear drift adjustable for windage; three-dot system. **Features:** Moulded polymer grip frame, stainless steel or chrome-moly slide. Suitable for +P+ ammunition. Safety model, decocker or DAO. Introduced 1996. Made in U.S.A. by Sturm, Ruger & Co. Comes with lockable plastic case, spare magazine, loader and lock.

**Price:** P95 DAO double-action-only ..... \$425.00

**Price:** P95D decocker only ..... \$425.00

**Price:** KP95D stainless steel decocker only ..... \$475.00

**Price:** KP95DAO double-action only, stainless steel ..... \$475.00

**Price:** KP95 safety model, stainless steel ..... \$475.00

**Price:** P95 safety model, blued finish ..... \$425.00

## RUGER P97 AUTOLOADING PISTOL

**Caliber:** 45 ACP 8-shot magazine. **Barrel:** 4-1/8". **Weight:** 30-1/2 oz. **Length:** 7-1/4" overall. **Grips:** Integral with frame. **Sights:** Blade front, rear drift adjustable for windage; three dot system. **Features:** Moulded polymer grip frame, stainless steel slide. Decocker or DAO. Introduced 1997. Made in U.S.A. by Sturm, Ruger & Co. Comes with lockable plastic case, spare magazine, loading tool.

**Price:** KP97D decocker only ..... \$495.00

**Price:** KP97DAO double-action only ..... \$495.00

**Price:** P97D decocker only, blued ..... \$460.00

## SAFARI ARMS ENFORCER PISTOL

**Caliber:** 45 ACP, 6-shot magazine. **Barrel:** 3.8", stainless. **Weight:** 36 oz. **Length:** 7.3" overall. **Grips:** Smooth walnut with etched black widow spider logo. **Sights:** Ramped blade front, LPA adjustable rear. **Features:** Extended safety, extended slide release; Commander-style hammer; beavertail grip safety; throated, polished, tuned. Parkerized matte black or satin stainless steel finishes. Made in U.S.A. by Safari Arms.

**Price:** ..... \$630.00

## SAFARI ARMS GI SAFARI PISTOL

**Caliber:** 45 ACP, 7-shot magazine. **Barrel:** 5", 416 stainless. **Weight:** 39.9 oz. **Length:** 8.5" overall. **Grips:** Checkered walnut. **Sights:** G.I.-style blade front, drift-adjustable rear. **Features:** Beavertail grip safety; extended thumb safety and slide release; Commander-style hammer. Parkerized finish. Reintroduced 1996.

**Price:** ..... \$439.00

## SAFARI ARMS CARRIER PISTOL

**Caliber:** 45 ACP, 7-shot magazine. **Barrel:** 6", 416 stainless steel. **Weight:** 30 oz. **Length:** 9.5" overall. **Grips:** Wood. **Sights:** Ramped blade front, LPA adjustable rear. **Features:** Beavertail grip safety; extended controls; full-length recoil spring guide; Commander-style hammer. Throated, polished and tuned. Satin stainless steel finish. Introduced 1999. Made in U.S.A. by Safari Arms, Inc.

**Price:** ..... \$714.00

## SAFARI ARMS COHORT PISTOL

**Caliber:** 45 ACP, 7-shot magazine. **Barrel:** 3.8", 416 stainless. **Weight:** 37 oz. **Length:** 8.5" overall. **Grips:** Smooth walnut with laser-etched black widow logo. **Sights:** Ramped blade front, LPA adjustable rear. **Features:** Combines the Enforcer model, slide and MatchMaster frame. Beavertail grip safety; extended thumb safety and slide release; Commander-style hammer. Throated, polished and tuned. Satin stainless finish. Introduced 1996. Made in U.S.A. by Safari Arms, Inc.

**Price:** ..... \$654.00

## SAFARI ARMS MATCHMASTER PISTOL

**Caliber:** 45 ACP, 7-shot. **Barrel:** 5" or 6", 416 stainless steel. **Weight:** 38 oz. (5" barrel). **Length:** 8.5" overall. **Grips:** Smooth walnut. **Sights:** Ramped blade, LPA adjustable rear. **Features:** Beavertail grip safety; extended controls; Commander-style hammer; throated, polished, tuned. Parkerized matte-black or satin stainless steel. Made in U.S.A. by Olympic Arms, Inc.

**Price:** 5" barrel ..... \$594.00

**Price:** 6" barrel ..... \$654.00

## Safari Arms Carry Comp Pistol

Similar to the Matchmaster except has Wil Schueman-designed hybrid compensator system. Made in U.S.A. by Olympic Arms, Inc.

**Price:** ..... \$1,067.00

## SEECAMP LWS 32 STAINLESS DA AUTO

**Caliber:** 32 ACP Win. Silvertip, 6-shot magazine. **Barrel:** 2", integral with frame. **Weight:** 10.5 oz. **Length:** 4-1/8" overall. **Grips:** Glass-filled nylon. **Sights:** Smooth, no-slug, contoured slide and barrel top. **Features:** Aircraft quality 17-4 PH stainless steel. Inertia-operated firing pin. Hammer fired double-action-only. Hammer automatically follows slide down to safety rest position after each shot, no manual safety needed. Magazine safety disconnect. Polished stainless. Introduced 1985. From L.W. Seecamp.

**Price:** ..... \$425.00

## SEMMERLING LM-4 SLIDE-ACTION PISTOL

**Caliber:** 45 ACP, 4-shot magazine. **Barrel:** 2". **Weight:** 24 oz. **Length:** NA. **Grips:** NA. **Sights:** NA. **Features:** While outwardly appearing to be a semi-automatic, the Semmerling LM-4 is a unique and super compact pistol employing a thumb activated slide mechanism (the slide is manually retracted between shots). Hand-built and super reliable, it is intended for professionals in law enforcement and for concealed carry by licensed and firearms-knowledgeable private citizens. From American Derringer Corp.

**Price:** ..... \$2,635.00

## SIG-SAUER P220 SERVICE AUTO PISTOL

**Caliber:** 45 ACP, (7- or 8-shot magazine). **Barrel:** 4-3/8". **Weight:** 27.8 oz. **Length:** 7.8" overall. **Grips:** Checkered black plastic. **Sights:** Blade front, drift adjustable rear for windage. Optional Siglite nightsights. **Features:** Double action. Decocking lever permits lowering hammer onto locked firing pin. Squared combat-type trigger guard. Slide stays open after last shot. Imported from Germany by SIGARMS, Inc.



# HANDGUNS — AUTOLOADERS, SERVICE & SPORT



SIG-Sauer Pro 2009



SIG-Sauer P229 Sport



SIG-Sauer P232

- Price: Blue SA/DA or DAO ..... \$790.00
- Price: Blue, Siglite night sights ..... \$880.00
- Price: K-Kote or nickel slide ..... \$830.00
- Price: K-Kote or nickel slide with Siglite night sights ..... \$930.00

### SIG-Sauer P220 Sport Auto Pistol

Similar to the P220 except has 4.9" barrel, ported compensator, all-stainless steel frame and slide, factory-tuned trigger, adjustable sights, extended competition controls. Overall length is 9.9", weighs 43.5 oz. Introduced 1999. From SIGARMS, Inc.

- Price: ..... \$1,320.00

### SIG-Sauer P245 Compact Auto Pistol

Similar to the P220 except has 3.9" barrel, shorter grip, 6-shot magazine, 7.28" overall length, and weighs 27.5 oz. Introduced 1999. From SIGARMS, Inc.

- Price: Blue ..... \$780.00
- Price: Blue, with Siglite sights ..... \$850.00
- Price: Two-tone ..... \$830.00
- Price: Two-tone with Siglite sights ..... \$930.00
- Price: With K-Kote finish ..... \$830.00
- Price: K-Kote with Siglite sights ..... \$930.00

### SIG-Sauer P229 DA Auto Pistol

Similar to the P228 except chambered for 9mm Para., 40 S&W, 357 SIG. Has 3.86" barrel, 7.08" overall length and 3.35" height. Weighs 30.5 oz. Introduced 1991. Frame made in Germany, stainless steel slide assembly made in U.S.; pistol assembled in U.S. From SIGARMS, Inc.

- Price: ..... \$795.00
- Price: With nickel slide ..... \$890.00
- Price: Nickel slide Siglite night sights ..... \$935.00

### SIG PRO AUTO PISTOL

**Caliber:** 9mm Para., 40 S&W, 10-shot magazine. **Barrel:** 3.86". **Weight:** 27.2 oz. **Length:** 7.36" overall. **Grips:** Composite and rubberized one-piece. **Sights:** Blade front, rear adjustable for windage. Optional Siglite night sights. **Features:** Polymer frame, stainless steel slide; integral frame accessory rail; replaceable steel frame rails; left- or right-handed magazine release. Introduced 1999. From SIGARMS, Inc.

- Price: SP2340 (40 S&W) ..... \$596.00
- Price: SP2009 (9mm Para.) ..... \$596.00
- Price: As above with Siglite night sights ..... \$655.00

### SIG-Sauer P226 Service Pistol

Similar to the P220 pistol except has 4.4" barrel, and weighs 28.3 oz. 357 SIG or 40 S&W. Imported from Germany by SIGARMS, Inc.

- Price: Blue SA/DA or DAO ..... \$830.00
- Price: With Siglite night sights ..... \$930.00
- Price: Blue, SA/DA or DAO 357 SIG ..... \$830.00
- Price: With Siglite night sights ..... \$930.00
- Price: K-Kote finish, 40 S&W only or nickel slide ..... \$830.00
- Price: K-Kote or nickel slide Siglite night sights ..... \$930.00
- Price: Nickel slide 357 SIG ..... \$875.00
- Price: Nickel slide, Siglite night sights ..... \$930.00

### Smith & Wesson 457 TDA



### SIG-Sauer P229 Sport Auto Pistol

Similar to the P229 except available in 357 SIG only; 4.8" heavy barrel; 8.6" overall length; weighs 40.6 oz.; vented compensator; adjustable target sights; rubber grips; extended slide latch and magazine release. Made of stainless steel. Introduced 1998. From SIGARMS, Inc.

- Price: ..... \$1,320.00

### SIG-SAUER P232 PERSONAL SIZE PISTOL

**Caliber:** 380 ACP, 7-shot. **Barrel:** 3-3/4". **Weight:** 16 oz. **Length:** 6-1/2" overall. **Grips:** Checkered black composite. **Sights:** Blade front, rear adjustable for windage. **Features:** Double action/single action or DAO. Blow-back operation, stationary barrel. Introduced 1997. Imported from Germany by SIGARMS, Inc.

- Price: Blue SA/DA or DAO ..... \$505.00
- Price: In stainless steel ..... \$545.00
- Price: With stainless steel slide, blue frame ..... \$525.00
- Price: Stainless steel, Siglite night sights, Hogue grips ..... \$585.00

### SIG-SAUER P239 PISTOL

**Caliber:** 9mm Para., 8-shot, 357 SIG 40 S&W, 7-shot magazine. **Barrel:** 3.6". **Weight:** 25.2 oz. **Length:** 6.6" overall. **Grips:** Checkered black composite. **Sights:** Blade front, rear adjustable for windage. Optional Siglite night sights. **Features:** SA/DA or DAO; blackened stainless steel slide, aluminum alloy frame. Introduced 1996. Made in U.S.A. by SIGARMS, Inc.

- Price: SA/DA or DAO ..... \$620.00
- Price: SA/DA or DAO with Siglite night sights ..... \$720.00
- Price: Two-tone finish ..... \$665.00
- Price: Two-tone finish, Siglite sights ..... \$765.00

### SMITH & WESSON MODEL 22A SPORT PISTOL

**Caliber:** 22 LR, 10-shot magazine. **Barrel:** 4", 5-1/2", 7". **Weight:** 29 oz. **Length:** 8" overall. **Grips:** Two-piece polymer. **Sights:** Patridge front, fully adjustable rear. **Features:** Comes with a sight bridge with Weaver-style integral optics mount; alloy frame; .312" serrated trigger; stainless steel slide and barrel with matte blue finish. Introduced 1997. Made in U.S.A. by Smith & Wesson.

- Price: 4" ..... \$264.00
- Price: 5-1/2" ..... \$292.00
- Price: 7" ..... \$331.00

### SMITH & WESSON MODEL 457 TDA AUTO PISTOL

**Caliber:** 45 ACP, 7-shot magazine. **Barrel:** 3-3/4". **Weight:** 29 oz. **Length:** 7-1/4" overall. **Grips:** One-piece Xenoy, wrap-around with straight back-strap. **Sights:** Post front, fixed rear, three-dot system. **Features:** Aluminum alloy frame, matte blue carbon steel slide; bobbed hammer; smooth trigger. Introduced 1996. Made in U.S.A. by Smith & Wesson.

- Price: ..... \$591.00

# HANDGUNS — AUTOLOADERS, SERVICE & SPORT



**Smith & Wesson 908**



**Smith & Wesson 4013 TSW**



**Smith & Wesson 410 DA**



**Smith & Wesson 910 DA**



**Smith & Wesson 3913 LadySmith**

## SMITH & WESSON MODEL 908 AUTO PISTOL

**Caliber:** 9mm Para., 8-shot magazine. **Barrel:** 3-1/2". **Weight:** 26 oz. **Length:** 6-13/16". **Grips:** One-piece Xenoy, wrap-around with straight backstrap. **Sights:** Post front, fixed rear, three-dot system. **Features:** Aluminum alloy frame, matte blue carbon steel slide; bobbed hammer; smooth trigger. Introduced 1996. Made in U.S.A. by Smith & Wesson.  
**Price:** ..... \$535.00

## SMITH & WESSON MODEL 4013, 4053 TSW AUTOS

**Caliber:** 40 S&W, 9-shot magazine. **Barrel:** 3-1/2". **Weight:** 26.4 oz. **Length:** 6-7/8" overall. **Grips:** Xenoy one-piece wrap-around. **Sights:** Novak three-dot system. **Features:** Traditional double-action system; stainless slide, alloy frame; fixed barrel bushing; ambidextrous decocker; reversible magazine catch, equipment rail. Introduced 1997. Made in U.S.A. by Smith & Wesson.  
**Price:** Model 4013 TSW ..... \$886.00  
**Price:** Model 4053 TSW, double-action-only ..... \$886.00

## SMITH & WESSON MODEL 22S SPORT PISTOLS

Similar to the Model 22A Sport except with stainless steel frame. Available only with 5-1/2" or 7" barrel. Introduced 1997. Made in U.S.A. by Smith & Wesson.  
**Price:** 5-1/2" standard barrel ..... \$358.00  
**Price:** 5-1/2" bull barrel, wood target stocks with thumbrest . . . . \$434.00  
**Price:** 7" standard barrel . . . . . \$395.00  
**Price:** 5-1/2" bull barrel, two-piece target stocks with thumbrest . \$353.00

## SMITH & WESSON MODEL 410 DA AUTO PISTOL

**Caliber:** 40 S&W, 10-shot magazine. **Barrel:** 4". **Weight:** 28.5 oz. **Length:** 7.5 oz. **Grips:** One-piece Xenoy, wrap-around with straight backstrap. **Sights:** Post front, fixed rear; three-dot system. **Features:** Aluminum alloy frame; blued carbon steel slide; traditional double action with left-side slide-mounted decocking lever. Introduced 1996. Made in U.S.A. by Smith & Wesson.  
**Price:** Model 410 ..... \$591.00  
**Price:** Model 410, HiViz front sight ..... \$612.00

## SMITH & WESSON MODEL 910 DA AUTO PISTOL

**Caliber:** 9mm Para., 10-shot magazine. **Barrel:** 4". **Weight:** 28 oz. **Length:** 7-3/8" overall. **Grips:** One-piece Xenoy, wrap-around with straight back-

strap. **Sights:** Post front with white dot, fixed two-dot rear. **Features:** Alloy frame, blue carbon steel slide. Slide-mounted decocking lever. Introduced 1995.

**Price:** Model 910 ..... \$535.00  
**Price:** Model 410, HiViz front sight ..... \$535.00

## SMITH & WESSON MODEL 3913 TRADITIONAL DOUBLE ACTION

**Caliber:** 9mm Para., 8-shot magazine. **Barrel:** 3-1/2". **Weight:** 26 oz. **Length:** 6-13/16" overall. **Grips:** One-piece Delrin wrap-around, textured surface. **Sights:** Post front with white dot, Novak LoMount Carry with two dots. **Features:** Aluminum alloy frame, stainless slide (M3913) or blue steel slide (M3914). Bobbed hammer with no half-cock notch; smooth .304" trigger with rounded edges. Straight backstrap. Equipment rail. Extra magazine included. Introduced 1989.  
**Price:** ..... \$760.00

## Smith & Wesson Model 3913-LS Ladysmith Auto

Similar to the standard Model 3913 except has frame that is upswept at the front, rounded trigger guard. Comes in frosted stainless steel with matching gray grips. Grips are ergonomically correct for a woman's hand. Novak LoMount Carry rear sight adjustable for windage, smooth edges for snag resistance. Extra magazine included. Introduced 1990.  
**Price:** ..... \$782.00

## Smith & Wesson Model 3953 DAO Pistol

Same as the Model 3913 except double-action-only. Model 3953 has stainless slide with alloy frame. Overall length 7"; weighs 25.5 oz. Extra magazine included. Equipment rail. Introduced 1990.  
**Price:** ..... \$760.00

## Smith & Wesson Model 3913TSW/3953TSW Auto Pistols

Similar to the Model 3913 and 3953 except TSW guns have tighter tolerances, ambidextrous manual safety/decocking lever, flush-fit magazine, delayed-unlock firing system; magazine disconnect. Compact alloy frame, stainless steel slide. Straight backstrap. Introduced 1998. Made in U.S.A. by Smith & Wesson.  
**Price:** Single action/double action ..... \$760.00  
**Price:** Double action only ..... \$760.00



# HANDGUNS — AUTOLOADERS, SERVICE & SPORT



Smith & Wesson 4006



Smith & Wesson  
4566 TSW



Smith & Wesson  
Sigma SW40V

## SMITH & WESSON MODEL 4006 TDA AUTO

**Caliber:** 40 S&W, 10-shot magazine. **Barrel:** 4". **Weight:** 38.5 oz. **Length:** 7-7/8" overall. **Grips:** Xenoy wrap-around with checkered panels. **Sights:** Replaceable post front with white dot, Novak LoMount Carry fixed rear with two white dots, or micro. click adjustable rear with two white dots. **Features:** Stainless steel construction with non-reflective finish. Straight backstrap, quipment rail. Extra magazine included. Introduced 1990.

**Price:** With adjustable sights. . . . . \$944.00  
**Price:** With fixed sight . . . . . \$907.00  
**Price:** With fixed night sights. . . . . \$1,040.00  
**Price:** With Saf-T-Trigger, fixed sights . . . . . \$927.00

## SMITH & WESSON MODEL 4006 TSW

**Caliber:** 40, 10-shot. **Barrel:** 4". **Grips:** Straight back strap grip. **Sights:** Fixed Novak LoMount Carry. **Features:** Traditional double action, ambidextrous safety, Saf-T-Trigger, equipment rail, satin stainless.

**Price:** . . . . . \$927.00

## Smith & Wesson Model 4043, 4046 DA Pistols

Similar to the Model 4006 except is double-action-only. Has a semi-bobbed hammer, smooth trigger, 4" barrel; Novak LoMount Carry rear sight, post front with white dot. Overall length is 7-1/2", weighs 28 oz. Model 4043 has alloy frame, equipment rail. Extra magazine included. Introduced 1991.

**Price:** Model 4043 (alloy frame) . . . . . \$886.00  
**Price:** Model 4046 (stainless frame) . . . . . \$907.00  
**Price:** Model 4046 with fixed night sights . . . . . \$1,040.00

## SMITH & WESSON MODEL 4500 SERIES AUTOS

**Caliber:** 45 ACP, 8-shot magazine. **Barrel:** 5" (M4506). **Weight:** 41 oz. (4506). **Length:** 8-1/2" overall. **Grips:** Xenoy one-piece wrap-around, arched or straight backstrap. **Sights:** Post front with white dot, adjustable or fixed Novak LoMount Carry on M4506. **Features:** M4506 has serrated hammer spur, equipment rail. All have two magazines. Contact Smith & Wesson for complete data. Introduced 1989.

**Price:** Model 4566 (stainless, 4-1/4", traditional DA, ambidextrous safety, fixed sight) . . . . . \$942.00  
**Price:** Model 4586 (stainless, 4-1/4", DA only) . . . . . \$942.00  
**Price:** Model 4566 (stainless, 4-1/4" with Saf-T-Trigger, fixed sight) . . . . . \$961.00

## SMITH & WESSON MODEL 4513TSW/4553TSW PISTOLS

**Caliber:** 45 ACP, 7-shot magazine. **Barrel:** 3-3/4". **Weight:** 28 oz. (M4513TSW). **Length:** 6-7/8" overall. **Grips:** Checkered Xenoy; straight backstrap. **Sights:** White dot front, Novak LoMount Carry 2-Dot rear. **Features:** Model 4513TSW is traditional double action, Model 4553TSW is double action only. TSW series has tighter tolerances, ambidextrous manual safety/decocking lever, flush-fit magazine, delayed-unlock firing system; magazine disconnect. Compact alloy frame, stainless steel slide, equipment rail. Introduced 1998. Made in U.S.A. by Smith & Wesson.

**Price:** Model 4513TSW. . . . . \$924.00  
**Price:** Model 4553TSW. . . . . \$924.00

## SMITH & WESSON MODEL 4566 TSW

**Caliber:** 45 ACP. **Barrel:** 4-1/4", 8-shot . **Grips:** Straight back strap grip. **Sights:** Fixed Novak LoMount Carry. **Features:** Ambidextrous safety, equipment rail, Saf-T-Trigger, satin stainless finish. Traditional double action.

**Price:** . . . . . \$961.00

## SMITH & WESSON MODEL 5900 SERIES AUTO PISTOLS

**Caliber:** 9mm Para., 10-shot magazine. **Barrel:** 4". **Weight:** 28-1/2 to 37-1/2 oz. (fixed sight); 38 oz. (adjustable sight). **Length:** 7-1/2" overall. **Grips:** Xenoy wrap-around with curved backstrap. **Sights:** Post front with white dot, fixed or fully adjustable with two white dots. **Features:** All stainless, stainless and alloy or carbon steel and alloy construction. Smooth .304" trigger, .260" serrated hammer. Equipment rail. Introduced 1989.

**Price:** Model 5906 (stainless, traditional DA, adjustable sight, ambidextrous safety) . . . . . \$904.00  
**Price:** As above, fixed sight. . . . . \$841.00  
**Price:** With fixed night sights. . . . . \$995.00  
**Price:** With Saf-T-Trigger. . . . . \$882.00  
**Price:** Model 5946 DAO (as above, stainless frame and slide) . . . \$863.00

## SMITH & WESSON ENHANCED SIGMA SERIES DAO PISTOLS

**Caliber:** 9mm Para., 40 S&W, 10-shot magazine. **Barrel:** 4". **Weight:** 26 oz. **Length:** 7.4" overall. **Grips:** Integral. **Sights:** White dot front, fixed rear; three-dot system. Tritium night sights available. **Features:** Ergonomic polymer frame; low barrel centerline; internal striker firing system; corrosion-resistant slide; Teflon-filled, electroless-nickel coated magazine, equipment rail. Introduced 1994. Made in U.S.A. by Smith & Wesson.

**Price:** SW9E, 9mm, 4" barrel, black finish, fixed sights . . . . . \$447.00  
**Price:** SW9V, 9mm, 4" barrel, satin stainless, fixed night sights . . . \$447.00  
**Price:** SW9VE, 4" barrel, satin stainless, Saf-T-Trigger, fixed sights . . . . . \$466.00  
**Price:** SW40E, 40 S&W, 4" barrel, black finish, fixed sights . . . . \$657.00  
**Price:** SW40V, 40 S&W, 4" barrel, black polymer, fixed sights . . . \$447.00  
**Price:** SW40VE, 4" barrel, satin stainless, Saf-T-Trigger, fixed sights . . . . . \$466.00

# HANDGUNS — AUTOLOADERS, SERVICE & SPORT



Smith & Wesson 99



Springfield, Inc.  
1911A1 Standard



Springfield, Inc.  
Full-Size 1911A1



Springfield, Inc. TRP



Springfield, Inc.  
V-10 Ultra Compact

## SMITH & WESSON MODEL CS9 CHIEF'S SPECIAL AUTO

**Caliber:** 9mm Para., 7-shot magazine. **Barrel:** 3". **Weight:** 20.8 oz. **Length:** 6-1/4" overall. **Grips:** Hogue wrap-around rubber. **Sights:** White dot front, fixed two-dot rear. **Features:** Traditional double-action trigger mechanism. Alloy frame, stainless or blued slide. Ambidextrous safety. Introduced 1999. Made in U.S.A. by Smith & Wesson.

**Price:** Blue or stainless . . . . . \$680.00

## Smith & Wesson Model CS40 Chief's Special Auto

Similar to CS9, chambered for 40 S&W (7-shot magazine), 3-1/4" barrel, weighs 24.2 oz., measures 6-1/2" overall. Introduced 1999. Made in U.S.A. by Smith & Wesson.

**Price:** Blue or stainless . . . . . \$717.00

## Smith & Wesson Model CS45 Chief's Special Auto

Similar to CS40, chambered for 45 ACP, 6-shot magazine, weighs 23.9 oz. Introduced 1999. Made in U.S.A. by Smith & Wesson.

**Price:** Blue or stainless . . . . . \$717.00

## SMITH & WESSON MODEL 99

**Caliber:** 9mm Para. 4" barrel; 40 S&W 4-1/8" barrel; 10-shot, adj. sights. **Features:** Traditional double action satin stainless, black polymer frame, equipment rail, Saf-T-Trigger.

**Price:** 4" barrel . . . . . \$648.00

**Price:** 4-1/8" barrel . . . . . \$648.00

## SPRINGFIELD, INC. FULL-SIZE 1911A1 AUTO PISTOL

**Caliber:** 9mm Para., 9-shot; 38 Super, 9-shot; 40 S&W, 9-shot; 45 ACP, 7-shot. **Barrel:** 5". **Weight:** 35.6 oz. **Length:** 8-5/8" overall. **Grips:** Cocobolo. **Sights:** Fixed three-dot system. **Features:** Beveled magazine well; lowered and flared ejection port. All forged parts, including frame, barrel, slide. All new production. Introduced 1990. From Springfield, Inc.

**Price:** Mil-Spec 45 ACP, Parkerized . . . . . \$559.00

**Price:** Standard, 45 ACP, blued, Novak sights . . . . . \$824.00

**Price:** Standard, 45 ACP, stainless, Novak sights . . . . . \$828.00

**Price:** Lightweight 45 ACP (28.6 oz., matte finish, night sights) . . . . . \$877.00

**Price:** 40 S&W, stainless . . . . . \$860.00

**Price:** 9mm, stainless . . . . . \$837.00

## Springfield, Inc. TRP Pistols

Similar to 1911A1 except 45 ACP only, checkered front strap and main-spring housing, Novak Night Sight combat rear sight and matching dove-tailed front sight, tuned, polished extractor, oversize barrel link; lightweight speed trigger and combat action job, match barrel and bushing, extended ambidextrous thumb safety and fitted beavertail grip safety. Carry bevel on entire pistol; checkered cocobolo wood grips, comes with two Wilson 7-shot magazines. Frame is engraved "Tactical," both sides of frame with "TRP." Introduced 1998. From Springfield, Inc.

**Price:** Standard with Armory Kote finish . . . . . \$1,395.00

**Price:** Standard, stainless steel . . . . . \$1,370.00

**Price:** Standard with Operator Light Rail Armory Kote . . . . . \$1,473.00

## Springfield, Inc. 1911A1 High Capacity Pistol

Similar to Standard 1911A1, available in 45 ACP with 10-shot magazine. Commander-style hammer, walnut grips, beveled magazine well, plastic carrying case. Can accept higher-capacity Para-Ordnance magazines. Introduced 1993. From Springfield, Inc.

**Price:** Mil-Spec 45 ACP . . . . . \$756.00

**Price:** 45 ACP Ultra Compact (3-1/2" bbl.) . . . . . \$909.00

## Springfield, Inc. 1911A1 V-Series Ported Pistols

Similar to standard 1911A1, scalloped slides with 10, 12 or 16 matching barrel ports to redirect powder gasses and reduce recoil and muzzle flip. Adjustable rear sight, ambi thumb safety, Videki speed trigger, and beveled magazine well. Checkered walnut grips standard. Available in 45 ACP, stainless or bi-tone. Introduced 1992.

**Price:** V-16 Long Slide, stainless . . . . . \$1,121.00

**Price:** Target V-12, stainless . . . . . \$878.00

**Price:** V-10 (Ultra-Compact, bi-tone) . . . . . \$853.00

**Price:** V-10 stainless . . . . . \$863.00

## Springfield, Inc. 1911A1 Champion Pistol

Similar to standard 1911A1, slide is 4". Novak Night Sights. Delta hammer and cocobolo grips. Available in 45 ACP only; Parkerized or stainless. Introduced 1989.

**Price:** Stainless . . . . . \$849.00



# HANDGUNS — AUTOLOADERS, SERVICE & SPORT



Springfield, Inc.  
X-Treme Duty



Taurus PT 22



Taurus PT-911

## Springfield, Inc. Ultra Compact Pistol

Similar to 1911A1 Compact, shorter slide, 3.5" barrel, beavertail grip safety, beveled magazine well, Novak Low Mount or Novak Night Sights, Video speed trigger, flared ejection port, stainless steel frame, blued slide, match grade barrel, rubber grips. Introduced 1996. From Springfield, Inc.

**Price:** Parkerized 45 ACP, Night Sights . . . . . \$589.00

**Price:** Stainless 45 ACP, Night Sights . . . . . \$849.00

**Price:** Lightweight, 9mm, stainless . . . . . \$837.00

## Springfield, Inc. Compact Lightweight

Mates a Springfield Inc. Champion length slide with the shorter Ultra-Compact forged alloy frame for concealability. In 45 ACP.

**Price:** . . . . . \$733.00

## Springfield, Inc. Long Slide 1911 A1 Pistol

Similar to Full Size model, 6" barrel and slide for increased sight radius and higher velocity, fully adjustable sights, muzzle-forward weight distribution for reduced recoil and quicker shot-to-shot recovery. From Springfield Inc.

**Price:** Trophy, 45 ACP, stainless with Night Sights . . . . . \$1,049.00

**Price:** Target Match, stainless with adj. sights . . . . . \$1,452.00

**Price:** V-16 stainless steel . . . . . \$1,121.00

## SPRINGFIELD, INC. MICRO-COMPACT 1911A1 PISTOL

**Caliber:** 45 ACP, 40 S&W 6+1 capacity. **Barrel:** 3" 1:16 LH. **Weight:** 24 oz. **Length:** 5.7". **Sights:** Novak LoMount tritium. Dovetail front. **Features:** Forged frame and slide, ambi thumb safety, extreme carry bevel treatment, lockable plastic case, 2 magazines.

**Price:** . . . . . \$993.00 to \$1,021.00

## SPRINGFIELD, INC. X-TREME DUTY

**Caliber:** 9mm, 40 S&W, 357 Sig. **Barrel:** 4.08". **Weight:** 22.88 oz. **Length:** 7.2". **Sights:** Dovetail front and rear. **Features:** Lightweight, ultra high-impact polymer frame. Trigger, firing pin and grip safety. Two 10-rod steel easy glide magazines. Imported from Croatia.

**Price:** . . . . . \$489.00 to \$1,099.00

## STEYR M & S SERIES AUTO PISTOLS

**Caliber:** 9mm Para., 40 S&W, 357 SIG; 10-shot magazine. **Barrel:** 4" (3.58" for Model S). **Weight:** 28 oz. (22.5 oz. for Model S). **Length:** 7.05" overall (6.53" for Model S). **Grips:** Ultra-rigid polymer. **Sights:** Drift-adjustable, white-outline rear; white-triangle blade front. **Features:** Polymer frame; trigger-drop firing pin, manual and key-lock safeties; loaded chamber indicator; 5.5-lb. trigger pull; 111-degree grip angle enhances natural pointing. Introduced 2000. Imported from Austria by GSI Inc.

**Price:** Model M (full-sized frame with 4" barrel) . . . . . \$609.95

**Price:** Model S (compact frame with 3.58" barrel) . . . . . \$609.95

**Price:** Extra 10-shot magazines (Model M or S) . . . . . \$39.00

## TAURUS MODEL PT 22/PT 25 AUTO PISTOLS

**Caliber:** 22 LR, 8-shot (PT 22); 25 ACP, 9-shot (PT 25). **Barrel:** 2.75". **Weight:** 12.3 oz. **Length:** 5.25" overall. **Grips:** Smooth rosewood or mother-of-pearl. **Sights:** Fixed. **Features:** Double action. Tip-up barrel for

loading, cleaning. Blue, nickel, duotone or blue with gold accents. Introduced 1992. Made in U.S.A. by Taurus International.

**Price:** 22 LR, 25 ACP, blue, nickel or with duo-tone finish

with rosewood grips . . . . . \$219.00

**Price:** 22 LR, 25 ACP, blue with gold trim, rosewood grips. . . . . \$234.00

**Price:** 22 LR, 25 ACP, blue, nickel or duotone finish with checkered

wood grips. . . . . \$219.00

**Price:** 22 LR, 25 ACP, blue with gold trim, mother of pearl grips . . \$250.00

## TAURUS MODEL PT24/7

**Caliber:** 9mm, 10+1 shot; .40 Cal., 10+1 shot. **Barrel:** 4". **Weight:** 27.2 oz. **Length:** 7-18". **Grips:** RIBBER rubber-finned overlay on polymer. **Sights:** Adjustable. **Features:** Accessory rail, four safeties, blue or stainless finish, consistent trigger pull weight and travel. Introduced 2003. Imported from Brazil by Taurus International.

**Price:** 9mm . . . . . \$578.00

**Price:** .40 Cal. . . . . \$594.00

## TAURUS MODEL PT92 AUTO PISTOL

**Caliber:** 9mm Para., 10-shot mag. **Barrel:** 5". **Weight:** 34 oz. **Length:** 8.5" overall. **Grips:** Checkered rubber, rosewood, mother-of-pearl. **Sights:** Fixed notch rear. Three-dot sight system. Also offered with micrometric-click adjustable night sights. **Features:** Double action, ambidextrous 3-way hammer drop safety, allows cocked & locked carry. Blue, stainless steel, blue with gold highlights, stainless steel with gold highlights, forged aluminum frame, integral keylock. .22 LR conversion kit available. Imported from Brazil by Taurus International.

**Price:** Blue . . . . . \$578.00 to \$672.00

## Taurus Model PT99 Auto Pistol

Similar to PT92, fully adjustable rear sight.

**Price:** Blue . . . . . \$575.00 to \$670.00

**Price:** 22 Conversion kit for PT 92 and PT99 (includes barrel and slide) . . . . . \$266.00

## TAURUS MODEL PT-100/101 AUTO PISTOL

**Caliber:** 40 S&W, 10-shot mag. **Barrel:** 5". **Weight:** 34 oz. **Length:** 8-1/2". **Grips:** Checkered rubber, rosewood, mother-of-pearl. **Sights:** 3-dot fixed or adjustable; night sights available. **Features:** Single/double action with three-position safety/decocker. Re-introduced in 2001. Imported by Taurus International.

**Price:** PT100. . . . . \$578.00 to \$672.00

**Price:** PT101. . . . . \$594.00 to \$617.00

## TAURUS MODEL PT-111 MILLENNIUM PRO AUTO PISTOL

**Caliber:** 9mm Para., 10-shot mag. **Barrel:** 3.25". **Weight:** 18.7 oz. **Length:** 6-1/8" overall. **Grips:** Polymer. **Sights:** Three-dot fixed; night sights available. Low profile, three-dot combat. **Features:** Double action only, polymer frame, matte stainless or blue steel slide, manual safety, integral keylock. Deluxe models with wood grip inserts. Now issued in a third generation series with many cosmetic and internal improvements.

**Price:** . . . . . \$445.00 to \$539.00

# HANDGUNS — AUTOLOADERS, SERVICE & SPORT



Taurus PT-938



Taurus PT-940



Taurus PT-945



Taurus PT-957

## Taurus Model PT-111 Millennium Titanium Pistol

Similar to PT-111, titanium slide, night sights.

**Price:** ..... \$586.00

## TAURUS PT-132 MILLENNIUM PRO AUTO PISTOL

**Caliber:** 32 ACP, 10-shot mag. **Barrel:** 3.25". **Weight:** 18.7 oz. **Grips:** Polymer. **Sights:** 3-dot fixed; night sights available. **Features:** Double action only, polymer frame, matte stainless or blue steel slide, manual safety, integral keylock action. Introduced 2001.

**Price:** ..... \$445.00 to \$461.00

## TAURUS PT-138 MILLENNIUM PRO SERIES

**Caliber:** 380 ACP, 10-shot mag. **Barrel:** 3.25". **Weight:** 18.7 oz. **Grips:** Polymer. **Sights:** Fixed three-dot fixed. **Features:** Double action only, polymer frame, matte stainless or blue steel slide, manual safety, integral keylock.

**Price:** ..... \$445.00 to \$461.00

## TAURUS PT-140 MILLENNIUM PRO AUTO PISTOL

**Caliber:** 40 S&W, 10-shot mag. **Barrel:** 3.25". **Weight:** 18.7 oz. **Grips:** Checkered polymer. **Sights:** 3-dot fixed; night sights available. **Features:** Double-action-only; matte stainless or blue steel slide, black polymer frame, manual safety, integral keylock action. From Taurus International.

**Price:** ..... \$484.00 to \$578.00

## TAURUS PT-145 MILLENNIUM AUTO PISTOL

**Caliber:** 45 ACP, 10-shot mag. **Barrel:** 3.27". **Weight:** 23 oz. **Stock:** Checkered polymer. **Sights:** 3-dot fixed; night sights available. **Features:** Double-action only, matte stainless or blue steel slide, black polymer frame, manual safety, integral keylock. From Taurus International.

**Price:** ..... \$484.00 to \$578.00

## TAURUS MODEL PT-911 AUTO PISTOL

**Caliber:** 9mm Para., 10-shot mag. **Barrel:** 4". **Weight:** 28.2 oz. **Length:** 7" overall. **Grips:** Checkered rubber, rosewood, mother-of-pearl. **Sights:** Fixed, three-dot blue or stainless; night sights optional. **Features:** Double action, semi-auto ambidextrous three-way hammer drop safety, allows cocked and locked carry. Blue, stainless steel, blue with gold highlights, or stainless steel with gold highlights, forged aluminum frame, integral keylock.

**Price:** ..... \$523.00 to \$617.00

## TAURUS MODEL PT-938 AUTO PISTOL

**Caliber:** 380 ACP, 10-shot mag. **Barrel:** 3.72". **Weight:** 27 oz. **Length:** 6.5" overall. **Grips:** Checkered rubber. **Sights:** Fixed, three-dot. **Features:** Double action, ambidextrous three-way hammer drop allows cocked & locked carry. Forged aluminum frame. Integral keylock. Imported by Taurus International.

**Price:** Blue ..... \$516.00

**Price:** Stainless ..... \$531.00

## TAURUS MODEL PT-940 AUTO PISTOL

**Caliber:** 40 S&W, 10-shot mag. **Barrel:** 3-5/8". **Weight:** 28.2 oz. **Length:** 7" overall. **Grips:** Checkered rubber, rosewood or mother-of-pearl. **Sights:** Fixed, three-dot blue or stainless; night sights optional. **Features:** Double action, semi-auto ambidextrous three-way hammer drop safety, allows cocked & locked carry. Blue, stainless steel, blue with gold highlights, or stainless steel with gold highlights, forged aluminum frame, integral keylock.

**Price:** ..... \$523.00 to \$617.00

## TAURUS MODEL PT-945 SERIES

**Caliber:** 45 ACP, 8-shot mag. **Barrel:** 4.25". **Weight:** 28.2/29.5 oz. **Length:** 7.48" overall. **Grips:** Checkered rubber, rosewood or mother-of-pearl. **Sights:** Fixed, three-dot; night sights optional. **Features:** Double-action with ambidextrous three-way hammer drop safety allows cocked & locked carry. Forged aluminum frame, PT-945C has ported barrel/slide. Blue, stainless, blue with gold highlights, stainless with gold highlights, integral keylock. Introduced 1995. Imported by Taurus International.

**Price:** ..... \$563.00 to \$641.00

## TAURUS MODEL PT-957 AUTO PISTOL

**Caliber:** 357 SIG, 10-shot mag. **Barrel:** 4". **Weight:** 28 oz. **Length:** 7" overall. **Grips:** Checkered rubber, rosewood or mother-of-pearl. **Sights:** Fixed, three-dot blue or stainless; night sights optional. **Features:** Double action, blue, stainless steel, blue with gold accents or stainless with gold accents, ported barrel/slide, three-position safety with decocking lever and ambidextrous safety. Forged aluminum frame, integral keylock. Introduced 1999. Imported by Taurus International.

**Price:** ..... \$525.00 to \$620.00

**Price:** Non-ported ..... \$525.00 to \$535.00



# HANDGUNS — AUTOLOADERS, SERVICE & SPORT



Walther PPK/S



Walther PPK



Walther P99



Walther P22



Wilkinson Sherry

## TAURUS MODEL 922 SPORT PISTOL

**Caliber:** .22 LR, 10-shot magazine. **Barrel:** 6". **Weight:** 24.8 oz. **Length:** 9-1/8". **Grips:** Polymer. **Sights:** Adjustable. **Features:** Matte blue steel finish, machined target crown, polymer frame, single and double action, easy disassembly for cleaning.

**Price:** ..... (blue) \$310.00  
**Price:** ..... (stainless) \$328.00

## WALTHER PPK/S AMERICAN AUTO PISTOL

**Caliber:** 380 ACP, 7-shot magazine. **Barrel:** 3.27". **Weight:** 23-1/2 oz. **Length:** 6.1" overall. **Stocks:** Checkered plastic. **Sights:** Fixed, white markings. **Features:** Double action; manual safety blocks firing pin and drops hammer; chamber loaded indicator on 32 and 380; extra finger rest magazine provided. Made entirely in the United States. Introduced 1980.

**Price:** 380 ACP only, blue ..... \$540.00  
**Price:** As above, 32 ACP or 380 ACP, stainless ..... \$540.00

## Walther PPK American Auto Pistol

Similar to Walther PPK/S except weighs 21 oz., has 6-shot capacity. Made in the U.S. Introduced 1986.

**Price:** Stainless, 32 ACP or 380 ACP ..... \$540.00  
**Price:** Blue, 380 ACP only ..... \$540.00

## WALTHER P99 AUTO PISTOL

**Caliber:** 9mm Para., 9x21, 40 S&W, 10-shot magazine. **Barrel:** 4". **Weight:** 25 oz. **Length:** 7" overall. **Grips:** Textured polymer. **Sights:** Blade front (comes with three interchangeable blades for elevation adjustment), micrometer rear adjustable for windage. **Features:** Double-action mechanism with trigger safety, decock safety, internal striker safety; chamber loaded indicator; ambidextrous magazine release levers; polymer frame

with interchangeable backstrap inserts. Comes with two magazines. Introduced 1997. Imported from Germany by Carl Walther USA.

**Price:** ..... \$799.00

## Walther P990 Auto Pistol

Similar to the P99 except is double-action-only. Available in blue or silver tenifer finish. Introduced 1999. Imported from Germany by Carl Walther USA.

**Price:** ..... \$749.00

## WALTHER P22 PISTOL

**Caliber:** 22 LR. **Barrel:** 3.4", 5". **Weight:** 19.6 oz. (3.4"), 20.3 oz. (5"). **Length:** 6.26", 7.83". **Grips:** NA. **Sights:** Interchangeable white dot, front, two-dot adjustable, rear. **Features:** A rimfire version of the Walther P99 pistol, available in nickel slide with black frame, or green frame with black slide versions. Made in Germany and distributed in the U.S. by Smith & Wesson.

**Price:** ..... NA

## WILKINSON SHERRY AUTO PISTOL

**Caliber:** 22 LR, 8-shot magazine. **Barrel:** 2-1/8". **Weight:** 9-1/4 oz. **Length:** 4-3/8" overall. **Grips:** Checkered black plastic. **Sights:** Fixed, groove. **Features:** Cross-bolt safety locks the sear into the hammer. Available in all blue finish or blue slide and trigger with gold frame. Introduced 1985.

**Price:** ..... \$280.00

## WILKINSON LINDA AUTO PISTOL

**Caliber:** 9mm Para. **Barrel:** 8-5/16". **Weight:** 4 lbs., 13 oz. **Length:** 12-1/4" overall. **Grips:** Checkered black plastic pistol grip, walnut forend. **Sights:** Protected blade front, aperture rear. **Features:** Fires from closed bolt. Semi-auto only. Straight blowback action. Cross-bolt safety. Removable barrel. From Wilkinson Arms.

**Price:** ..... \$675.00

# HANDGUNS — DOUBLE ACTION REVOLVERS, SERVICE & SPORT

*Includes models suitable for hunting and competitive courses of fire, both police and international.*



Armscor M-200DC

## ARMSCOR M-200DC REVOLVER

**Caliber:** 38 Spec., 6-shot cylinder. **Barrel:** 2-1/2", 4". **Weight:** 22 oz. (2-1/2" barrel). **Length:** 7-3/8" overall (2-1/2" barrel). **Grips:** Checkered rubber.

**Sights:** Blade front, fixed notch rear. **Features:** All-steel construction; floating firing pin, transfer bar ignition; shrouded ejector rod; blue finish. Reintroduced 1996. Imported from the Philippines by K.B.I., Inc.

**Price:** 2-1/2" ..... \$199.99

**Price:** 4" ..... \$205.00

## ARMSPORT MODEL 4540 REVOLVER

**Caliber:** 38 Special. **Barrel:** 4". **Weight:** 32 oz. **Length:** 9" overall. **Sights:** Fixed rear, blade front. **Features:** Ventilated rib; blued finish. Imported from Argentina by Armsport Inc.

**Price:** ..... \$140.00

## COMANCHE I, II, III DA REVOLVERS

**Features:** Adjustable sights. Blue or stainless finish. Distributed by SGS Importers.

**Price:** I 22 LR, 6" bbl, 9-shot, blue ..... \$236.95

**Price:** I 22LR, 6" bbl, 9-shot, stainless ..... \$258.95

**Price:** II 38 Special, 3", 4" bbl, 6-shot, blue ..... \$219.95

**Price:** II 38 Special, 4" bbl, 6-shot, stainless ..... \$236.95

**Price:** III 357 Mag, 3", 4", 6" bbl, 6-shot, blue ..... \$253.95

**Price:** III 357 Mag, 3", 4", 6" bbl, 6-shot, stainless ..... \$274.95

**Price:** II 38 Special, 3" bbl, 6-shot, stainless steel ..... \$236.95

## DAN WESSON 722M SMALL FRAME REVOLVER

**Caliber:** 22 WMR. **Barrel:** 2-1/2", 4", 6", 8" or 10"; interchangeable. **Weight:** 36 oz. (2-1/2"), 44 oz. (6"). **Length:** 9-1/4" overall (4" barrel).

**Grips:** Hogue Gripper rubber (walnut, exotic woods optional). **Sights:** 1/8" serrated, interchangeable front, white outline rear adjustable for windage and elevation. **Features:** Built on the same frame as the Wesson 357; smooth, wide trigger with over-travel adjustment, wide spur hammer, with short double-action travel. Available in blue or stainless steel.

**Price:** Blued or stainless finish ..... \$643.00 to \$873.00

## DAN WESSON FIREARMS MODEL 15/715 and 32/732 REVOLVERS

**Caliber:** 32-20, 32 H&R Mag. (Model 32), 357 Mag. (Model 15). **Barrel:** 2-1/2", 4", 6", 8" (M32), 2-1/2", 4", 6", 8", 10" (M15); vent heavy. **Weight:** 36 oz. (2-1/2" barrel). **Length:** 9-1/4" overall (4" barrel). **Grips:** Checkered, interchangeable. **Sights:** 1/8" serrated front, fully adjustable rear. **Features:** New Generation Series. Interchangeable barrels; wide, smooth trigger, wide hammer spur; short double-action travel. Available in blue or stainless. Reintroduced 1997. Made in U.S.A. by Dan Wesson Firearms. Contact maker for full list of models.

**Price:** Model 15/715, 2-1/2" (blue or stainless) ..... \$551.00

**Price:** Model 15/715, 8" (blue or stainless) ..... \$612.00

**Price:** Model 15/715, compensated ..... \$704.00 to \$827.00

**Price:** Model 32/732, 4" (blue or stainless) ..... \$674.00

**Price:** Model 32/732, 8" (blue or stainless) ..... \$766.00



Comanche III

## DAN WESSON FIREARMS MODEL 41/741, 44/744 and 45/745 REVOLVERS

**Caliber:** 41 Mag., 44 Mag., 45 Colt, 6-shot. **Barrel:** 4", 6", 8", 10"; interchangeable; 4", 6", 8" Compensated. **Weight:** 48 oz. (4"). **Length:** 12" overall (6" bbl.) **Grips:** Smooth. **Sights:** 1/8" serrated front, white outline rear adjustable for windage and elevation. **Features:** Available in blue or stainless steel. Smooth, wide trigger with adjustable over-travel, wide hammer spur. Available in Pistol Pac set also. Reintroduced 1997. Contact Dan Wesson Firearms for complete price list.

**Price:** 41 Mag., 4", vent heavy (blue or stainless) ..... \$643.00

**Price:** 44 Mag., 6", vent heavy (blue or stainless) ..... \$689.00

**Price:** 45 Colt, 8", vent heavy (blue or stainless) ..... \$766.00

**Price:** Compensated models (all calibers) ..... \$812.00 to \$934.00

## DAN WESSON FIREARMS LARGE FRAME SERIES REVOLVERS

**Caliber:** 41, 741/41 Magnum; 44, 744/44 Magnum; 45, 745/45 Long Colt; 360, 7360/357; 460, 7460/45. **Barrel:** 2"-10". **Weight:** 49 oz.-69 oz. **Grips:** Standard, Hogue rubber Gripper Grips. **Sights:** Standard front, serrated ramp with color insert. Standard rear, adjustable wide notch. Other sight options available. **Features:** Available in blue or stainless steel. Smooth, wide trigger with overtravel, wide hammer spur. Double and single action.

**Price:** ..... \$769.00 to \$889.00

## DAN WESSON FIREARMS MODEL 360/7360 REVOLVERS

**Caliber:** 357 Mag. **Barrel:** 4", 6", 8", 10"; vent heavy. **Weight:** 64 oz. (8" barrel). **Grips:** Hogue rubber finger groove. **Sights:** Interchangeable ramp or Patridge front, fully adjustable rear. **Features:** New Generation Large Frame Series. Interchangeable barrels and grips; smooth trigger, wide hammer spur. Blue (360) or stainless (7360). Introduced 1999. Made in U.S.A. by Dan Wesson Firearms.

**Price:** 4" bbl., blue or stainless ..... \$735.00

**Price:** 10" bbl., blue or stainless ..... \$873.00

**Price:** Compensated models ..... \$858.00 to \$980.00

## DAN WESSON FIREARMS MODEL 460/7460 REVOLVERS

**Caliber:** 45 ACP, 45 Auto Rim, 45 Super, 45 Winchester Magnum and 460 Rowland. **Barrel:** 4", 6", 8", 10"; vent heavy. **Weight:** 49 oz. (4" barrel). **Grips:** Hogue rubber finger groove; interchangeable. **Sights:** Interchangeable ramp or Patridge front, fully adjustable rear. **Features:** New Generation Large Frame Series. Shoots five cartridges (45 ACP, 45 Auto Rim, 45 Super, 45 Winchester Magnum and 460 Rowland; six half-moon clips for auto cartridges included). Interchangeable barrels and grips. Available with non-fluted cylinder and Slotted Lightweight barrel shroud. Introduced 1999. Made in U.S.A. by Dan Wesson Firearms.

**Price:** 4" bbl., blue or stainless ..... \$735.00

**Price:** 10" bbl., blue or stainless ..... \$888.00

**Price:** Compensated models ..... \$919.00 to \$1,042.00



# HANDGUNS — DOUBLE ACTION REVOLVERS, SERVICE & SPORT



Medusa Model 47



Ruger GP-161



Ruger KGP-141

## EAA WINDICATOR REVOLVERS

**Caliber:** 38 Spec., 6-shot; 357 magnum, 6-shot. **Barrel:** 2", 4". **Weight:** 38 oz. (22 rimfire, 4"). **Length:** 8.5" overall (4" bbl.). **Grips:** Rubber with finger grooves. **Sights:** Blade front, fixed or adjustable on rimfires; fixed only on 32, 38. **Features:** Swing-out cylinder; hammer block safety; blue finish. Introduced 1991. Imported from Germany by European American Armory.

**Price:** 38 Special 2" ..... \$249.00  
**Price:** 38 Special, 4" ..... \$259.00  
**Price:** 357 Magnum, 2" ..... \$259.00  
**Price:** 357 Magnum, 4" ..... \$279.00

## KORTH COMBAT REVOLVER

**Caliber:** .357 Mag., .32 S&W Long, 9mm Para., .22 WMR, .22 LR. **Barrel:** 3", 4", 5-1/4", 6", 8". **Sights:** Fully-adjustable, rear; Baughman ramp, front. **Grips:** Walnut (checkered or smooth). Also available as a Target model in .22 LR, .38 Spl., .32 S&W Long, .357 Mag. with undercut partridge front sight; fully-adjustable rear. Made in Germany. Imported by Korth USA.

**Price:** ..... From \$5,442.00

## KORTH TROJA REVOLVER

**Caliber:** .357 Mag. **Barrel:** 6". **Finish:** Matte blue. **Grips:** Smooth, oversized finger contoured walnut. **Features:** Maintaining all of the precision German craftsmanship that has made this line famous, the final surface finish is not as finely polished as the firm's other products - thus the lower price. Introduced 2003. Imported from Germany by Korth USA.

**Price:** ..... From \$3,995.00

## MEDUSA MODEL 47 REVOLVER

**Caliber:** Most 9mm, 38 and 357 caliber cartridges; 6-shot cylinder. **Barrel:** 2-1/2", 3", 4", 5", 6"; fluted. **Weight:** 39 oz. **Length:** 10" overall (4" barrel). **Grips:** Gripper-style rubber. **Sights:** Changeable front blades, fully adjustable rear. **Features:** Patented extractor allows gun to chamber, fire and extract over 25 different cartridges in the .355 to .357 range, without half-moon clips. Steel frame and cylinder; match quality barrel. Matte blue finish. Introduced 1996. Made in U.S.A. by Phillips & Rogers, Inc.

**Price:** ..... \$899.00

## ROSSI MODEL 351/352 REVOLVERS

**Caliber:** 38 Special +P, 5-shot. **Barrel:** 2". **Weight:** 24 oz. **Length:** 6-1/2" overall. **Grips:** Rubber. **Sights:** Blade front, fixed rear. **Features:** Patented keylock Taurus Security System; forged steel frame handles +P ammunition. Introduced 2001. Imported by BrazTech/Taurus.

**Price:** Model 351 (blued finish) ..... \$298.00  
**Price:** Model 352 (stainless finish) ..... \$345.00

## ROSSI MODEL 461/462 REVOLVERS

**Caliber:** 357 Magnum +P, 6-shot. **Barrel:** 2". **Weight:** 26 oz. **Length:** 6-1/2" overall. **Grips:** Rubber. **Sights:** Fixed. **Features:** Single/double action. Patented keylock Taurus Security System; forged steel frame handles +P ammunition. Introduced 2001. Imported by BrazTech/Taurus.

**Price:** Model 461 (blued finish) ..... \$298.00  
**Price:** Model 462 (stainless finish) ..... \$345.00

## ROSSI MODEL 971/972 REVOLVERS

**Caliber:** 357 Magnum +P, 6-shot. **Barrel:** 4", 6". **Weight:** 40-44 oz. **Length:** 8-1/2" or 10-1/2" overall. **Grips:** Rubber. **Sights:** Fully adjustable. **Features:** Single/double action. Patented keylock Taurus Security

System; forged steel frame handles +P ammunition. Introduced 2001. Imported by BrazTech/Taurus.

**Price:** Model 971 (blued finish, 4" barrel) ..... \$345.00  
**Price:** Model 972 (stainless steel finish, 6" barrel) ..... \$391.00

## Rossi Model 851

Similar to Model 971/972, chambered for 38 Special +P. Blued finish, 4" barrel. Introduced 2001. From BrazTech/Taurus.

**Price:** ..... \$298.00

## RUGER GP-100 REVOLVERS

**Caliber:** 38 Spec., 357 Mag., 6-shot. **Barrel:** 3", 3" full shroud, 4", 4" full shroud, 6", 6" full shroud. **Weight:** 3" barrel-35 oz., 3" full shroud-36 oz., 4" barrel-37 oz., 4" full shroud-38 oz. **Sights:** Fixed; adjustable on 4" full shroud, all 6" barrels. **Grips:** Ruger Santoprene Cushioned Grip with Goncalo Alves inserts. **Features:** Uses action, frame incorporating improvements and features of both the Security-Six and Redhawk revolvers. Full length, short ejector shroud. Satin blue and stainless steel.

**Price:** GP-141 (357, 4" full shroud, adj. sights, blue) ..... \$499.00  
**Price:** GP-160 (357, 6", adj. sights, blue) ..... \$499.00  
**Price:** GP-161 (357, 6" full shroud, adj. sights, blue), 46 oz. .... \$499.00  
**Price:** GPF-331 (357, 3" full shroud) ..... \$495.00  
**Price:** GPF-340 (357, 4") ..... \$495.00  
**Price:** GPF-341 (357, 4" full shroud) ..... \$495.00  
**Price:** KGP-141 (357, 4" full shroud, adj. sights, stainless) ..... \$555.00  
**Price:** KGP-160 (357, 6", adj. sights, stainless), 43 oz. .... \$555.00  
**Price:** KGP-161 (357, 6" full shroud, adj. sights, stainless) 46 oz. .... \$555.00  
**Price:** KGPF-330 (357, 3", stainless) ..... \$555.00  
**Price:** KGPF-331 (357, 3" full shroud, stainless) ..... \$555.00  
**Price:** KGPF-340 (357, 4", stainless), KGPF-840 (38 Special) ... \$555.00  
**Price:** KGPF-341 (357, 4" full shroud, stainless) ..... \$555.00  
**Price:** KGPF-840 (38 Special, 4", stainless) ..... \$555.00

## Ruger SP101 Double-Action-Only Revolver

Similar to standard SP101 except double-action-only with no single-action sear notch. Spurless hammer for snag-free handling, floating firing pin and Ruger's patented transfer bar safety system. Available with 2-1/4" barrel in 357 Magnum. Weighs 25 oz., overall length 7.06". Natural brushed satin, high-polish stainless steel. Introduced 1993.

**Price:** KSP321XL (357 Mag.) ..... \$495.00

## RUGER SP101 REVOLVERS

**Caliber:** 22 LR, 32 H&R Mag., 6-shot; 38 Spec. +P, 357 Mag., 5-shot. **Barrel:** 2-1/4", 3-1/16", 4". **Weight:** (38 & 357 mag models) 2-1/4"-25 oz.; 3-1/16"-27 oz. **Sights:** Adjustable on 22, 32, fixed on others. **Grips:** Ruger Cushioned Grip with inserts. **Features:** Incorporates improvements and features found in the GP-100 revolvers into a compact, small frame, double-action revolver. Full-length ejector shroud. Stainless steel only. Introduced 1988.

# HANDGUNS — DOUBLE ACTION REVOLVERS, SERVICE & SPORT



Ruger KSP-331X

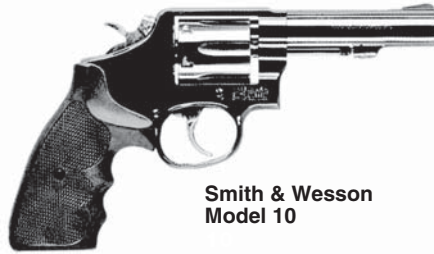

Smith & Wesson Model 10

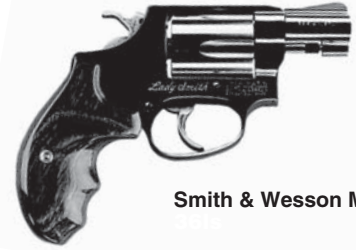

Smith & Wesson Model 36LS

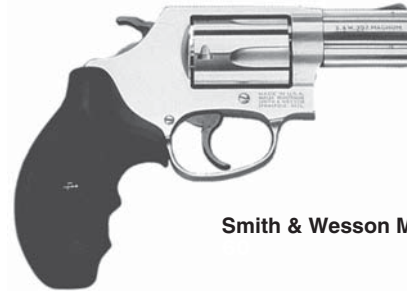

Smith & Wesson Model 65LS

Price: KSP-821X (2-1/4", 38 Spec.)	\$495.00
Price: KSP-831X (3-1/16", 38 Spec.)	\$495.00
Price: KSP-241X (4" heavy bbl., 22 LR), 34 oz.	\$495.00
Price: KSP-3231X (3-1/16", 32 H&R), 30 oz.	\$495.00
Price: KSP-321X (2-1/4", 357 Mag.)	\$495.00
Price: KSP-331X (3-1/16", 357 Mag.)	\$495.00
Price: KSP-3241X (32 Mag., 4" bbl)	\$495.00

## SMITH & WESSON MODEL 10 M&P HB REVOLVER

**Caliber:** 38 Spec., 6-shot. **Barrel:** 4". **Weight:** 33.5 oz. **Length:** 9-5/16" overall. **Grips:** Uncle Mike's Combat soft rubber; square butt. **Sights:** Fixed; ramp front, square notch rear.

**Price:** Blue ..... \$496.00

## SMITH & WESSON COMMEMORATIVE MODEL 29

**Features:** Reflects original Model 29: 6-1/2" barrel, four-screw side plate, over-sized target grips, red vamp front and black blade rear sights, 150th Anniversary logo, engraved, gold-plated, blue, in wood presentation case. Limited.

**Price:** ..... NA

## SMITH & WESSON MODEL 629 REVOLVERS

**Caliber:** 44 Magnum, 44 S&W Special, 6-shot. **Barrel:** 5", 6", 8-3/8". **Weight:** 47 oz. (6" bbl.). **Length:** 11-3/8" overall (6" bbl.). **Grips:** Soft rubber; wood optional. **Sights:** 1/8" red ramp front, white outline rear, internal lock, adjustable for windage and elevation.

**Price:** Model 629, 4" ..... \$717.00

**Price:** Model 629, 6" ..... \$739.00

**Price:** Model 629, 8-3/8" barrel ..... \$756.00

## Smith & Wesson Model 629 Classic Revolver

Similar to standard Model 629, full-lug 5", 6-1/2" or 8-3/8" barrel, chambered front of cylinder, interchangeable red ramp front sight with adjustable white outline rear, Hogue grips with S&W monogram, frame is drilled and tapped for scope mounting. Factory accurizing and endurance packages. Overall length with 5" barrel is 10-1/2"; weighs 51 oz. Introduced 1990.

**Price:** Model 629 Classic (stainless), 5", 6-1/2" ..... \$768.00

**Price:** As above, 8-3/8" ..... \$793.00

**Price:** Model 629 with HiViz front sight ..... \$814.00

## SMITH & WESSON MODEL 37 CHIEF'S SPECIAL & AIRWEIGHT

**Caliber:** 38 Spec. +P, 5-shot. **Barrel:** 1-7/8". **Weight:** 19-1/2 oz. (2" bbl.); 13-1/2 oz. (Airweight). **Length:** 6-1/2" (round butt). **Grips:** Round butt soft rubber. **Sights:** Fixed, serrated ramp front, square notch rear. Glass beaded finish.

**Price:** Model 37 ..... \$523.00

## Smith & Wesson Model 637 Airweight Revolver

Similar to the Model 37 Airweight except has alloy frame, stainless steel barrel, cylinder and yoke; rated for 38 Spec. +P; Uncle Mike's Boot Grip. Weighs 15 oz. Introduced 1996. Made in U.S.A. by Smith & Wesson.

**Price:** ..... \$548.00

## SMITH & WESSON MODEL 36LS, 60LS LADYSMITH

**Caliber:** .38 S&W Special +P, 5-shot. **Barrel:** 1-7/8". **Weight:** 20 oz. **Length:** 6-5/16" overall (1-7/8" barrel). **Grips:** Combat Dymondwood® grips with S&W monogram. **Sights:** Serrated ramp front, fixed notch rear. **Features:** Speedloader cutout. Comes in a fitted carry/storage case. Introduced 1989.

**Price:** Model 36LS ..... \$518.00

**Price:** Model 60LS, 2-1/8" barrel stainless, 357 Magnum ..... \$566.00

## SMITH & WESSON MODEL 60 CHIEF'S SPECIAL

**Caliber:** 357 Magnum, 5-shot. **Barrel:** 2-1/8" or 3". **Weight:** 24 oz. **Length:** 7-1/2" overall (3" barrel). **Grips:** Rounded butt synthetic grips. **Sights:** Fixed, serrated ramp front, square notch rear. **Features:** Stainless steel construction. 3" full lug barrel, adjustable sights, internal lock. Made in U.S.A. by Smith & Wesson.

**Price:** 2-1/8" barrel ..... \$541.00

**Price:** 3" barrel ..... \$574.00

## SMITH & WESSON MODEL 65

**Caliber:** 357 Mag. and 38 Spec., 6-shot. **Barrel:** 4". **Weight:** 34 oz. **Length:** 9-5/16" overall (4" bbl.). **Grips:** Uncle Mike's Combat. **Sights:** 1/8" serrated ramp front, fixed square notch rear. **Features:** Heavy barrel. Stainless steel construction. Internal lock.

**Price:** ..... \$531.00

## SMITH & WESSON MODEL 317 AIRLITE, 317 LADYSMITH REVOLVERS

**Caliber:** 22 LR, 8-shot. **Barrel:** 1-7/8" 3". **Weight:** 9.9 oz. **Length:** 6-3/16" overall. **Grips:** Dymondwood Boot or Uncle Mike's Boot. **Sights:** Serrated ramp front, fixed notch rear. **Features:** Aluminum alloy, carbon and stainless steels, and titanium construction. Short spur hammer, smooth combat trigger. Clear Cote finish. Introduced 1997. Made in U.S.A. by Smith & Wesson.

**Price:** With Uncle Mike's Boot grip ..... \$550.00

**Price:** With DymondWood Boot grip, 3" barrel, HiViz front sight, internal lock ..... \$600.00

**Price:** Model 317 LadySmith (DymondWood only, comes with display case) ..... \$596.00

## SMITH & WESSON MODEL 351PD

**Caliber:** 22 Mag. **Barrel:** 2". **Features:** Seven-shot, Scandium alloy.

**Price:** ..... \$625.00



# HANDGUNS — DOUBLE ACTION REVOLVERS, SERVICE & SPORT



Smith & Wesson  
Model 317 AirLite

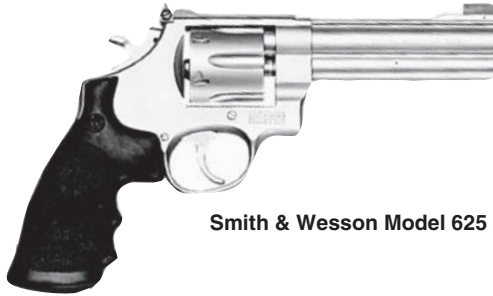

Smith & Wesson Model 625



Smith & Wesson  
Model 340 PD Airlite Sc

## SMITH & WESSON MODEL 64 STAINLESS M&P

**Caliber:** 38 Spec. +P, 6-shot. **Barrel:** 2", 3", 4". **Weight:** 34 oz. **Length:** 9-5/16" overall. **Grips:** Soft rubber. **Sights:** Fixed, 1/8" serrated ramp front, square notch rear. **Features:** Satin finished stainless steel, square butt.

**Price:** 2" ..... \$522.00  
**Price:** 3", 4" ..... \$532.00

## SMITH & WESSON MODEL 65LS LADYSMITH

**Caliber:** 357 Magnum, 38 Spec. +P, 6-shot. **Barrel:** 3". **Weight:** 31 oz. **Length:** 7.94" overall. **Grips:** Rosewood, round butt. **Sights:** Serrated ramp front, fixed notch rear. **Features:** Stainless steel with frosted finish. Smooth combat trigger, service hammer, shrouded ejector rod. Comes with case. Introduced 1992.

**Price:** ..... \$584.00

## SMITH & WESSON MODEL 66 STAINLESS COMBAT MAGNUM

**Caliber:** 357 Mag. and 38 Spec. +P, 6-shot. **Barrel:** 2-1/2", 4", 6". **Weight:** 36 oz. (4" barrel). **Length:** 9-9/16" overall. **Grips:** Soft rubber. **Sights:** Red ramp front, micro-click rear adjustable for windage and elevation. **Features:** Satin finish stainless steel. Internal lock.

**Price:** 2-1/2" ..... \$590.00  
**Price:** 4" ..... \$579.00  
**Price:** 6" ..... \$608.00

## SMITH & WESSON MODEL 67 COMBAT MASTERPIECE

**Caliber:** 38 Special, 6-shot. **Barrel:** 4". **Weight:** 32 oz. **Length:** 9-5/16" overall. **Grips:** Soft rubber. **Sights:** Red ramp front, micro-click rear adjustable for windage and elevation. **Features:** Stainless steel with satin finish. Smooth combat trigger, semi-target hammer. Introduced 1994.

**Price:** ..... \$585.00

## Smith & Wesson Model 686 Magnum PLUS Revolver

Similar to the Model 686 except has 7-shot cylinder, 2-1/2", 4" or 6" barrel. Weighs 34-1/2 oz., overall length 7-1/2" (2-1/2" barrel). Hogue rubber grips. Internal lock. Introduced 1996. Made in U.S.A. by Smith & Wesson.

**Price:** 2-1/2" barrel ..... \$631.00  
**Price:** 4" barrel ..... \$653.00  
**Price:** 6" barrel ..... \$663.00

## SMITH & WESSON MODEL 625 REVOLVER

**Caliber:** 45 ACP, 6-shot. **Barrel:** 5". **Weight:** 46 oz. **Length:** 11.375" overall. **Grips:** Soft rubber; wood optional. **Sights:** Patridge front on ramp, S&W micrometer click rear adjustable for windage and elevation. **Features:** Stainless steel construction with .400" semi-target hammer, .312" smooth combat trigger; full lug barrel. Glass beaded finish. Introduced 1989.

**Price:** 5" ..... \$745.00  
**Price:** 4" with internal lock ..... \$745.00

## SMITH & WESSON MODEL 640 CENTENNIAL DA ONLY

**Caliber:** 357 Mag., 38 Spec. +P, 5-shot. **Barrel:** 2-1/8". **Weight:** 25 oz. **Length:** 6-3/4" overall. **Grips:** Uncle Mike's Boot Grip. **Sights:** Serrated ramp front, fixed notch rear. **Features:** Stainless steel. Fully concealed hammer, snag-proof smooth edges. Internal lock. Introduced 1995 in 357 Magnum.

**Price:** ..... \$599.00



Smith & Wesson Model 360 PD  
Airlite SC Chief's Special

## SMITH & WESSON MODEL 617 K-22 MASTERPIECE

**Caliber:** 22 LR, 6- or 10-shot. **Barrel:** 4", 6", 8-3/8". **Weight:** 42 oz. (4" barrel). **Length:** NA. **Grips:** Soft rubber. **Sights:** Patridge front, adjustable rear. Drilled and tapped for scope mount. **Features:** Stainless steel with satin finish; 4" has .312" smooth trigger, .375" semi-target hammer; 6" has either .312" combat or .400" serrated trigger, .375" semi-target or .500" target hammer; 8-3/8" with .400" serrated trigger, .500" target hammer. Introduced 1990.

**Price:** 4" ..... \$644.00  
**Price:** 6", target hammer, target trigger ..... \$625.00  
**Price:** 6", 10-shot ..... \$669.00  
**Price:** 8-3/8", 10 shot ..... \$679.00

## SMITH & WESSON MODEL 610 CLASSIC HUNTER REVOLVER

**Caliber:** 10mm, 40 S&W, 6-shot cylinder. **Barrel:** 6-1/2" full lug. **Weight:** 52 oz. **Length:** 12" overall. **Grips:** Hogue rubber combat. **Sights:** Interchangeable blade front, micro-click rear adjustable for windage and elevation. **Features:** Stainless steel construction; target hammer, target trigger; unfluted cylinder; drilled and tapped for scope mounting. Introduced 1998.

**Price:** ..... \$785.00

## SMITH & WESSON MODEL 340 PD AIRLITE Sc CENTENNIAL

**Caliber:** 357 Magnum, 38 Spec. +P, 5-shot. **Barrel:** 1-7/8". **Grips:** Rounded butt grip. **Sights:** HiViz front. **Features:** Synthetic grip, internal lock. Blue.

**Price:** ..... \$799.00

## SMITH & WESSON MODEL 360 PD AIRLITE Sc CHIEF'S SPECIAL

**Caliber:** 357 Magnum, 38 Spec. +P, 5-shot. **Barrel:** 1-7/8". **Grips:** Rounded butt grip. **Sights:** Fixed. **Features:** Synthetic grip, internal lock. Stainless.

**Price:** Red ramp front ..... \$767.00  
**Price:** HiViz front ..... \$781.00

## SMITH & WESSON MODEL 386 PD AIRLITE Sc

**Caliber:** 357 Magnum, 38 Spec. +P, 7-shot. **Barrel:** 2-1/2". **Grips:** Rounded butt grip. **Sights:** Adjustable, HiViz front. **Features:** Synthetic grip, internal lock.

**Price:** Blue ..... \$815.00

# HANDGUNS — DOUBLE ACTION REVOLVERS, SERVICE & SPORT

HANDGUNS

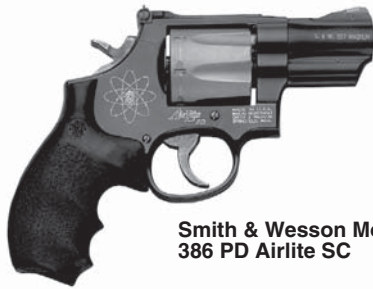

Smith & Wesson Model 386 PD Airlite SC

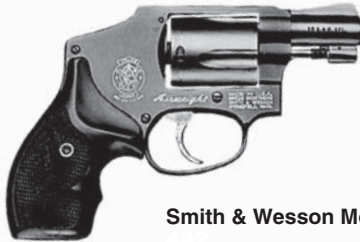

Smith & Wesson Model 442

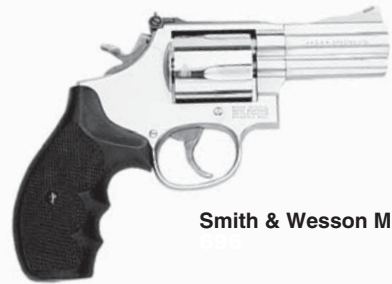

Smith & Wesson Model 696



Taurus Model 82

## Smith & Wesson Model 642LS Ladysmith Revolver

Same as Model 642 except has smooth combat wood grips, comes with deluxe soft case; Dymondwood grip; aluminum alloy frame, stainless cylinder, barrel and yoke; frosted matte finish. Weighs 15.8 oz. Introduced 1996. Made in U.S.A. by Smith & Wesson.

Price: 1-7/8" ..... \$597.00

## SMITH & WESSON MODEL 649 BODYGUARD REVOLVER

Caliber: 357 Mag., 38 Spec. +P, 5-shot. Barrel: 2-1/8". Weight: 20 oz. Length: 6-5/16" overall. Grips: Uncle Mike's Combat. Sights: Black pinned ramp front, fixed notch rear. Features: Stainless steel construction; shrouded hammer; smooth combat trigger. Internal lock. Made in U.S.A. by Smith & Wesson.

Price: ..... \$594.00

## SMITH & WESSON MODEL 657 REVOLVER

Caliber: 41 Mag., 6-shot. Barrel: 7-1/2" full lug. Weight: 48 oz. Grips: Soft rubber. Sights: Pinned 1/8" red ramp front, micro-click rear adjustable for windage and elevation. Target hammer, drilled and tapped, unfluted cylinder. Features: Stainless steel construction.

Price: ..... \$706.00

## SMITH & WESSON MODEL 696 REVOLVER

Caliber: 44 Spec., 5-shot. Barrel: 3". Weight: 35.5 oz. Length: 8-1/4" overall. Grips: Uncle Mike's Combat. Sights: Red ramp front, click adjustable white outline rear. Features: Stainless steel construction; round butt frame; satin finish. Introduced 1997. Made in U.S.A. by Smith & Wesson.

Price: ..... \$620.00

## TAURUS MODEL 65 REVOLVER

Caliber: 357 Mag., 6-shot. Barrel: 4". Weight: 38 oz. Length: 10-1/2" overall. Grips: Soft rubber. Sights: Fixed. Features: Double action, integral keylock. Imported by Taurus International.

Price: Blue or matte stainless ..... \$375.00 to \$422.00

## Taurus Model 66 Revolver

Similar to Model 65, 4" or 6" barrel, 7-shot cylinder, adjustable rear sight. Integral keylock action. Imported by Taurus International.

Price: Blue or matte stainless ..... \$422.00 to \$469.00

## TAURUS MODEL 82 HEAVY BARREL REVOLVER

Caliber: 38 Spec., 6-shot. Barrel: 4", heavy. Weight: 36.5 oz. Length: 9-1/4" overall (4" bbl.). Grips: Soft black rubber. Sights: Serrated ramp front, square notch rear. Features: Double action, solid rib, integral keylock. Imported by Taurus International.

Price: Blue or matte stainless ..... \$352.00 to \$398.00

## TAURUS MODEL 85 REVOLVER

Caliber: 38 Spec., 5-shot. Barrel: 2". Weight: 17-24.5 oz., titanium 13.5-15.4 oz. Grips: Rubber, rosewood or mother-of-pearl. Sights: Ramp front, square notch rear. Features: Blue, matte stainless, blue with gold accents, stainless with gold accents; rated for +P ammo. Integral keylock. Introduced 1980. Imported by Taurus International.

Price: ..... \$375.00 to \$547.00  
Price: Total Titanium ..... \$531.00

## SMITH & WESSON MODEL 331, 332 AIRLITE Ti REVOLVERS

Caliber: 32 H&R Mag., 6-shot. Barrel: 1-7/8". Weight: 11.2 oz. (with wood grip). Length: 6-15/16" overall. Grips: Uncle Mike's Boot or Dymondwood Boot. Sights: Black serrated ramp front, fixed notch rear. Features: Aluminum alloy frame, barrel shroud and yoke; titanium cylinder; stainless steel barrel liner. Matte finish. Introduced 1999. Made in U.S.A. by Smith & Wesson.

Price: Model 331 Chiefs ..... \$716.00

Price: Model 332, internal lock ..... \$734.00

## SMITH & WESSON MODEL 337 CHIEF'S SPECIAL AIRLITE Ti

Caliber: 38 Spec. +P, 5-shot. Barrel: 1-7/8". Weight: 11.2 oz. (Dymondwood grips). Length: 6-5/16" overall. Grips: Uncle Mike's Boot or Dymondwood Boot. Sights: Black serrated front, fixed notch rear. Features: Aluminum alloy frame, barrel shroud and yoke; titanium cylinder; stainless steel barrel liner. Matte finish. Introduced 1999. Made in U.S.A. by Smith & Wesson.

Price: ..... \$716.00

## SMITH & WESSON MODEL 342 CENTENNIAL AIRLITE Ti

Caliber: 38 Spec. +P, 5-shot. Barrel: 1-7/8". Weight: 11.3 oz. (Dymondwood stocks). Length: 6-15/16" overall. Grips: Uncle Mike's Boot or Dymondwood Boot. Sights: Black serrated ramp front, fixed notch rear. Features: Aluminum alloy frame, barrel shroud and yoke; titanium cylinder; stainless steel barrel liner. Shrouded hammer. Matte finish. Internal lock. Introduced 1999. Made in U.S.A. by Smith & Wesson.

Price: ..... \$734.00

## Smith & Wesson Model 442 Centennial Airweight

Similar to Model 640 Centennial, alloy frame giving weighs 15.8 oz. Chambered for 38 Special +P, 1-7/8" carbon steel barrel; carbon steel cylinder; concealed hammer; Uncle Mike's Boot grip. Fixed square notch rear sight, serrated ramp front. DA only, glass beaded finish. Introduced 1993.

Price: Blue ..... \$547.00

## SMITH & WESSON MODEL 638 AIRWEIGHT BODYGUARD

Caliber: 38 Spec. +P, 5-shot. Barrel: 1-7/8". Weight: 15 oz. Length: 6-15/16" overall. Grips: Uncle Mike's Boot grip. Sights: Serrated ramp front, fixed notch rear. Features: Alloy frame, stainless cylinder and barrel; shrouded hammer. Glass beaded finish. Introduced 1997. Made in U.S.A. by Smith & Wesson.

Price: With Uncle Mike's Boot grip ..... \$564.00

## Smith & Wesson Model 642 Airweight Revolver

Similar to Model 442 Centennial Airweight, stainless steel barrel, cylinder and yoke with matte finish; Uncle Mike's Boot Grip; DA only; weighs 15.8 oz. Introduced 1996. Made in U.S.A. by Smith & Wesson.

Price: ..... \$571.00



# HANDGUNS — DOUBLE ACTION REVOLVERS, SERVICE & SPORT



Taurus Model 85



Taurus Model 94 UL



Taurus Model 44



Taurus Model 415



Taurus Model 608

## TAURUS MODEL 94 REVOLVER

**Caliber:** 22 LR, 9-shot cylinder. **Barrel:** 2", 4", 5". **Weight:** 18.5-27.5 oz. **Grips:** Soft black rubber. **Sights:** Serrated ramp front, click-adjustable rear. **Features:** Double action, integral keylock. Introduced 1989. Imported by Taurus International.

**Price:** Blue ..... \$325.00  
**Price:** Matte stainless ..... \$375.00  
**Price:** Model 94 UL, forged aluminum alloy, 18-18.5 oz. .... \$365.00  
**Price:** As above, stainless. .... \$410.00

## TAURUS MODEL 44 REVOLVER

**Caliber:** 44 Mag., 6-shot. **Barrel:** 4", 6-1/2", 8-3/8". **Weight:** 44-3/4 oz. **Grips:** Rubber. **Sights:** Adjustable. **Features:** Double action. Integral keylock. Introduced 1994. New Model 44S12 has 12" vent rib barrel. Imported from Brazil by Taurus International Manufacturing, Inc.

**Price:** Blue or stainless steel ..... \$445.00 to \$602.00

## TAURUS MODEL 415 REVOLVER

**Caliber:** 41 Mag., 5-shot. **Barrel:** 2-1/2". **Weight:** 30 oz. **Length:** 7-1/8" overall. **Grips:** Rubber. **Sights:** Fixed. **Features:** Stainless steel construction; matte finish; ported barrel. Double action. Integral keylock. Introduced 1999. Imported by Taurus International.

**Price:** ..... \$508.00  
**Price:** Total Titanium ..... \$602.00

## TAURUS MODEL 425/627 TRACKER REVOLVERS

**Caliber:** 357 Mag., 7-shot; 41 Mag., 5-shot. **Barrel:** 4" and 6". **Weight:** 28.8-40 oz. (titanium) 24.3-28. (6"). **Grips:** Rubber. **Sights:** Fixed front, adjustable rear. **Features:** Double action stainless steel, Shadow Gray or Total Titanium; vent rib (steel models only); integral keylock action. Imported by Taurus International.

**Price:** ..... \$508.00 to \$516.00  
**Price:** Total Titanium ..... \$688.00

## TAURUS MODEL 445

**Caliber:** 44 Special, 5-shot. **Barrel:** 2". **Weight:** 20.3-28.25 oz. **Length:** 6-3/4" overall. **Grips:** Rubber. **Sights:** Ramp front, notch rear. **Features:** Blue or stainless steel. Standard or DAO concealed hammer, optional porting. Introduced 1997. Imported by Taurus International.

**Price:** ..... \$345.00 to \$500.00  
**Price:** Total Titanium 19.8 oz. .... \$600.00

## TAURUS MODEL 455 "STELLAR TRACKER"

**Caliber:** 45 ACP, 5-shot. **Barrel:** 2", 4", 6". **Weight:** 28/33/38.4 oz. **Grips:** Rubber. **Sights:** Adjustable. **Features:** Double action, matte stainless, includes five "Stellar" full-moon clips, integral keylock.

**Price:** ..... \$523.00

## TAURUS MODEL 460 "TRACKER"

**Caliber:** 45 Colt, 5-shot. **Barrel:** 4" or 6". **Weight:** 33/38.4 oz. **Grips:** Rubber. **Sights:** Adjustable. **Features:** Double action, ventilated rib, matte stainless steel, comes with five "Stellar" full-moon clips.

**Price:** ..... \$516.00  
**Price:** ..... (Shadow gray, Total Titanium) \$688.00

## TAURUS MODEL 605 REVOLVER

**Caliber:** 357 Mag., 5-shot. **Barrel:** 2". **Weight:** 24 oz. **Grips:** Rubber. **Sights:** Fixed. **Features:** Double action, blue or stainless, concealed hammer models DAO, porting optional, integral keylock. Introduced 1995. Imported by Taurus International.

**Price:** ..... \$375.00 to \$438.00

## Taurus Model 731 Revolver

Similar to the Taurus Model 605, except in .32 Magnum.

**Price:** ..... \$438.00 to \$531.00

## TAURUS MODEL 608 REVOLVER

**Caliber:** 357 Mag. 38 Spec., 8-shot. **Barrel:** 4", 6-1/2", 8-3/8". **Weight:** 44-57 oz. **Length:** 9-3/8" overall. **Grips:** Soft black rubber. **Sights:** Adjustable. **Features:** Double action, integral keylock action. Available in blue or stainless. Introduced 1995. Imported by Taurus International.

**Price:** ..... \$469.00 to \$547.00

## Taurus Model 44 Series Revolver

Similar to Taurus Model 60 series, but in .44 Rem. Mag. With six-shot cylinder, blue and matte stainless finishes.

**Price:** ..... \$500.00 to \$578.00

## TAURUS MODEL 650CIA REVOLVER

**Caliber:** 357 Magnum, 5-shot. **Barrel:** 2". **Weight:** 24.5 oz. **Grips:** Rubber. **Sights:** Ramp front, square notch rear. **Features:** Double-action only, blue or matte stainless steel, integral keylock, internal hammer. Introduced 2001. From Taurus International.

**Price:** ..... \$406.00 to \$453.00

# HANDGUNS — DOUBLE ACTION REVOLVERS, SERVICE & SPORT



Taurus Model 450



Taurus Model 817



Taurus Model 905

## TAURUS MODEL 651 CIA REVOLVER

**Caliber:** 357 Magnum, 5-shot. **Barrel:** 2". **Weight:** 17-24.5 oz. **Grips:** Rubber. **Sights:** Fixed. **Features:** Concealed single action/double action design. Shrouded cockable hammer, blue, matte stainless, Shadow Gray, Total Titanium, integral keylock. Made in Brazil. Imported by Taurus International Manufacturing, Inc.

**Price:** ..... \$406.00 to \$578.00

## TAURUS MODEL 450 REVOLVER

**Caliber:** 45 Colt, 5-shot. **Barrel:** 2". **Weight:** 21.2-22.3 oz. **Length:** 6-5/8" overall. **Grips:** Rubber. **Sights:** Ramp front, notch rear. **Features:** Double action, blue or stainless, ported, integral keylock. Introduced 1999. Imported from Brazil by Taurus International.

**Price:** ..... \$492.00

**Price:** Ultra-Lite (alloy frame) ..... \$523.00

**Price:** Total Titanium, 19.2 oz. .... \$600.00

## TAURUS MODEL 617 REVOLVER

**Caliber:** 357 Magnum, 7-shot. **Barrel:** 2". **Weight:** 28.3 oz. **Length:** 6-3/4" overall. **Grips:** Soft black rubber. **Sights:** Fixed. **Features:** Double action, blue, shadow gray, bright spectrum blue or matte stainless steel, integral keylock. Available with porting, concealed hammer. Introduced 1998. Imported by Taurus International.

**Price:** ..... \$391.00 to \$453.00

**Price:** Total Titanium, 19.9 oz. .... \$602.00

## Taurus Model 445 Series Revolver

Similar to Taurus Model 617 series except in .44 Spl. with 5-shot cylinder.

**Price:** ..... \$389.00 to \$422.00

## Taurus Model 617ULT Revolver

Similar to Model 617 except aluminum alloy and titanium components, matte stainless finish, integral key-lock action. Weighs 18.5 oz. Available ported or non-ported. Introduced 2001. Imported by Taurus International.

**Price:** (5-shot cylinder) ..... \$530.00 to \$545.00

## TAURUS MODEL 817 ULTRA-LITE REVOLVER

**Caliber:** 38 Spec., 7-shot. **Barrel:** 2". **Weight:** 21 oz. **Length:** 6-1/2" overall. **Grips:** Soft rubber. **Sights:** Fixed. **Features:** Double action, integral keylock. Rated for +P ammo. Introduced 1999. Imported from Brazil by Taurus International.

**Price:** Blue ..... \$375.00

**Price:** Blue, ported ..... \$395.00

**Price:** Matte, stainless ..... \$420.00

**Price:** Matte, stainless, ported ..... \$440.00

## TAURUS MODEL 850CIA REVOLVER

**Caliber:** 38 Special, 5-shot. **Barrel:** 2". **Weight:** 17-24.5 oz. **Grips:** Rubber. **Sights:** Ramp front, square notch rear. **Features:** Double action only, blue or matte stainless steel, rated for +P ammo, integral keylock, internal hammer. Introduced 2001. From Taurus International.

**Price:** ..... \$406.00 to \$453.00

**Price:** Total Titanium ..... \$578.00

## TAURUS MODEL 851CIA REVOLVER

**Caliber:** 38 Spec., 5-shot. **Barrel:** 2". **Weight:** 17-24.5 oz. **Grips:** Rubber. **Sights:** Fixed-UL/ULT adjustable. **Features:** Concealed single action/double action design. Shrouded cockable hammer, blue, matte stainless, Total Titanium, blue or stainless UL and ULT, integral keylock. Rated for +P ammo.

**Price:** ..... \$406.00 to \$578.00

## TAURUS MODEL 94, 941 REVOLVER

**Caliber:** 22 LR (Mod. 94), 22 WMR (Mod. 941), 8-shot. **Barrel:** 2", 4", 5". **Weight:** 27.5 oz. (4" barrel). **Grips:** Soft black rubber. **Sights:** Serrated ramp front, rear adjustable. **Features:** Double action, integral keylock. Introduced 1992. Imported by Taurus International.

**Price:** Blue ..... \$328.00 to \$344.00

**Price:** Stainless (matte) ..... \$375.00 to \$391.00

**Price:** Model 941 Ultra Lite, forged aluminum alloy, 2" ..... \$359.00 to \$375.00

**Price:** As above, stainless. .... \$406.00 to \$422.00

## TAURUS MODEL 905, 405, 455 PISTOL CALIBER REVOLVERS

**Caliber:** 9mm, .40, .45 ACP, 5-shot. **Barrel:** 2", 4", 6-1/2". **Weight:** 21 oz. to 40.8 oz. **Grips:** Rubber. **Sights:** Fixed, adjustable on Model 455SS6 in .45 ACP. **Features:** Produced as a backup gun for law enforcement officers who desire to carry the same caliber ammunition in their backup revolver as they do in their service sidearm. Introduced 2003. Imported from Brazil by Taurus International Manufacturing, Inc.

**Price:** ..... \$383.00 to \$523.00



# HANDGUNS — MISCELLANEOUS

*Specially adapted single-shot and multi-barrel arms.*



American Derringer Model 1



American Derringer Model 4



American Derringer Model 7



American Derringer Lady Derringer



American Derringer DA 38

## AMERICAN DERRINGER MODEL 1

**Caliber:** 22 LR, 22 WMR, 30 Carbine, 30 Luger, 30-30 Win., 32 H&R Mag., 32-20, 380 ACP, 38 Super, 38 Spec., 38 Spec. shotshell, 38 Spec. +P, 9mm Para., 357 Mag., 357 Mag./45/410, 357 Maximum, 10mm, 40 S&W, 41 Mag., 38-40, 44-40 Win., 44 Spec., 44 Mag., 45 Colt, 45 Win. Mag., 45 ACP, 45 Colt/410, 45-70 single shot. **Barrel:** 3". **Weight:** 15-1/2 oz. (38 Spec.). **Length:** 4.82" overall. **Grips:** Rosewood, Zebra wood. **Sights:** Blade front. **Features:** Made of stainless steel with high-polish or satin finish. Two-shot capacity. Manual hammer block safety. Introduced 1980. Available in almost any pistol caliber. Contact the factory for complete list of available calibers and prices. From American Derringer Corp.

<b>Price:</b> 22 LR	POR
<b>Price:</b> 38 Spec.	POR
<b>Price:</b> 357 Maximum	POR
<b>Price:</b> 357 Mag.	POR
<b>Price:</b> 9mm, 380	POR
<b>Price:</b> 40 S&W	POR
<b>Price:</b> 44 Spec.	POR
<b>Price:</b> 44-40 Win.	POR
<b>Price:</b> 45 Colt	POR
<b>Price:</b> 30-30, 45 Win. Mag.	POR
<b>Price:</b> 41, 44 Mags.	POR
<b>Price:</b> 45-70, single shot	POR
<b>Price:</b> 45 Colt, 410, 2-1/2"	POR
<b>Price:</b> 45 ACP, 10mm Auto	POR

## American Derringer Model 4

Similar to the Model 1 except has 4.1" barrel, overall length of 6", and weighs 16-1/2 oz.; chambered for 357 Mag., 357 Maximum, 45-70, 3" 410-bore shotshells or 45 Colt or 44 Mag. Made of stainless steel. Manual hammer block safety. Introduced 1980.

<b>Price:</b> 3" 410/45 Colt	\$425.00
<b>Price:</b> 45-70	\$560.00
<b>Price:</b> 44 Mag. with oversize grips	\$515.00
<b>Price:</b> Alaskan Survival model (45-70 upper barrel, 410 or 45 Colt lower)	\$475.00

## American Derringer Model 7 Ultra Lightweight

Similar to Model 1 except made of high strength aircraft aluminum. Weighs 7-1/2 oz., 4.82" o.a.l., rosewood stocks. Available in 22 LR, 22 WMR, 32 H&R Mag., 380 ACP, 38 Spec., 44 Spec. Introduced 1980.

<b>Price:</b> 22 LR, WMR	\$325.00
<b>Price:</b> 38 Spec.	\$325.00
<b>Price:</b> 380 ACP	\$325.00
<b>Price:</b> 32 H&R Mag/32 S&W Long	\$325.00
<b>Price:</b> 44 Spec.	\$565.00

## American Derringer Model 10 Ultra Lightweight

Similar to the Model 1 except frame is of aluminum, giving weight of 10 oz. Stainless barrels. Available in 38 Spec., 45 Colt or 45 ACP only. Matte gray finish. Introduced 1980.

<b>Price:</b> 45 Colt	\$385.00
<b>Price:</b> 45 ACP	\$330.00
<b>Price:</b> 38 Spec.	\$305.00

## American Derringer Lady Derringer

Same as the Model 1 except has tuned action, is fitted with scrimshawed synthetic ivory grips; chambered for 32 H&R Mag. and 38 Spec.; 357 Mag., 45 Colt, 45/410. Deluxe Grade is highly polished; Deluxe Engraved is engraved in a pattern similar to that used on 1880s derringers. All come in a French-fitted jewelry box. Introduced 1989.

<b>Price:</b> 32 H&R Mag.	\$375.00
<b>Price:</b> 357 Mag.	\$405.00
<b>Price:</b> 38 Spec.	\$360.00
<b>Price:</b> 45 Colt, 45/410	\$435.00

## American Derringer Texas Commemorative

A Model 1 Derringer with solid brass frame, stainless steel barrel and rosewood grips. Available in 38 Spec., 44-40 Win., or 45 Colt. Introduced 1980.

<b>Price:</b> 38 Spec.	\$365.00
<b>Price:</b> 44-40	\$420.00
<b>Price:</b> Brass frame, 45 Colt	\$450.00

## AMERICAN DERRINGER DA 38 MODEL

**Caliber:** 22 LR, 9mm Para., 38 Spec., 357 Mag., 40 S&W. **Barrel:** 3". **Weight:** 14.5 oz. **Length:** 4.8" overall. **Grips:** Rosewood, walnut or other hardwoods. **Sights:** Fixed. **Features:** Double-action only; two-shots. Manual safety. Made of satin-finished stainless steel and aluminum. Introduced 1989. From American Derringer Corp.

<b>Price:</b> 22 LR	\$435.00
<b>Price:</b> 38 Spec.	\$460.00
<b>Price:</b> 9mm Para.	\$445.00
<b>Price:</b> 357 Mag.	\$450.00
<b>Price:</b> 40 S&W	\$475.00

## ANSCHUTZ MODEL 64P SPORT/TARGET PISTOL

**Caliber:** 22 LR, 22 WMR, 5-shot magazine. **Barrel:** 10". **Weight:** 3 lbs., 8 oz. **Length:** 18-1/2" overall. **Stock:** Choate Rynite. **Sights:** None furnished; grooved for scope mounting. **Features:** Right-hand bolt; polished blue finish. Introduced 1998. Imported from Germany by AcuSport.

<b>Price:</b> 22 LR	\$455.95
<b>Price:</b> 22 WMR	\$479.95

# HANDGUNS — MISCELLANEOUS



Bond Arms Texas Defender



Bond Arms Century 2000 Defender



Cobra Big Bore

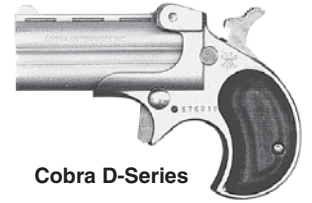

Cobra D-Series



Downsizer WSP Single Shot



Maximum Single Shot

## BOND ARMS DEFENDER DERRINGER

**Caliber:** 410 Buckshot or slug, 45 Colt/45 Schofield (2.5" chamber), 45 Colt (only), 450 Bond Super/45 ACP/45 Super, 44 Mag./44 Special/44 Russian, 10mm, 40 S&W, 357 SIG, 357 Maximum/357 Mag./38 Special, 357 Mag./38 Special & 38 Long Colt, 38 Short Colt, 9mm Luger (9x19), 32 H&R Mag./38 S&W Long/32 Colt New Police, 22 Mag., 22 LR., 38-40, 44-40. **Barrel:** 3", 3-1/2". **Weight:** 20-21 oz. **Length:** 5"-5-1/2". **Grips:** Exotic woods or animal horn. **Sights:** Blade front, fixed rear. **Features:** Interchangeable barrels, retracting and rebounding firing pins, cross-bolt safety, automatic extractor for rimmed calibers. Stainless steel construction. Right- or left-hand.

**Price:** Texas (with TG) 3" bbl. . . . . \$379.00

**Price:** Super (with TG) 3" bbl., 450 Bond Super and 45 ACP . . . \$379.00

**Price:** Cowboy (no TG) . . . . . \$379.00

**Price:** Century 2000 (with TG), Cowboy Century 2000 (no TG), 3-1/2" bbls., 410/45 Colt . . . . . \$394.00

**Price:** Additional calibers - available separately

## BROWN CLASSIC SINGLE SHOT PISTOL

**Caliber:** 17 Ackley Hornet through 375x444. **Barrel:** 15" air gauged match grade. **Weight:** About 3 lbs., 7 oz. **Grips:** Walnut; thumbrest target style. **Sights:** None furnished; drilled and tapped for scope mounting. **Features:** Falling block action gives rigid barrel-receiver mating; hand-fitted and headspaced. Introduced 1998. Made in U.S.A. by E.A. Brown Mfg.

**Price:** . . . . . \$589.00

## COBRA BIG BORE DERRINGERS

**Caliber:** 22 WMR, 32 H&R Mag, 38 Spec., 9mm Para. **Barrel:** 2.75". **Weight:** 11.5 oz. **Length:** 4.65" overall. **Grips:** Textured black synthetic. **Sights:** Blade front, fixed notch rear. **Features:** Alloy frame, steel-lined barrels, steel breech block. Plunger-type safety with integral hammer block. Chrome or black Teflon finish. Introduced 2002. Made in U.S.A. by Cobra Enterprises.

**Price:** . . . . . \$98.00

**Price:** 9mm Para. . . . . \$136.00

## COBRA LONG-BORE DERRINGERS

**Caliber:** 22 WMR, 38 Spec., 9mm Para. **Barrel:** 3.5". **Weight:** 13 oz. **Length:** 5.65" overall. **Grips:** Textured black synthetic. **Sights:** Fixed.

**Features:** Chrome or black Teflon finish. Larger than Davis D-Series models. Introduced 2002. Made in U.S.A. by Cobra Enterprises.

**Price:** . . . . . \$136.00

**Price:** 9mm Para. . . . . \$136.00

**Price:** Big-Bore models (same calibers, 3/4" shorter barrels). . . . \$136.00

## COBRA STARBIRD-SERIES DERRINGERS

**Caliber:** 22 LR, 22 WMR, 25 ACP, 32 ACP. **Barrel:** 2.4". **Weight:** 9.5 oz. **Length:** 4" overall. **Grips:** Laminated wood or pearl. **Sights:** Blade front, fixed notch rear. **Features:** Choice of black powder coat, satin nickel or chrome finish; spur trigger. Introduced 2002. Made in U.S.A. by Cobra Enterprises.

**Price:** . . . . . \$112.00

## DOWNSIZER WSP SINGLE SHOT PISTOL

**Caliber:** 357 Magnum, 45 ACP, 38 Special. **Barrel:** 2.10." **Weight:** 11 oz. **Length:** 3.25" overall. **Grips:** Black polymer. **Sights:** None. **Features:** Single shot, tip-up barrel. Double action only. Stainless steel construction. Measures .900" thick. Introduced 1997. From Downsizer Corp.

**Price:** . . . . . \$499.00

## MAXIMUM SINGLE SHOT PISTOL

**Caliber:** 22 LR, 22 Hornet, 22 BR, 22 PPC, 223 Rem., 22-250, 6mm BR, 6mm PPC, 243, 250 Savage, 6.5mm-35M, 270 MAX, 270 Win., 7mm TCU, 7mm BR, 7mm-35, 7mm INT-R, 7mm-08, 7mm Rocket, 7mm Super-Mag., 30 Herrett, 30 Carbine, 30-30, 308 Win., 30x39, 32-20, 350 Rem. Mag., 357 Mag., 357 Maximum, 358 Win., 375 H&H, 44 Mag., 454 Casull. **Barrel:** 8-3/4", 10-1/2", 14". **Weight:** 61 oz. (10-1/2" bbl.); 78 oz. (14" bbl.). **Length:** 15", 18-1/2" overall (with 10-1/2" and 14" bbl., respectively). **Grips:** Smooth walnut stocks and forend. Also available with 17" finger groove grip. **Sights:** Ramp front, fully adjustable open rear. **Features:** Falling block action; drilled and tapped for M.O.A. scope mounts; integral grip frame/receiver; adjustable trigger; Douglas barrel (interchangeable). Introduced 1983. Made in U.S.A. by M.O.A. Corp.

**Price:** Stainless receiver, blue barrel . . . . . \$799.00

**Price:** Stainless receiver, stainless barrel . . . . . \$883.00

**Price:** Extra blued barrel . . . . . \$254.00

**Price:** Extra stainless barrel . . . . . \$317.00

**Price:** Scope mount . . . . . \$60.00



# SHOTGUNS — MILITARY & POLICE



Mossberg Model 500 Persuader



Tactical Response TR-870



Winchester Model 1300  
Camp Defender®

## MOSSBERG MODEL 500 PERSUADER SECURITY SHOTGUNS

**Gauge:** 12, 20, .410, 3" chamber. **Barrel:** 18-1/2", 20" (Cyl.). **Weight:** 7 lbs. **Stock:** Walnut-finished hardwood or black synthetic. **Sights:** Metal bead front. **Features:** Available in 6- or 8-shot models. Top-mounted safety, double action slide bars, swivel studs, rubber recoil pad. Blue, Parkerized, Marinecote finishes. Mossberg Cablelock included. From Mossberg.

**Price:** 12 ga., 18-1/2", blue, wood or synthetic stock, 6-shot . . . . \$353.00  
**Price:** Cruiser, 12 ga., 18-1/2", blue, pistol grip, heat shield . . . . \$357.00  
**Price:** As above, 20 ga. or .410 bore. . . . . \$345.00

## Mossberg Model 500, 590 Mariner Pump

Similar to the Model 500 or 590 Security except all metal parts finished with Marinecote metal finish to resist rust and corrosion. Synthetic field stock; pistol grip kit included. Mossberg Cablelock included.

**Price:** 6-shot, 18-1/2" barrel . . . . . \$497.00  
**Price:** 9-shot, 20" barrel . . . . . \$513.00

## Mossberg Model 500, 590 Ghost-Ring Shotguns

Similar to the Model 500 Security except has adjustable blade front, adjustable Ghost-Ring rear sight with protective "ears." Model 500 has 18.5" (Cyl.) barrel, 6-shot capacity; Model 590 has 20" (Cyl.) barrel, 9-shot capacity. Both have synthetic field stock. Mossberg Cablelock included. Introduced 1990. From Mossberg.

**Price:** 500 parkerized . . . . . \$468.00  
**Price:** 590 parkerized . . . . . \$543.00  
**Price:** 590 parkerized Speedfeed stock . . . . . \$586.00

## Mossberg Model HS410 Shotgun

Similar to the Model 500 Security pump except chambered for 20 gauge or .410 with 3" chamber; has pistol grip forend, thick recoil pad, muzzle brake and has special spreader choke on the 18.5" barrel. Overall length is 37.5", weight is 6.25 lbs. Blue finish; synthetic field stock. Mossberg Cablelock and video included. Introduced 1990.

**Price:** HS 410 . . . . . \$355.00

## MOSSBERG MODEL 590 SHOTGUN

**Gauge:** 12, 3" chamber. **Barrel:** 20" (Cyl.). **Weight:** 7-1/4 lbs. **Stock:** Synthetic field or Speedfeed. **Sights:** Metal bead front. **Features:** Top-mounted safety, double slide action bars. Comes with heat shield, bayonet lug, swivel studs, rubber recoil pad. Blue, Parkerized or Marinecote finish. Mossberg Cablelock included. From Mossberg.

**Price:** Blue, synthetic stock . . . . . \$417.00  
**Price:** Parkerized, synthetic stock . . . . . \$476.00  
**Price:** Parkerized, Speedfeed stock . . . . . \$519.00

## TACTICAL RESPONSE TR-870 STANDARD MODEL SHOTGUN

**Gauge:** 12, 3" chamber, 7-shot magazine. **Barrel:** 18" (Cyl.). **Weight:** 9 lbs. **Length:** 38" overall. **Stock:** Fiberglass-filled polypropylene with non-slug recoil absorbing butt pad. Nylon tactical forend houses flashlight. **Sights:** Trak-Lock ghost ring sight system. Front sight has tritium insert. **Features:** Highly modified Remington 870P with Parkerized finish. Comes with nylon three-way adjustable sling, high visibility non-binding follower, high performance magazine spring, Jumbo Head safety, and Side Saddle extended 6-shot shell carrier on left side of receiver. Introduced 1991. From Scattergun Technologies, Inc.

**Price:** Standard model . . . . . \$815.00  
**Price:** FBI model . . . . . \$770.00  
**Price:** Patrol model . . . . . \$595.00  
**Price:** Border Patrol model . . . . . \$605.00  
**Price:** K-9 model (Rem. 11-87 action) . . . . . \$995.00  
**Price:** Urban Sniper, Rem. 11-87 action . . . . . \$1,290.00  
**Price:** Louis Awerbuck model . . . . . \$705.00  
**Price:** Practical Turkey model . . . . . \$725.00  
**Price:** Expert model . . . . . \$1,350.00  
**Price:** Professional model . . . . . \$815.00  
**Price:** Entry model . . . . . \$840.00  
**Price:** Compact model . . . . . \$635.00  
**Price:** SWAT model . . . . . \$1,195.00

## WINCHESTER MODEL 1300 DEFENDER PUMP GUN

**Gauge:** 12, 20, 3" chamber, 5- or 8-shot capacity. **Barrel:** 18" (Cyl.). **Weight:** 6-3/4 lbs. **Length:** 38-5/8" overall. **Stock:** Walnut-finished hardwood stock and ribbed forend, synthetic or pistol grip. **Sights:** Metal bead front or TRUGLO® fiber-optic. **Features:** Cross-bolt safety, front-locking rotary bolt, twin action slide bars. Black rubber butt pad. From U.S. Repeating Arms Co.

**Price:** 8-Shot (black synthetic stock, TRUGLO® sight) . . . . . \$343.00  
**Price:** 8-Shot Pistol Grip (pistol grip synthetic stock) . . . . . \$343.00

## Winchester Model 1300 Coastal Pump Gun

Same as the Defender 8-Shot except has bright chrome finish, nickel-plated barrel, bead front sight. Phosphate coated receiver for corrosion resistance.

**Price:** . . . . . \$576.00

## Winchester Model 1300 Camp Defender®

Same as the Defender 8-Shot except has hardwood stock and forearm, fully adjustable open sights and 22" barrel with WinChoke® choke tube system (cylinder choke tube included). Weighs 6-7/8 lbs. Introduced 2001. From U.S. Repeating Arms Co.

**Price:** Camp Defender® . . . . . \$392.00



# GRIPS

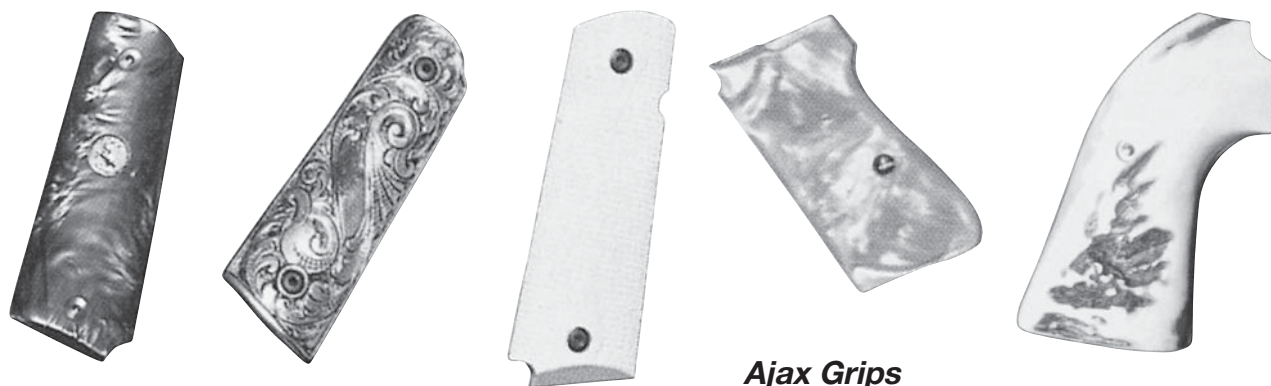

**Ajax Grips**

## AJAX

Grip materials include genuine stag, buffalo horn, ivory polymer, white and black Pearlite, exotic woods, buffalo polymer, pewter, genuine ivory and Staglite (imitation stag horn). Available for most single- and double-action revolvers and semi-automatic pistols. Custom fittings are available.

**Prices:** Genuine stag ..... \$199.95 to \$249.95  
**Prices:** Genuine buffalo horn ..... \$60.00 to \$80.00  
**Prices:** Ivory polymer ..... \$35.00 to \$90.00  
**Prices:** Pearlite ..... \$35.00 to \$90.00  
**Prices:** Exotic woods (super walnut, cherrywood, black Silverwood) ..... \$14.95 to \$50.00  
**Prices:** Buffalo polymer ..... \$35.00 to \$45.00

**Prices:** Pewter ..... \$50.00 to \$60.00  
**Prices:** Genuine ivory ..... \$325.00 to \$350.00  
**Prices:** Staglite ..... \$49.95 to \$59.95  
 Textured decal grips in various textures also available from Ajax for many semi-automatic pistols.  
**Prices:** ..... \$9.95



**Alumna Grips**

## ALUMNA GRIPS

Aluminum handgun grips available in several configurations including checkered, UltraLight, ThinLine, olive gray finish, laser engraved and Custom Deluxe with up to 3 engraved initials. Anodized aluminum colors also available.

**Prices:** ..... \$39.95 to \$44.95

### BLU MAGNUM GRIPS

Makers of double- and single-action style grips in Skeeter Skelton, Sheriff Wilson and other styles, made of maple and exotic woods, ivory, stag, and Micarta.

**Prices:** ..... N/A

### BROWNELLS

Not a manufacturer, but an on-line and catalog retailer, supplying gunsmiths and retailers, as well as the shooting public. Many of the products shown in this section are also available from Brownells.



# GRIPS

## **BUTLER CREEK (UNCLE MIKE'S)**

Designed by handgun stock designer and craftsman Craig Spegel, revolver and pistol grips made of polymer are available for a wide range of handgun models. Revolver grips are made to be hand-filling, but not oversize. Finger grooves are provided on double-action revolver grips for good control. Revolver boot grips are designed not to "print" when used on concealed-carry revolvers, yet allow a controlled rapid draw. Pistol grips are specifically designed to maintain the original stock dimensions. Slip-on grips are offered in three sizes. Medium and large versions have finger grooves.

**Prices:** Revolver and handgun grips ..... \$20.95  
**Prices:** Slip-on pistol grips ..... \$10.95

## **COAST IVORY**

Offers handguns grips of elephant ivory, stag, California buckeye burl and other exotic woods, as well as polyester pearl.

**Prices:** Custom-fitted elephant ivory for 1911-style pistols ..... \$450.00  
**Prices:** Custom-fitted ivory grips for Colt single-action revolvers ..... \$500.00 and up  
**Prices:** Custom-fitted Derringer pistol ivory grips ..... \$200.00 and up  
**Prices:** Custom-fitted genuine stag grips for Colt single-action revolvers ..... \$190.00  
**Prices:** Polyester pearl grips ..... \$60.00 to \$85.00



### *Crimson Trace Grips*

## **CRIMSON TRACE**

Makers of special grip replacements for many popular revolvers and pistols, including Lasergrip sighting systems. Lasergrips are intended for police agencies and military armed citizens.

**Prices:** ..... N/A

# GRIPS



*Eagle Grips*

## EAGLE GRIPS

Available grip materials include an extensive variety of rosewood, buffalo horn, ebony, mother-of-pearl, American elk, polymer and Ultra ivory (imitation of elephant ivory). Can produce grips for virtually any handgun. Custom-fittings available.

- Prices:** Rosewood or ebony handgun grips ..... \$39.95 to \$59.95
- Prices:** Compact revolver Secret Service grips ..... \$59.95 to \$125.95
- Prices:** Rosewood handgun thumb-rest grips (smooth finish) ..... \$59.95
- Prices:** Single-action revolver grips ..... \$59.95 to \$99.95

## FALCON INDUSTRIES, INC.



*Falcon Industries Grip*

Producer of the Ergo Grip XT for 1911-type Government and Colt Commander-size frames. Made of textured nylon-based rigid polymer with pebble grain grip surface.

**Price:** ..... \$22.00



*Herrett's Stocks, Inc. Grips*

## HERRETT'S STOCKS, INC.

Standard and custom hand-fitted grips made of American walnut. Exotic woods such as cocobolo and bubinga are available on request. Grips are available in configurations including target, Camp Perry, combat, field, Jordan trooper, detective, and others. Offered in a variety of checkering patterns, or smooth finish.

**Prices:** ..... \$19.95 to \$329.95



# GRIPS



**Hogue, Inc. Grips**

## HOGUE, INC.

Producer of a wide range of grips including the Monogrip, a one-piece design that slides on revolver frames from the bottom. Hand-All grip sleeves fit over the original grips of over 50 handgun models. Grip materials include soft rubber, nylon, laminated hardwoods and fancy hardwoods such as cocobolo, goncalo alves, pau ferro, and kingwood. Single-action revolver grips are available in materials such as white and black Micarta, white and black pearlized polymer, ebony, fancy walnut, ivory polymer and exotic hardwoods.

- Prices:** Revolver & pistol grips of rubber or nylon ..... **\$14.95 to \$22.95**
- Prices:** Revolver & pistol grips of goncalo alves or pau ferro ..... **\$24.95 to \$59.95**
- Prices:** Revolver & pistol grips of laminated or fancy woods ..... **\$24.95 to \$69.95**
- Prices:** Revolver & pistol grips of Kingwood, tulipwood or rosewood ..... **\$24.95 to \$79.95**
- Prices:** Single-action revolver grips wood, polymer or Micarta ..... **\$39.95 to \$79.95**

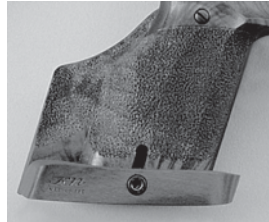

**Nill Grips**

## NILL GRIPS

Double-action revolver grips are available with closed or open backstrap area in walnut with smooth, stippled, checkered or Rhomlas finishes, with or without finger grooves in a variety of styles. Anatomical match grips with or without adjustable palm rest are available for standard cartridge handguns and air pistols, as are match grips for Olympic rapid-fire and free pistols.

- Prices:** Closed back revolver combat-style grips ..... **\$67.90 to \$116.00**
- Prices:** Open back revolver combat-style grips ..... **\$62.90 to \$88.90**
- Prices:** Combat-style grips for pistols ..... **\$54.90 to \$137.50**
- Prices:** Palm rest grips for revolvers ..... **\$109.90 to \$164.50**
- Prices:** Anatomical match grips with adjustable palm rest ..... **\$137.50 to \$155.00**

---

# GRIPS

---



## **PACHMAYR**

Models available in rubber, combination wood and rubber (American Legend Series), and slip-on variations. Some have steel inserts to improve function and finger grooves and/or a palm swell is available on some models. Decelerator rubber grips are designed to dampen recoil on heavy-kicking handguns. Signature grips are available in full wrap-around or without coverage of the pistol backstrap for use on handguns such as the 1911-style pistols with grip safety mechanisms. Slip-on grips come in five sizes to fit virtually any handgun. Compact grips are for small, concealed carry handguns.

## **PEARCE GRIP**

Producer of rubber grips for handgun models including those produced by Glock, Beretta, Colt, Makarov, Kahr Arms, Taurus and Para Ordnance. Highly contoured grips with palm swells, finger grooves and ultra-thin grip panels are available, depending on model.

**Prices:** ..... \$9.95 to \$24.95

## **WILSON COMBAT**

Grips for 1911-A1 style pistols in a variety of woods. Full-checked models available in cocobolo and Diamondwood. Slim Line grips are laminated from cocobolo or Diamondwood and are 1/3 the thickness of standard 1911-style grips. Exotic wood 1911 grips are offered in cocobolo, Kingwood and Diamondwood and have a double-diamond checkering pattern.

**Price:** ..... \$49.95 to \$59



# METALLIC SIGHTS



**AO Express**

## Handgun Sights

**AO EXPRESS SIGHTS** Low-profile, snag-free express-type sights. Shallow V rear with white vertical line, white dot front. All-steel, matte black finish. Rear is available in different heights. Made for most pistols, many with double set-screws. From AO Sight Systems, Inc.

Price: Standard Set, front and rear. . . . . \$60.00  
 Price: Big Dot Set, front and rear. . . . . \$60.00  
 Price: Tritium Set, Standard or Big Dot. . . . . \$90.00  
 Price: 24/7 Pro Express, Std. or Big Dot Tritium . . . . . \$120.00

**BO-MAR DELUXE BMCS** Gives 3/8" windage and elevation adjustment at 50 yards on Colt Gov't 45; sight radius under 7". For GM and Commander models only. Uses existing dovetail slot. Has shield-type rear blade.

Price: . . . . . \$65.95  
 Price: BMCS-2 (for GM and 9mm). \$68.95  
 Price: Flat bottom. . . \$65.95  
 Price: BMGC (for Colt Gold Cup), angled serrated blade, rear. . . . . \$68.95  
 Price: BMGC front sight. . . . . \$12.95  
 Price: BMCZ-75 (for CZ-75, TZ-75, P-9 and most clones). Works with factory front. . . . . \$68.95



**Bomar BMGS**

4506, 4516, 1076; undercut style (.250", .280", 5/16" high); Fast Draw style (.210", .250", .230" high).  
 Price: . . . . . \$12.95

**BO-MAR FRONT SIGHTS**  
 Dovetail style for S&W  
 Price: . . . . . \$12.95

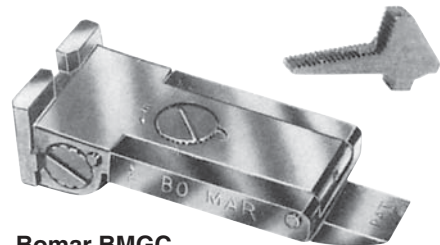

**Bomar BMGC**

**BO-MAR BMU XP-100/T/C CONTENDER**  
 No gunsmithing required; has .080" notch.  
 Price: . . . . . \$77.00

**BO-MAR BMML** For muzzleloaders; has .062" notch, flat bottom.  
 Price: . . . . . \$65.95  
 Price: With 3/8" dovetail. . . . . \$65.95



**Bomar BMU XP-100**

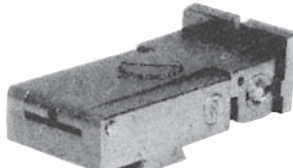

**Bomar BMML**

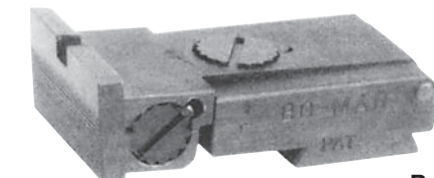

**Bomar BMR**

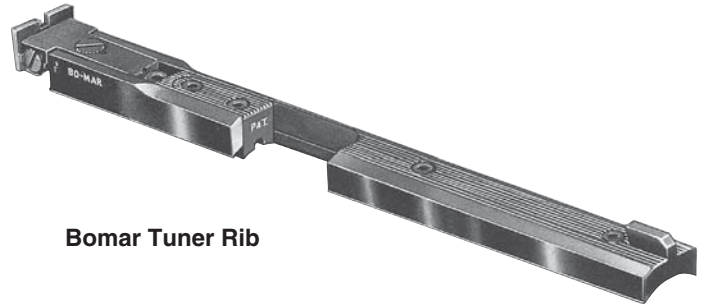

**Bomar Tuner Rib**

**BO-MAR RUGER "P" ADJUSTABLE SIGHT** Replaces factory front and rear sights.  
 Price: Rear sight. . . . . \$65.95  
 Price: Front sight. . . . . \$12.00

**BO-MAR BMR** Fully adjustable rear sight for Ruger MKI, MKII Bull barrel autos.  
 Price: Rear. . . . . \$65.95  
 Price: Undercut front sight. . . . . \$12.00

**BO-MAR GLOCK** Fully adjustable, all-steel replacement sights. Sight fits factory dovetail. Longer sight radius. Uses Novak Glock .275" high, .135" wide front, or similar.  
 Price: Rear sight. . . . . \$68.95  
 Price: Front sight. . . . . \$20.95

**BO-MAR LOW PROFILE RIB & ACCURACY TUNER** Streamlined rib with front and rear sights; 7 1/8" sight radius. Brings sight line closer to the bore than standard or extended sight and ramp. Weight 5 oz. Made for Colt Gov't 45, Super 38, and Gold Cup 45 and 38.  
 Price: . . . . . \$140.00



**Bomar Combat Rib**

**BO-MAR COMBAT RIB** For S&W Model 19 revolver with 4" barrel. Sight radius 5 3/4", weight 5 1/2 oz.  
 Price: . . . . . \$127.00



**Bomar Winged Rib**

**BO-MAR WINGED RIB** For S&W 4" and 6" length barrels-K-38, M10, HB 14 and 19. Weight for the 6" model is about 7 1/4 oz.  
 Price: . . . . . \$140.00

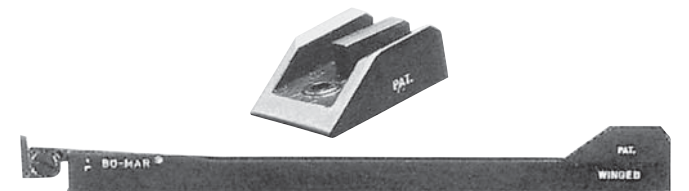

**Bomar Cover-Up Rib**

**BO-MAR COVER-UP RIB** Adjustable rear sight, winged front guards. Fits right over revolver's original front sight. For S&W 4" M-10HB, M-13, M-58, M-64 & 65, Ruger 4" models SDA-34, SDA-84, SS-34, SS-84, GF-34, GF-84.  
 Price: . . . . . \$130.00

# METALLIC SIGHTS

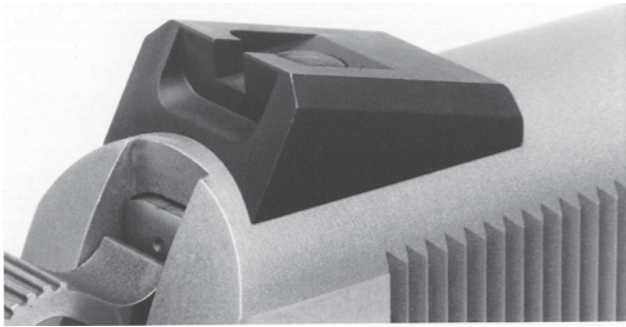

**Chip McCormick "Drop In"**

**CHIP MCCORMICK "DROP-IN" A** low mount sight that fits any 1911-style slide with a standard military-type dovetail sight cut (60x.290"). Dovetail front sights also available. From Chip McCormick Corp.

Price: ..... **\$47.95**

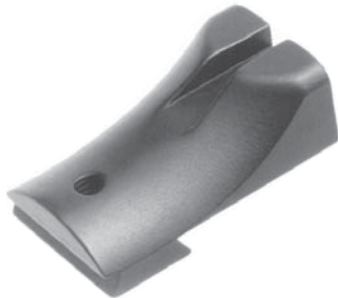

**Chip McCormick Fixed Sight**

**CHIP MCCORMICK FIXED SIGHTS** Same sight picture (.110" rear - .110" front) that's become the standard for pro combat shooters. Low mount design with rounded edges. For 1911-style pistols. May require slide machining for installation. From Chip McCormick Corp.

Price: ..... **\$24.95**

**C-MORE SIGHTS** Replacement front sight blades offered in two types and five styles. Made of Du Pont Acetal, they come in a set of five high-contrast colors: blue, green, pink, red and yellow. Easy to install. Patridge style for Colt Python (all barrels), Ruger Super Blackhawk (7 1/2"), Ruger Blackhawk (4 5/8"); ramp style for Python (all barrels), Blackhawk (4 5/8"), Super Blackhawk (7 1/2" and 10 1/2"). From C-More Systems.

Price: Per set ..... **\$19.95**

**G.G. & G. GHOST RINGS** Replaces the factory rear sight without gunsmithing. Black phosphate finish. Available for Colt M1911 and Commander, Beretta M92F, Glock, S&W, SIG Sauer.

Price: ..... **\$65.00**

**Heinie Slant Pro**

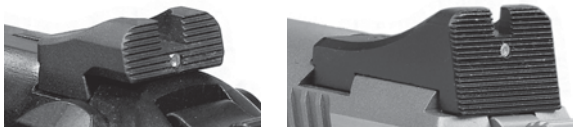

**HEINIE SLANT PRO** Made with a slight forward slant, the unique design of these rear sights is snag free for unimpeded draw from concealment. The combination of the slant and the rear serrations virtually eliminates glare. Made for most popular handguns. From Heinie Specialty Products.

Price: ..... **\$50.35 to \$122.80**

**HEINIE STRAIGHT EIGHT SIGHTS** Consists of one tritium dot in the front sight and a slightly smaller Tritium dot in the rear sight. When aligned correctly, an elongated 'eight' is created. The Tritium dots are green in color. Designed with the belief that the human eye can correct vertical alignment faster than horizontal. Available for most popular handguns. From Heinie Specialty Products.

Price: ..... **\$104.95 to \$122.80**

**HEINIE CROSS DOVETAIL FRONT SIGHTS** Made in a variety of heights, the standard dovetail is 60 degrees x .305" x .062" with a .002 taper. From Heinie Specialty Products.

Price: ..... **\$20.95 to \$47.20**

**JP GHOST RING** Replacement bead front, ghost ring rear for Glock and M1911 pistols. From JP Enterprises.

Price: ..... **\$79.95**

Price: Bo-Mar replacement leaf with JP dovetail front bead ..... **\$99.95**

**LES BAER CUSTOM ADJUSTABLE LOW MOUNT REAR SIGHT** Considered one of the top adjustable sights in the world for target shooting with 1911-style pistols. Available with Tritium inserts. From Les Baer Custom.

Price: ..... **\$49.00** (standard); **\$99.00** (tritium)

**LES BAER DELUXE FIXED COMBAT SIGHT** A tactical-style sight with a very low profile. Incorporates a no-snag design and has serrations on sides. For 1911-style pistols. Available with Tritium inserts for night shooting. From Les Baer Custom.  
Price: ..... **\$26.00** (standard); **\$67.00** (with Tritium)

**LES BAER DOVETAIL FRONT SIGHT** Blank dovetail sight machined from bar stock. Can be contoured to many different configurations to meet user's needs. Available with Tritium insert. From Les Baer Custom.

Price: ..... **\$17.00** (standard); **\$47.00** (with Tritium insert)

**LES BAER FIBER OPTIC FRONT SIGHT** Dovetail .330x65 degrees, .125" wide post, .185" high, .060" diameter. Red and green fiber optic. From Les Baer Custom.  
Price: ..... **\$24.00**

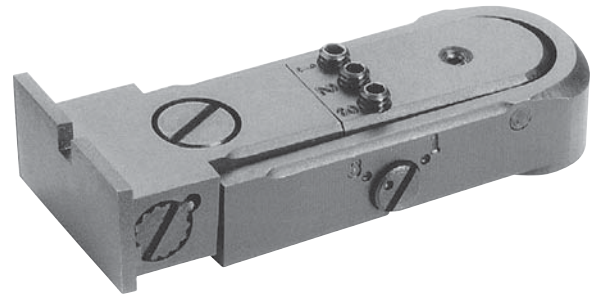

**Les Baer PPC-Style Adjustable Rear Sight**

**LES BAER PPC-STYLE ADJUSTABLE REAR SIGHT** Made for use with custom built 1911-style pistols, allows the user to preset three elevation adjustments for PPC-style shooting. Milling required for installation. Made from 4140 steel. From Les Baer Custom.  
Price: ..... **\$120.00**

**LES BAER DOVETAIL FRONT SIGHT WITH TRITIUM INSERT** This fully contoured and finished front sight comes ready for gunsmith installation. From Les Baer Custom.

Price: ..... **\$47.00**

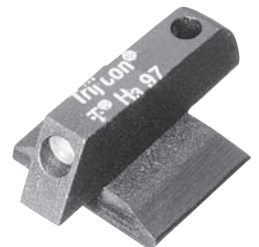

**Les Baer Dovetail**

**MMC TACTICAL ADJUSTABLE SIGHTS** Low-profile, snag free design. Twenty-two click positions for elevation, drift adjustable for windage. Machined from 4140 steel and heat treated to 40 RC. Tritium and non-tritium. Ten different configurations and colors. Three different finishes. For 1911s, all Glock, HK USP, S&W, Browning Hi-Power.

Price: Sight set, tritium ..... **\$144.92**

Price: Sight set, white outline or white dot ..... **\$99.90**

Price: Sight set, black ..... **\$93.90**

**MEPROLIGHT TRITIUM NIGHT SIGHTS** Replacement sight assemblies for low-light conditions. Available for pistols (fixed and adj.), rifles, shotguns. 12-year warranty for useable illumination, while non-TRU-DOT have a 5-year warranty. Distributed in American by Kimber.

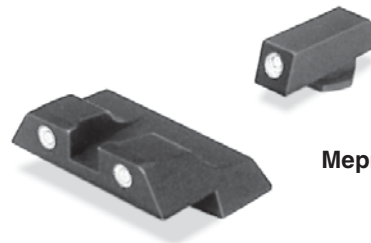

**Meprolight Glock**



**Meprolight Beretta**



# METALLIC SIGHTS

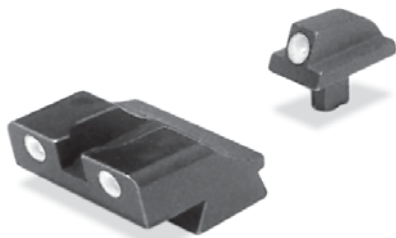

**Meprolight Colt**

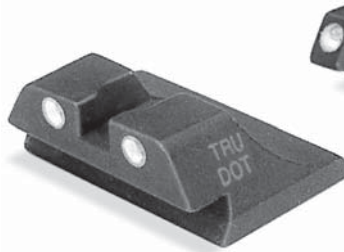

**Meprolight Ruger**

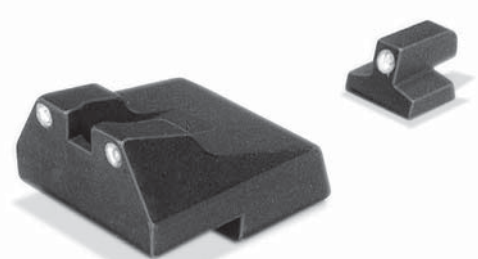

**Meprolight Smith & Wesson**

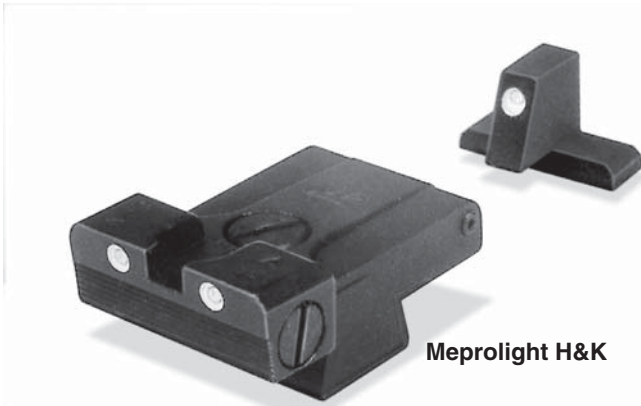

**Meprolight H&K**



**Meprolight Taurus**

Price: Kahr K9, K40, fixed, TRU-DOT.....	<b>\$100.00</b>
Price: Ruger P85, P89, P94, adjustable, TRU-DOT.....	<b>\$156.00</b>
Price: Ruger Mini-14R sights.....	<b>\$140.00</b>
Price: SIG Sauer P220, P225, P226, P228, adjustable, TRU-DOT.....	<b>\$156.00</b>
Price: Smith&Wesson autos, fixed or adjustable, TRU-DOT.....	<b>\$100.00</b>
Price: Taurus PT92, PT100, adjustable, TRU-DOT.....	<b>\$156.00</b>
Price: Walther P-99, fixed, TRU-DOT.....	<b>\$100.00</b>
Price: Shotgun bead.....	<b>\$32.00</b>
Price: Beretta M92, Cougar, Brigadier, fixed, TRU-DOT.....	<b>\$100.00</b>
Price: Browning Hi-Power, adjustable, TRU-DOT.....	<b>\$156.00</b>
Price: Colt M1911 Govt., adjustable, TRU-DOT.....	<b>\$156.00</b>

**MILLETT SERIES 100 REAR SIGHTS** All-steel highly visible, click adjustable. Blades in white outline, target black, silhouette, 3-dot. Fit most popular revolvers and autos.  
 Price:..... **\$51.77 to \$84.00**

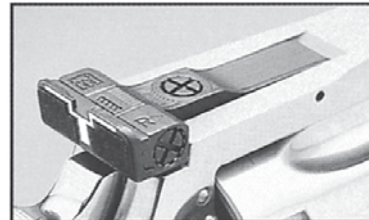

**Millet Colt**

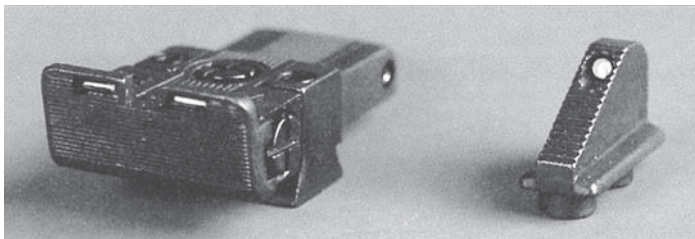

**Millet Tritium Night Sight**

**MILLETT BAR-DOT-BAR TRITIUM NIGHT SIGHTS** Replacement front and rear combos fit most automatics. Horizontal tritium bars on rear, dot front sight.  
 Price:..... **\$152.25**

**MILLETT BAR/DOT** Made with orange or white bar or dot for increased visibility. Available for Beretta 84, 85, 92S, 92SB, Browning, Colt Python & Trooper, Ruger GP 100, P85, Redhawk, Security Six.  
 Price:..... **\$14.99 to \$24.99**

**MILLETT 3-DOT SYSTEM SIGHTS** The 3-Dot System sights use a single white dot on the front blade and two dots flanking the rear notch. Fronts available in Dual-Crimp and Wide Stake-On styles, as well as special applications. Adjustable rear sight available for most popular auto pistols and revolvers including Browning Hi-Power, Colt 1911 Government and Ruger P85.  
 Price: Front, from..... **\$16.80**  
 Price: Adjustable rear..... **\$55.60**

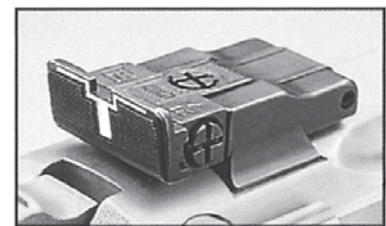

**Millet Ruger**

**MILLETT REVOLVER FRONT SIGHTS** All-steel replacement front sights with either white or orange bar. Easy to install. For Ruger GP-100, Redhawk, Security-Six, Police-Six, Speed-Six, Colt Trooper, Diamondback, King Cobra, Peacemaker, Python, Dan Wesson 22 and 15-2.  
 Price:..... **\$13.60 to \$16.00**

**MILLETT DUAL-CRIMP FRONT SIGHT** Replacement front sight for automatic pistols. Dual-Crimp uses an all-steel two-point hollow rivet system. Available in eight heights and four styles. Has a skirted base that covers the front sight pad. Easily installed with the Millet Installation Tool Set. Available in Blaze Orange Bar, White Bar, Serrated Ramp, Plain Post. Available in heights of .185", .200", .225", .275", .312", .340" and .410".  
 Price:..... **\$16.80**

**MILLETT STAKE-ON FRONT SIGHT** Replacement front sight for automatic pistols. Stake-On sights have skirted base that covers the front sight pad. Easily installed with the Millet Installation Tool Set. Available in seven heights and four styles-Blaze Orange Bar, White Bar, Serrated Ramp, Plain Post. Available for Glock 17L and 24, others.  
 Price:..... **\$16.80**

# METALLIC SIGHTS

**MILLETT ADJUSTABLE TARGET** Positive light-deflection serration and slant to eliminate glare and sharp edge sight notch. Audible "click" adjustments. For AMT Hardballer, Beretta 84, 85, 92S, 92SB, Browning Hi-Power, Colt 1911 Government and Gold Cup, Colt revolvers, Dan Wesson 15, 41, 44, Ruger revolvers, Glock 17, 17L, 19, 20, 21, 22, 23.

Price:..... **\$44.99**

**MILLETT ADJUSTABLE WHITE OUTLINE** Similar to the Target sight, except has a white outline on the blade to increase visibility. Available for the same handguns as the Target model, plus BRNO CZ-75/TZ-75/TA-90 without pin on front sight, and Ruger P85.

Price:..... **\$44.99 to \$49.99**

**OMEGA OUTLINE SIGHT BLADES** Replacement rear sight blades for Colt and Ruger single action guns and the Interarms Virginian Dragoon. Standard Outline available in gold or white notch outline on blue metal. From Omega Sales, Inc.

Price:..... **\$10.00**

**OMEGA MAVERICK SIGHT BLADES** Replacement "peep-sight" blades for Colt, Ruger SAs, Virginian Dragoon. Three models available-No. 1, Plain; No. 2, Single Bar; No. 3, Double Bar Rangefinder. From Omega Sales, Inc.

Price: Each..... **\$10.00**

**ONE RAGGED HOLE** Replacement rear sight ghost ring sight for Ruger handguns. Fits Blackhawks, Redhawks, Super Blackhawks, GP series and Mk. II target pistols with adjustable sights. From One Ragged Hole, Tallahassee, Florida.

Price:..... **NA**



**Pachmayr Accu-Set**

**PACHMAYR ACCU-SET** Low-profile, fully adjustable rear sight to be used with existing front sight. Available with target, white outline or 3-dot blade. Blue finish. Uses factory dovetail and locking screw. For Browning, Colt, Glock, SIG Sauer, S&W and Ruger autos. From Pachmayr.

Price:..... **\$59.98**

**P-T TRITIUM NIGHT SIGHTS** Self-luminous tritium sights for most popular handguns, Colt AR-15, H&K rifles and shotguns. Replacement handgun sight sets available in 3-Dot style (green/green, green/yellow, green/orange) with bold outlines around inserts; Bar-Dot available in green/green with or without white outline rear sight. Functional life exceeds 15 years. From Innovative Weaponry, Inc.

Price: Handgun sight sets..... **\$99.95**

Price: Rifle sight sets..... **\$99.95**

Price: Rifle, front only..... **\$49.95**

Price: Shotgun, front only..... **\$49.95**

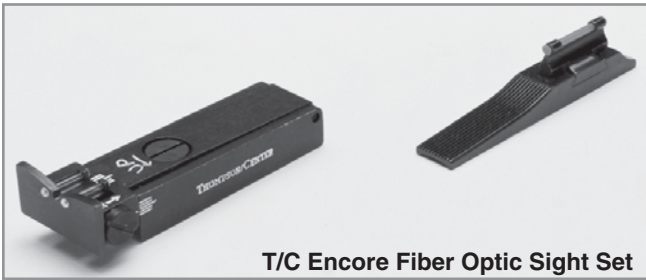

**T/C Encore Fiber Optic Sight Set**

**T/C ENCORE FIBER OPTIC SIGHT SETS** Click adjustable, steel rear sight and ramp-style front sight, both fitted with Tru-Glo™ fiber optics. Specifically-designed for the T/C Encore pistol series. From Thompson/Center Arms.

Price:..... **\$49.35**

**T/C ENCORE TARGET REAR SIGHT** Precision, steel construction with click adjustments (via knurled knobs) for windage and elevation. Models available with low, medium and high blades. From Thompson/Center Arms.

Price:..... **\$54.00**

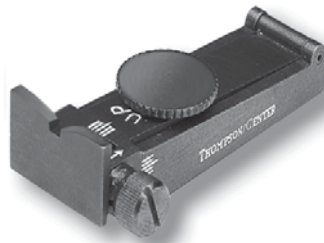

**T/C Encore Target Rear Sight**



**Trijicon Night Sight**

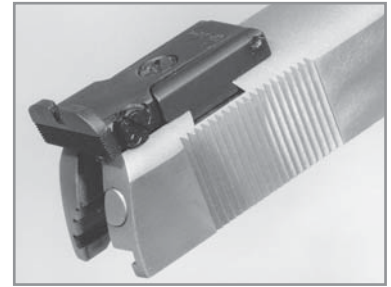

**Wichita Series 70/80 Sight**

**TRIJICON NIGHT SIGHTS** Three-dot night sight system uses tritium lamps in the front and rear sights. Tritium "lamps" are mounted in silicone rubber inside a metal cylinder. A polished crystal sapphire provides protection and clarity. Inlaid white outlines provide 3-dot aiming in daylight also. Available for most popular handguns including Glock 17, 19, 20, 21, 23, 24, 25, 26, 29, 30, H&K USP, Ruger P94, SIG P220, P225, 226, Colt 1911. Front and rear sets available. From Trijicon, Inc.

Price:..... **\$80.00 to \$299.00**

**TRIJICON 3-DOT** Self-luminous front iron night sight for the Ruger SP101.

Price:..... **\$50.00**

**WICHITA SERIES 70/80 SIGHT** Provides click windage and elevation adjustments with precise repeatability of settings. Sight blade is grooved and angled back at the top to reduce glare. Available in Low Mount Combat or Low Mount Target styles for Colt 45s and their copies, S&W 645, Hi-Power, CZ 75 and others.

Price: Rear sight, target or combat. **\$75.00**

Price: Front sight, Patridge or ramp. **\$18.00**

**WICHITA GRAND MASTER DELUXE RIBS** Ventilated rib has wings machined into it for better sight acquisition and is relieved for Mag-Na-Porting. Milled to accept Weaver see-thru-style rings. Made of stainless; front and rear sights blued. Has Wichita Multi-Range rear sight system, adjustable front sight. Made for revolvers with 6" barrel.

Price: Model 301S, 301B (adj. sight K frames with custom bbl. of 1" to 1.032" dia.

L and N frame with 1.062" to 1.100" dia. bbl.)..... **\$225.00**

Price: Model 303S, 303B (adj. sight K, L, N frames with factory barrel)..... **\$225.00**

**WICHITA MULTI-RANGE QUICK CHANGE SIGHTING SYSTEM** Multi-range rear sight can be pre-set to four positive repeatable range settings. Adjustable front sight allows compensation for changing lighting and weather conditions with just one front sight adjustment. Front sight comes with Lyman 17A Globe and set of apertures.

Price: Rear sight..... **\$125.00**

Price: Front, sight..... **\$95.00**

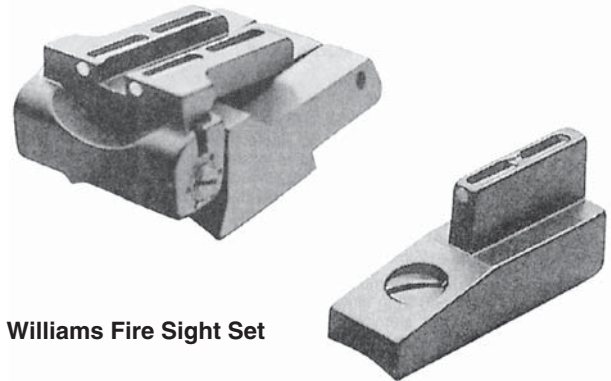

**Williams Fire Sight Set**

**WILLIAMS FIRE SIGHT SETS** Red fiber optic metallic sight replaces the original. Rear sight has two green fiber optic elements. Made of CNC-machined aluminum. Fits all Glocks, Ruger P-Series (except P-85), S&W 910, Colt Gov't. Model Series 80, Ruger GP 100 and Redhawk, and SIG Sauer (front only).

Price: Front and rear set..... **\$39.95**

Price: SIG Sauer front..... **\$22.95**

Price: Browning BuckMark sight set..... **\$44.95**

Price: Taurus PT111, PT140, PT145, PT1232, PT138..... **\$44.95**

Price: Ruger P Series, Glock, S&W 910, Colt Gov't. Series 80, Springfield XD..... **\$44.95**

**WILSON ADJUSTABLE REAR SIGHTS** Machined from steel, the click adjustment design requires simple cuts and no dovetails for installation. Available in several configurations: matte black standard blade with .128" notch; with .110" notch; with Tritium dots and .128" square or "U" shaped notch; and Combat Pyramid. From Wilson Combat.

Price:..... **\$24.95 to \$69.95**



# METALLIC SIGHTS

## Sight Attachments

**MERIT OPTICAL ATTACHMENT** For iron sight shooting with handgun or rifle. Instantly attached by rubber suction cup to prescription or shooting glasses. Swings aside. Aperture adjustable from .020" to .156".  
Price: ..... \$65.00

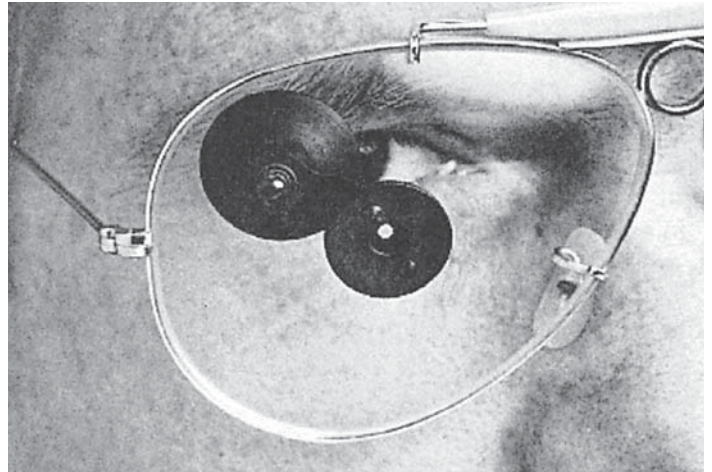

**Merit Optical Attachment**

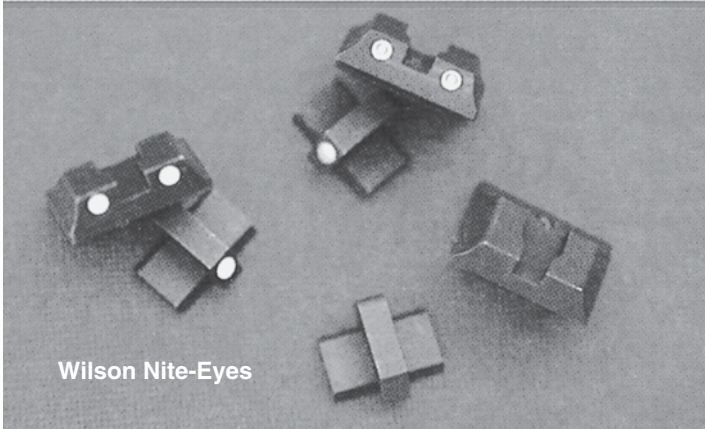

**Wilson Nite-Eyes**

**WILSON NITE-EYES SIGHTS** Low-profile, snag free design with green and yellow Tritium inserts. For 1911-style pistols. From Wilson Combat.  
Price: ..... \$119.95

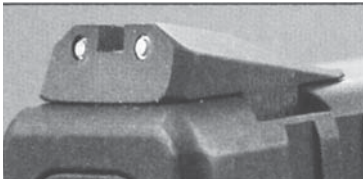

**WILSON TACTICAL COMBAT SIGHTS** Low-profile and snag-free in design, the sight employs the Combat Pyramid shape. For many 1911-style pistols and some Glock models. From Wilson Combat.  
Price: ..... \$139.95

# LASER SIGHTS



Alpec Mini Shot



Laseraim LA5X



Laseraim LAX

Maker and Model	Wave length (nm)	Beam Color	Lens	Operating Temp. (degrees F.)	Weight (ozs.)	Price	Other Data	
<b>ALPEC</b>								
Power Shot <sup>1</sup>	635	Red	Glass	NA	2.5	<b>\$199.95</b>	<sup>1</sup> Range 1000 yards. <sup>2</sup> Range 300 yards. Mini Shot II range 500 yards, output 650mm, <b>\$129.95</b> . <sup>3</sup> Range 300 yards; Laser Shot II 500 yards; Super Laser Shot 1000 yards. Black or stainless finish aluminum; removable pressure or push-button switch. Mounts for most handguns, many rifles and shotguns. From Alpec Team, Inc.	
Mini Shot <sup>2</sup>	670	Red	Glass	NA	2.5	<b>99.95</b>		
Laser Shot <sup>3</sup>	670	Red	Glass	NA	3.0	<b>99.95</b>		
<b>BEAMSHOT</b>								
1000 <sup>1</sup>	670	Red	Glass		3.8	<b>NA</b>	<sup>1</sup> Black or silver finish; adj. for windage and elevation; 300-yd. range; also M1000/S (500-yd. range), M1000/u (800-yd.). <sup>2</sup> Black finish; 300-, 500-, 800-yd. models. All come with removable touch pad switch, 5" cable. Mounts to fit virtually any firearm. From Quarton USA Co.	
3000 <sup>2</sup>	635/670	Red	Glass		2	<b>NA</b>		
1001/u	635	Red	Glass		3.8	<b>NA</b>		
780	780	Red	Glass		3.8	<b>NA</b>		
<b>BSA</b>								
LS650 <sup>1</sup>	N/A	Red	NA	NA	NA	<b>49.95</b>	<sup>1</sup> Comes with mounts for 22/air rifle and Weaver-style bases.	
<b>LASERAIM</b>								
LA10 Hotdot <sup>1</sup>					NA	<b>199.00</b>	<sup>1</sup> MOA dot at 100 yds; fits Weaver base. 3300-yd range; 2" dot at 100 yds.; rechargeable Nicad battery 41.5-mile range; 1" dot at 100 yds.; 20+ hrs. batt. life. <sup>2</sup> Laser projects 2" dot at 100 yds.; with rotary switch; with Hotdot <b>\$237.00</b> ; with Hotdot touch switch <b>\$357.00</b> . <sup>3</sup> For Glock 17-27; G1 Hotdot <b>\$299.00</b> ; price installed. <sup>10</sup> Fits std. Weaver base, no rings required; 6-MOA dot; seven brightness settings. All have w&e adj.; black or satin silver finish. From Laseraim Technologies, Inc.	
<b>Lasers</b>								
MA-35RB Mini Aimer <sup>2</sup>					1.0	<b>129.00</b>		
G1 Laser <sup>3</sup>					2.0	<b>229.00</b>		
<b>LASER DEVICES</b>								
BA-1 <sup>1</sup>	632	Red	Glass		2.4	<b>372.00</b>	<sup>1</sup> For S&W P99 semi-auto pistols; also BA-2, 5 oz., <b>\$339.00</b> . <sup>2</sup> For revolvers. <sup>3</sup> For HK, Walther P99. <sup>4</sup> For semi-autos. <sup>5</sup> For rifles; also FA-4/ULS, 2.5 oz., \$325.00. <sup>6</sup> For HK sub guns. <sup>7</sup> For military rifles. <sup>8</sup> For shotguns. <sup>9</sup> For SIG-Pro pistol. <sup>10</sup> Universal, semi-autos. All avail. with Magnum Power Point (650nM) or daytime-visible Super Power Point (632nM) diode. Infrared diodes avail. for law enforcement. From Laser Devices, Inc.	
BA-3 <sup>2</sup>	632	Red	Glass		3.3	<b>332.50</b>		
BA-5 <sup>3</sup>	632	Red	Glass		3.2	<b>372.00</b>		
Duty-Grade <sup>4</sup>	632	Red	Glass		3.5	<b>372.00</b>		
FA-4 <sup>5</sup>	632	Red	Glass		2.6	<b>358.00</b>		
LasTac <sup>1</sup>	632	Red	Glass		5.5	<b>298.00 to 477.00</b>		



# LASER SIGHTS

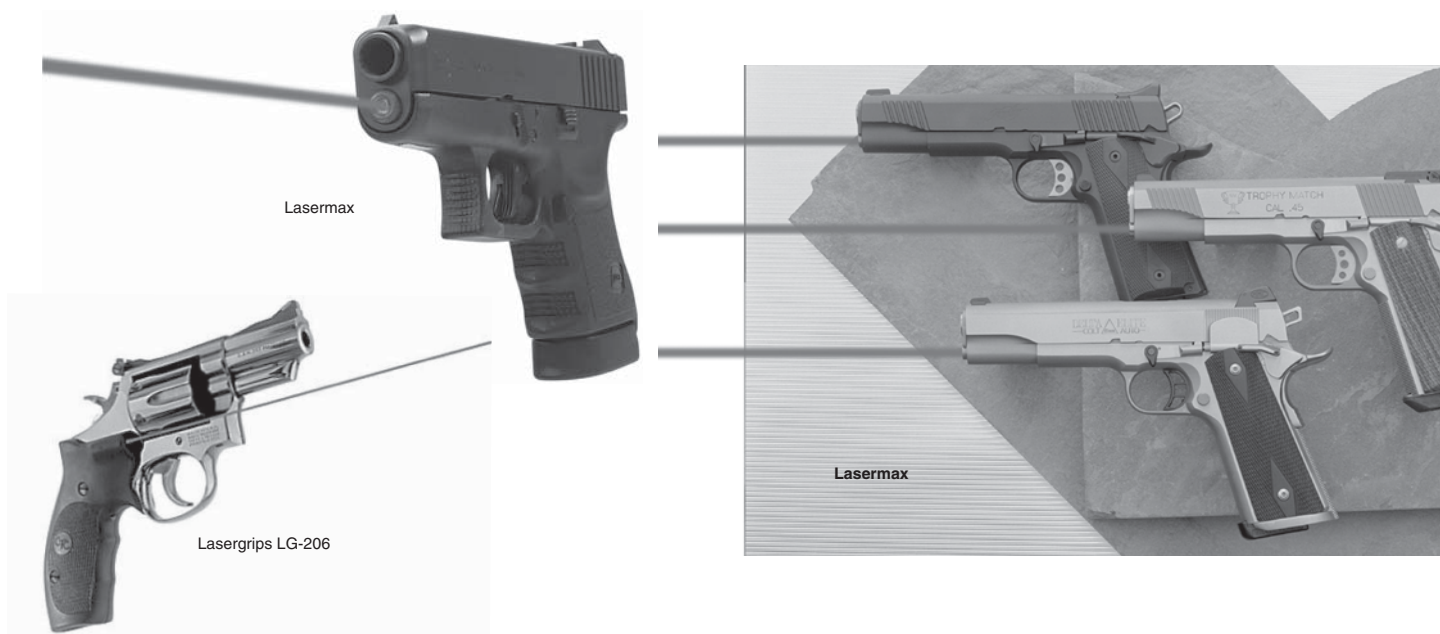

Maker and Model	Wave length (nm)	Beam Color	Lens	Operating Temp. (degrees F.)	Weight (ozs.)	Price	Other Data
<b>LASER DEVICES</b> (cont.)							
MP-5 <sup>6</sup>	632	Red	Glass		2.2	<b>495.00</b>	
MR-2 <sup>7</sup>	632	Red	Glass		6.3	<b>485.00</b>	
SA-2 <sup>8</sup>	632	Red	Glass		3.0	<b>360.00</b>	
SIG-Pro <sup>9</sup>	632	Red	Glass		2.6	<b>372.00</b>	
ULS-2001 <sup>10</sup>	632	Red	Glass		4.5	<b>210.95</b>	
Universal AR-2A	632	Red	Glass		4.5	<b>445.00</b>	
<b>LASERGRIPS</b>							
LG-201 <sup>1</sup>	633	Red-Orange	Glass	NA		<b>299.00</b>	Replaces existing grips with built-in laser high in the right grip panel. Integrated pressure sensitive pad in grip activates the laser. Also has master on/off switch. <sup>1</sup> For Colt 1911/Commander. <sup>2</sup> For all Glock models. Option on/off switch. Requires factory installation. <sup>3</sup> For S&W K, L, N frames, round or square butt (LG-207); <sup>4</sup> For Taurus small-frame revolvers. <sup>5</sup> For Ruger SP-101. <sup>6</sup> For SIG Sauer P226. From Crimson Trace Corp. <sup>7</sup> For Beretta 92/96. <sup>8</sup> For Ruger MK II. <sup>9</sup> For S&W J-frame. <sup>10</sup> For Sig Sauer P228/229. <sup>11</sup> For Colt 1911 full size, wraparound. <sup>12</sup> For Beretta 92/96, wraparound. <sup>13</sup> For Colt 1911 compact, wraparound. <sup>14</sup> For S&W J-frame, rubber.
LG-206 <sup>3</sup>	633	Red-Orange	Glass	NA		<b>229.00</b>	
LG-085 <sup>4</sup>	633	Red-Orange	Glass	NA		<b>229.00</b>	
LG-101 <sup>5</sup>	633	Red-Orange	Glass	NA		<b>229.00</b>	
LG-226 <sup>6</sup>	633	Red-Orange	Glass	NA		<b>229.00</b>	
GLS-630 <sup>2</sup>	633	Red-Orange	Glass	NA		<b>595.00</b>	
LG202 <sup>7</sup>	633	Red-Orange	Glass	NA		<b>299.00</b>	
LG203 <sup>8</sup>	633	Red-Orange	Glass	NA		<b>299.00</b>	
LG205 <sup>9</sup>	633	Red-Orange	Glass	NA		<b>299.00</b>	

# LASER SIGHTS



Laser Devices BA-5 on HK USP

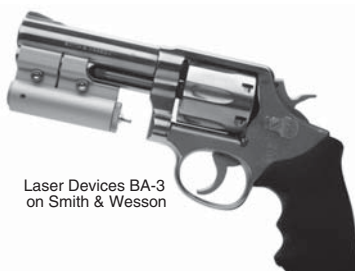

Laser Devices BA-3 on Smith & Wesson



Laser Devices Sig Pro Laser & Tactical Light



Laser Devices ULS 2001 with TLS 8R light



Laser Devices Duty Grade on Glock 20 pistol



Laser Devices Las/Tac on HK USP

Maker and Model	Wave length (nm)	Beam Color	Lens	Operating Temp. (degrees F.)	Weight (ozs.)	Price	Other Data
<b>LASERGRIPS (cont.)</b>							
LG229 <sup>10</sup>	633	Red-Orange	Glass	NA		<b>299.00</b>	
LG301 <sup>11</sup>	633	Red-Orange	Glass	NA		<b>329.00</b>	
LG302 <sup>12</sup>	633	Red-Orange	Glass	NA		<b>329.00</b>	
LG304 <sup>13</sup>	633	Red-Orange	Glass	NA		<b>329.00</b>	
LG305 <sup>14</sup>	633	Red-Orange	Glass	NA		<b>299.00</b>	
<b>LASERLYTE</b>							
LLX-0006-140/090 <sup>1</sup>	635/645	Red			1.4	<b>159.95</b>	<sup>1</sup> Dot/circle or dot/crosshair projection; black or stainless. <sup>2</sup> Also 635/645mm model. From Tac Star Laserlyte. Laser's insta in grip activates the laser. Also has master on/off switch.
WPL-0004-140/090 <sup>2</sup>	670	Red			1.2	<b>109.95</b>	
TPL-0004-140/090 <sup>2</sup>	670	Red			1.2	<b>109.95</b>	
T7S-0004-140 <sup>2</sup>	670	Red			0.8	<b>109.95</b>	
<b>LASERMAX</b>							
LMS-1000 Internal Guide Rod	635	Red-Orange	Glass	40-120	.25	<b>389.00</b>	Replaces the recoil spring guide rod; includes a customized takedown lever that serves as the laser's insta in grip activates the laser. Also has master on/off switch. For Glock, Smith & Wesson, Sigarms, Beretta, Colt, Kimber, Springfield Gov't. Model 1911, Heckler & Koch and select Taurus models. Installs in most pistols without gunsmithing. Battery life 1/2 hour to 2 hours in continuous use. From Laser Max.
<b>NIGHT STALKER</b>							
S0 Smart	635	Red	NA	NA	2.46	<b>515.00</b>	Waterproof; LCD panel displays power remaining; programmable blink rate; con stant or memory on. From Wilcox Industri in grip activates the laser. Also has master on/off switch.



# COMPENDIUM OF STATE LAWS GOVERNING FIREARMS

The following chart lists the main provisions of state firearms laws as of the date of publication. In addition to the state provisions, the purchase, sale, and, in certain circumstances, the possession and interstate transportation of firearms are regulated by the Federal Gun Control Act of 1968 as amended by the Firearms Owners' Protection Act of 1986. Also, cities and localities may have their own gun ordinances in addition to federal and state restrictions. Details may be obtained by contacting local law enforcement authorities or by consulting your state's firearms law digest compiled by the NRA Institute for Legislative Action.

STATE	GUN BAN	EXEMPTIONS TO NICS <sub>2</sub>	STATE WAITING PERIOD - NUMBER OF DAYS		LICENSE OR PERMIT TO PURCHASE or other prerequisite		REGISTRATION		RECORD OF SALE REPORTED TO STATE OR LOCAL GOVT.
			HANDGUNS	LONG GUNS	HANDGUNS	LONG GUNS	HANDGUNS	LONG GUNS	
Alabama	—	—	—	—	—	—	—	—	—
Alaska	—	RTC	—	—	—	—	—	—	—
Arizona	—	RTC	—	—	—	—	—	—	—
Arkansas	—	RTC <sub>3</sub>	—	—	—	—	—	—	—
California	X <sub>20</sub>	—	10 <sub>14</sub>	10 <sub>14,15</sub>	8, 23	—	X	24	X
Colorado	—	—	—	—	—	—	—	—	—
Connecticut	X <sub>20</sub>	—	14 <sub>14,15</sub>	14 <sub>14,15</sub>	X <sub>16, 23</sub>	—	—	24	X
Delaware	—	—	—	—	—	—	—	—	—
Florida	—	GRTC	3 <sub>14,15</sub>	—	—	—	—	—	—
Georgia	—	RTC	—	—	—	—	—	—	—
Hawaii	X <sub>20</sub>	L, RTC	—	—	X <sub>16, 23</sub>	X <sub>16</sub>	X <sub>12</sub>	X <sub>12</sub>	X
Idaho	—	RTC	—	—	—	—	—	—	—
Illinois	20	—	3	2	X <sub>16</sub>	X <sub>16</sub>	4	4	X
Indiana	—	RTC, O <sub>3</sub>	—	—	—	—	—	—	X
Iowa	—	L, RTC	—	—	X <sub>16</sub>	—	—	—	—
Kansas	—	—	1	—	1	—	1	—	1
Kentucky	—	RTC <sub>3</sub>	—	—	—	—	—	—	—
Louisiana	—	GRTC	—	—	—	—	—	—	—
Maine	—	—	—	—	—	—	—	—	—
Maryland	X <sub>20</sub>	O <sub>3</sub>	7 <sub>14</sub>	7 <sub>9,14</sub>	8, 23	—	—	—	X
Massachusetts	X <sub>20</sub>	GRTC	—	—	X <sub>16</sub>	X <sub>16</sub>	—	—	X
Michigan	—	O <sub>3</sub>	—	—	X <sub>16, 23</sub>	—	X	—	X
Minnesota	—	—	7 <sub>16</sub>	16	X <sub>16</sub>	X <sub>16</sub>	—	—	—
Mississippi	—	RTC <sub>3</sub>	—	—	—	—	—	—	—
Missouri	—	—	—	—	X <sub>16</sub>	—	—	—	X
Montana	—	RTC	—	—	—	—	—	—	—
Nebraska	—	L	—	—	X	—	—	—	—
Nevada	—	RTC	1	—	—	—	1	—	—
New Hampshire	—	—	—	—	—	—	—	—	—
New Jersey	X <sub>20</sub>	—	—	—	X <sub>16</sub>	X <sub>16</sub>	—	24	X
New Mexico	—	—	—	—	—	—	—	—	—
New York	X <sub>20</sub>	L, RTC	—	—	X <sub>16, 23</sub>	16	X	7	X
North Carolina	—	L, RTC	—	—	X <sub>16</sub>	—	—	—	X
North Dakota	—	RTC	—	—	—	—	—	—	—
Ohio	20	—	1	—	16	—	1	—	1
Oklahoma	—	—	—	—	—	—	—	—	—
Oregon	—	GRTC	—	—	—	—	—	—	X
Pennsylvania	—	—	—	—	—	—	—	—	X
Rhode Island	—	—	7	7	23	—	—	—	X
South Carolina	—	RTC	8	—	8	—	—	—	X
South Dakota	—	GRTC	2	—	—	—	—	—	X
Tennessee	—	—	—	—	—	—	—	—	—
Texas	—	RTC <sub>3</sub>	—	—	—	—	—	—	—
Utah	—	RTC	—	—	—	—	—	—	—
Vermont	—	—	—	—	—	—	—	—	—
Virginia	X <sub>20</sub>	—	1,8	—	1,8	—	—	—	1
Washington	—	O <sub>3</sub>	5 <sub>10</sub>	—	—	—	—	—	X
West Virginia	—	—	—	—	—	—	—	—	—
Wisconsin	—	—	2	—	—	—	—	—	—
Wyoming	—	RTC	—	—	—	—	—	—	—
District of Columbia	X <sub>20</sub>	L	—	—	X <sub>16</sub>	X <sub>16</sub>	X <sub>16</sub>	X	X

# COMPENDIUM OF STATE LAWS GOVERNING FIREARMS

Since state laws are subject to frequent change, this chart is not to be considered legal advice or a restatement of the law.

All fifty states have sportsmen's protections laws to halt harrassment.

STATE	STATE PROVISION FOR RIGHT-TO-CARRY CONCEALED	CARRYING OPENLY PROHIBITED	OWNER ID CARDS OR LICENSING	FIREARM RIGHTS CONSTITUTIONAL PROVISION	STATE FIREARMS PREEMPTION LAWS	RANGE PROTECTION LAW
Alabama	R	X <sub>11</sub>	—	X	X	X
Alaska	R <sub>19</sub>	—	—	X	—	X
Arizona	R	—	—	X	X	X
Arkansas	R	X <sub>5</sub>	—	X	X	X
California	L	X <sub>6</sub>	—	—	X	X
Colorado	R	25	—	X	X <sub>25</sub>	X
Connecticut	R	X	—	X	X <sub>17</sub>	X
Delaware	L	—	—	X	X	—
Florida	R	X	—	X	X	X
Georgia	R	X	—	X	X	X
Hawaii	L	X	X	X	—	—
Idaho	R	—	—	X	X	X
Illinois	D	X	X	X	—	X
Indiana	R	X	—	X	X <sub>18</sub>	X
Iowa	L	X	—	—	X	X
Kansas	D	1	—	X	—	X
Kentucky	R	—	—	X	X	X
Louisiana	R	—	—	X	X	X
Maine	R	—	—	X	X	X
Maryland	L	X	—	—	X	X
Massachusetts	L	X	X	X	X <sub>17</sub>	X
Michigan	R	X <sub>11</sub>	—	X	X	X
Minnesota	R	X	—	—	X	—
Mississippi	R	—	—	X	X	X
Missouri	R	—	—	X	X	X
Montana	R	—	—	X	X	X
Nebraska	D	—	—	X	—	—
Nevada	R	—	—	X	X	X
New Hampshire	R	—	—	X	X	X
New Jersey	L	X	X	—	X <sub>17</sub>	X
New Mexico	R	—	—	X	X	X
New York	L	X	X	—	X <sub>22</sub>	X
North Carolina	R	—	—	X	X	X
North Dakota	R	X <sub>6</sub>	—	X	X	X
Ohio	D	1	16	X	—	X
Oklahoma	R	X <sub>6</sub>	—	X	X	X
Oregon	R	—	—	X	X	X
Pennsylvania	R	X <sub>11</sub>	—	X	X	X
Rhode Island	L	X	—	X	X	X
South Carolina	R	X	—	X	X	X
South Dakota	R	—	—	X	X	X
Tennessee	R	X <sub>5</sub>	—	X	X	X
Texas	R	X	—	X	X	X
Utah	R	X <sub>6</sub>	—	X	X	X
Vermont	R <sub>19</sub>	X <sub>5</sub>	—	X	X	X
Virginia	R	—	—	X	X	X
Washington	R	X <sub>21</sub>	—	X	X	—
West Virginia	R	—	—	X	X	X
Wisconsin	D	—	—	X	X	X
Wyoming	R	—	—	X	X	X
District of Columbia	D	X	X	NA	—	—



# COMPENDIUM OF STATE LAWS GOVERNING FIREARMS

With over 20,000 "gun control" laws on the books in America, there are two challenges facing every gun owner. First, you owe it to yourself to become familiar with the federal laws on gun ownership. Only by knowing the laws can you avoid innocently breaking one.

Second, while federal legislation receives much more media attention, state legislatures and city councils make many more decisions regarding your right to own and carry firearms. NRA members and all gun owners must take extra care to be aware of anti-gun laws and ordinances at the state and local levels.

## Notes:

1. In certain cities or counties.
2. **National Instant Check System (NICS) exemption codes:**  
**RTC**-Carry Permit Holders Exempt From NICS  
**GRTC**-Holders of RTC Permits issued before November 30, 1998 exempt from NICS. Holders of more recent permits are not exempt.  
**L**-Holders of state licenses to possess or purchase or firearms ID cards exempt from NICS.  
**O**-Other, See Note 3.
3. **NICS exemption notes:** **Arkansas:** RTC permits issued prior to 11/30/98 and those issued on and after 4/1/99 qualify. Those issued between 11/1/98 and 3/31/99 do not qualify. **Indiana:** Personal protection, hunting and target permits all qualify for exemptions. **Kentucky:** RTC permits issued after July 15, 1998 and prior to November 30, 1998 are exempt. **Maryland:** There are no exemptions for handgun purchases. For long gun purchases, those holding RTC permits issued before November 30, 1998 are exempt. **Michigan:** No exemptions for handguns, license for long guns. **Mississippi:** Permits issued to security guards do not qualify. **Texas:** Texas Peace Officer License, TCLEOSE Card, is valid only if issued prior to November 30, 1998. **Washington:** RTC permits issued after July 1, 1996 and prior to November 30, 1998 are exempt.
4. Chicago only. No handgun not already registered may be possessed.
5. **Arkansas** prohibits carrying a firearm "with a purpose to employ it as a weapon against a person." **Tennessee** prohibits carrying "with the intent to go armed." **Vermont** prohibits carrying a firearm "with the intent or purpose of injuring another."
6. Loaded.
7. New York City only.
8. A permit is required to acquire another handgun before 30 days have elapsed following the acquisition of a handgun.
9. **Maryland** subjects purchases of "assault weapons" to a 7-day waiting period.
10. May be extended by police to 30 days in some circumstances. An individual not holding a driver's license must wait 90 days.
11. Carrying a handgun openly in a motor vehicle requires a license.
12. Every person arriving in **Hawaii** is required to register any firearm(s) brought into the State within 3 days of arrival of the person or firearm(s), whichever occurs later. Handguns purchased from licensed dealers must be registered within 5 days.
13. Concealed carry laws vary significantly between the states. Ratings reflect the real effect a state's particular laws have on the ability of citizens to carry firearms for self-defense.
14. Purchases from dealers only. **Maryland:** 7 business days. Purchasers of regulated firearms must undergo background checks performed by the State Police, either through a dealer or directly through the State Police.
15. The waiting period does not apply to a person holding a valid permit or license to carry a firearm. In **Connecticut**, a hunting license also exempts the holder for long gun purchasers. **California:** transfers of a long gun to a person's parent, child or grandparent are exempt from the waiting period.
16. **Connecticut:** A certificate of eligibility or a carry permit is required to obtain a handgun and a carry permit is required to transport a handgun outside your home. **District of Columbia:** No handgun may be possessed unless it was registered prior to Sept. 23, 1976 and re-registered by Feb. 5, 1977. A permit to purchase is required for a rifle or shotgun. **Hawaii:** Purchase permits, required for all firearms, may not be issued until 14 days after application. A handgun purchase permit is valid for 10 days, for one handgun; a long gun permit is valid for one year, for multiple long guns. **Illinois:** A Firearm Owner's Identification Card (FOI) is required to possess or purchase a firearm, must be issued to qualified applicants within 30 days, and is valid for 5 years. **Iowa:** A purchase permit is required for handguns, and is valid for one year, beginning three days after issuance. **Massachusetts:** Firearms and feeding devices for firearms are divided into classes. Depending on the class, a firearm identification card (FID) or class A license or class B license is required to possess, purchase, or carry a firearm, ammunition thereof, or firearm feeding device, or "large capacity feeding device." **Michigan:** A handgun purchaser must obtain a license to purchase from local law enforcement, and within 10 days present the license and handgun to obtain a certificate of inspection. **Minnesota:** A handgun transfer or carrying permit, or a 7-day waiting period and handgun transfer report, is required to purchase handguns or "assault weapons" from a dealer. A permit or transfer report must be issued to qualified applicants within 7 days. A permit is valid for one year, a transfer report for 30 days. **Missouri:** A purchase permit is required for a handgun, must be issued to qualified applicants within 7 days, and is valid for 30 days. **New Jersey:** Firearm owners must possess a FID, which must be issued to qualified applicants within 30 days. To purchase a handgun, a purchase permit, which must be issued within 30 days to qualified applicants and is valid for 90 days, is required. An FID is required to purchase long guns. **New York:** Purchase, possession and/or carrying of a handgun require a single license, which includes any restrictions made upon the bearer. New York City also requires a license for long guns. **North Carolina:** To purchase a handgun, a license or permit is required, which must be issued to qualified applicants within 30 days. **Ohio:** Some cities require a permit-to-purchase or firearm owner ID card.
17. Preemption through judicial ruling. Local regulation may be instituted in **Massachusetts** if ratified by the legislature.
18. Except Gary and East Chicago and local laws enacted before January, 1994.
19. **Vermont and Alaska** law respect your right to carry without a permit. Alaska also has a permit to carry system to establish reciprocity with other states.
20. "Assault weapons" are prohibited in **California, Connecticut, New Jersey and New York.** Some local jurisdictions in **Ohio** also ban "assault weapons." **Hawaii** prohibits "assault pistols." **California** bans "unsafe handguns." **Illinois:** Chicago, Evanston, Oak Park, Morton Grove, Winnetka, Wilmette, and Highland Park prohibit handguns; some cities prohibit other kinds of firearms. **Maryland** prohibits "assault pistols" and the sale or manufacture of any handgun manufactured after Jan. 1, 1985, that appears on the Handgun Roster. **Massachusetts:** It is unlawful to sell, transfer or possess "any assault weapon or large capacity feeding device" [more than 10 rounds] that was not legally possessed on September 13, 1994. **Ohio:** some cities prohibit handguns of certain magazine capacities. **Virginia** prohibits "Street Sweeper" shotguns. **The District of Columbia** prohibits new acquisition of handguns and any semi-automatic firearm capable of using a detachable ammunition magazine of more than 12 rounds capacity. (With respect to some of these laws and ordinances, individuals may retain prohibited firearms owned previously, with certain restrictions.)
21. Local jurisdictions may opt out of prohibition.
22. Preemption only applies to handguns.
23. Requires proof of safety training for purchase. **California:** Must have Handgun Safety Certificate receipt which is valid for five years. **Connecticut:** To receive certificate of eligibility, must complete a handgun safety course approved by the Commissioner of Public Safety. **Hawaii:** Must have completed an approved handgun safety course. **Maryland:** Must complete an approved handgun safety course. **Michigan:** A person must correctly answer 70% of the questions on a basic safety review questionnaire in order to obtain a license to purchase. **New York:** Some counties require a handgun safety training course to receive a license. **Rhode Island:** Must receive a state-issued handgun safety card.
24. "Assault weapon" registration. **California** had two dates by which assault weapons had to be registered or possession after such date would be considered a felony: March 31, 1992 for the named make and model firearms banned in the 1989 legislation and December 31, 2000 for the firearms meeting the definition of the "assault weapons in the 1999 legislation. In **Connecticut**, those firearms banned by specific make and model in the 1993 law had to be registered by October 1, 1994 or possession would be considered a felony. A recent law requires registration of additional guns by October 1, 2003. In **New Jersey**, any "assault weapon" not registered, licensed, or rendered inoperable pursuant to a state police certificate by May 1, 1991, is considered contraband.
25. Local governments cannot enact ordinances that prohibit the sale, purchase, or possession of a firearm. Municipalities cannot restrict a person's ability to travel into, through, or within their jurisdiction for hunting or personal protection. Local governments, including law enforcement agencies, cannot maintain a database of guns or gun owners. Municipalities may prohibit open carry in government buildings if such prohibition is clearly posted.

## Concealed carry codes:

- R: Right-to-Carry "Shall issue" or less restrictive discretionary permit system (Ala., Conn.) (See also note #21.)  
L: Right-to-Carry Limited by local authority's discretion over permit issuance.  
D: Right-to-Carry Denied, no permit system exists; concealed carry is prohibited.





# Guide to Right-to-Carry Reciprocity and Recognition



- **The right to self-defense neither begins nor ends at a state border.**
- **A law-abiding citizen does not suffer a character change by crossing a state line.**
- **An “unalienable right” is not determined by geographical boundaries.**
- **A patchwork of state laws regarding the carrying of firearms can make criminals out of honest folks, especially those who frequently must travel the states to earn a living.**
- **Using data for all 3,054 U.S. counties from 1977 to 1994, University of Chicago Prof. John Lott finds that for each additional year a concealed handgun law is in effect the murder rate declines by 3%, robberies by over 2%, and the rape rate by 2%.**

In spite of the truth of these statements and the fact that nearly half of all Americans live in states that allow a law-abiding citizen to carry a firearm concealed for personal protection, it has not been commonplace that these same citizens could carry their firearm across states lines. NRA-ILA is working to pass right-to-carry reciprocity laws granting permit holders the ability to carry their firearms legally while visiting or traveling beyond their home state.

In order to assist NRA Members in determining which states recognize their permits, NRA-ILA has created this guide. This guide is not to be considered as legal advice or a restatement of the law. It is important to remember that state carry laws vary considerably. Be sure to check with state and local authorities outside your home state for a complete listing of restrictions on carrying concealed in that state. Many states restrict carrying in bars, restaurants (where alcohol is served), establishments where packaged alcohol is sold, schools, colleges, universities, churches, parks, sporting events, correctional facilities, courthouses, federal and state government offices/buildings, banks, airport terminals, police stations, polling places, any posted private property restricting the carrying of concealed firearms, etc. In addition to state restrictions, federal law prohibits carrying on military bases, in national parks and the sterile area of airports. National Forests usually follow laws of the state wherein the forest is located.

**NOTE:** Alaska and Vermont allow the concealed carry of firearms without a permit. Vermont residents traveling to other states must first obtain a non-resident permit from that state—if available—prior to carrying concealed. Alaska still issues permits to those who want them, allowing them to benefit by recognition and reciprocity laws.

**NOTE TO READERS:** Right To Carry reciprocity and recognition between the various states is subject to frequent change through legislative action and regulatory interpretation. This information is the best available at the time of publication. This summary is not intended as legal advice or restatement of law.

Rev. 3/2004

## Right-to-Carry Reciprocity and Recognition, cont.

<b>Alabama</b>		Right-To-Carry Law Type: Reasonable May Issue
<b>Issuing Authority:</b>	County Sheriff	
<b>Contact agency for out of state permits:</b>	Permits not granted.	
<b>These states recognize your permit:</b>	Alaska, Colorado, Florida, Georgia, Idaho, Indiana, Kentucky, Michigan, Mississippi, Missouri, New Hampshire, North Carolina, North Dakota, Oklahoma, Utah, Tennessee, Vermont, Wyoming	
<b>This state recognizes permits from the following states:</b>	Alaska, Colorado, Florida, Georgia, Idaho, Indiana, Kentucky, Michigan, Mississippi, New Hampshire, North Carolina, North Dakota, Oklahoma, Utah, Tennessee, Wyoming	
<b>Cost &amp; Term of Permit:</b>	\$10	1 year
<b>Key Government Offices:</b>	Alabama Dept. of Public Safety 500 Dexter Ave. Montgomery, Alabama 36130 Phone: (334)242-4392 Email: info@dps.state.al.us	Attorney General Alabama State House 11 South Union Street, 3rd Floor Montgomery, Alabama 36130 Phone: 334-242-7300
	<a href="http://www.dps.state.al.us">http://www.dps.state.al.us</a>	
<b>Alaska</b>		Right-To-Carry Law Type: Shall Issue
<b>Issuing Authority:</b>	State Trooper	
<b>Contact agency for out of state permits:</b>	Permits not granted.	
<b>These states recognize your permit:</b>	Alabama, Arizona, Colorado, Delaware, Florida, Idaho, Indiana, Kentucky, Michigan, Missouri, Montana, New Hampshire, North Carolina, North Dakota, Oklahoma, South Dakota, Utah, Vermont, Virginia, Wyoming	
<b>This state recognizes permits from the following states:</b>	No permit required to carry concealed in Alaska.	
<b>Cost &amp; Term of Permit:</b>	\$99	5 years
<b>Key Government Offices:</b>	Alaska Concealed Handgun Permit Program 5700 East Tudor Road Anchorage, Alaska 99507 Phone: (907) 269-0392	
	<a href="http://www.dps.state.ak.us/ast/achp/">http://www.dps.state.ak.us/ast/achp/</a>	
<b>Arizona</b>		Right-To-Carry Law Type: Shall Issue
<b>Issuing Authority:</b>	Arizona Department of Public Safety	
<b>Contact agency for out of state permits:</b>	Arizona Department of Public Safety	
<b>These states recognize your permit:</b>	Alaska, Arkansas, Colorado, Delaware, Florida, Idaho, Indiana, Kentucky, Michigan, Missouri, Montana, North Carolina, North Dakota, Oklahoma, Tennessee, Texas, Utah, Vermont, Virginia	
<b>This state recognizes permits from the following states:</b>	Alaska, Arkansas, California, Colorado, Connecticut, Delaware, Florida, Iowa, Kentucky, Louisiana, Maryland, Massachusetts, Michigan, Minnesota, Missouri, Montana, Nevada, New Mexico, North Carolina, North Dakota, Oklahoma, Oregon, South Carolina, Tennessee, Texas, Utah, West Virginia, Wyoming	
<b>Cost &amp; Term of Permit:</b>	\$50	4 years
<b>Key Government Offices:</b>	Arizona Department of Public Safety Attn: Concealed Weapons Permit Unit P.O. Box 6488 Phoenix, Arizona 85005 Phone: (602) 256-6280 and (800) 256-6280 Fax: (602) 223-2928 Email: ccw@dps.state.az.us	Arizona Attorney General 1275 W. Washington Street Phoenix, Arizona 85007 Phone: (602) 542-4266 and (888) 377-6108
	<a href="http://www.dps.state.az.us/ccw/default.asp">http://www.dps.state.az.us/ccw/default.asp</a>	



## Right-to-Carry Reciprocity and Recognition, cont.

<b>Connecticut</b>		Right-To-Carry Law Type: Reasonable May Issue
<b>Issuing Authority:</b>	Department of Public Safety, Special Licenses & Firearms Unit	
<b>Contact agency for out of state permits:</b>	Department of Public Safety, Special Licenses & Firearms Unit	
<b>These states recognize your permit:</b>	Alaska, Arizona, Idaho, Indiana, Kentucky, Michigan, Missouri, Montana, Oklahoma, Tennessee, Utah, Vermont	
<b>This state recognizes permits from the following states:</b>	none	
<b>Cost &amp; Term of Permit:</b>	\$35.00 plus \$24.00 fingerprint processing fee	5 years
<b>Key Government Offices:</b>	Department of Public Safety 1111 Country Club Road Middletown, Connecticut 06450-9294 Phone: (860) 685-8000 Fax: (860) 685-8354 Email: <a href="mailto:DPS.Feedback@po.state.ct.us">DPS.Feedback@po.state.ct.us</a> <a href="http://www.state.ct.us/dps/slfu/index.html">http://www.state.ct.us/dps/slfu/index.html</a>	Attorney General 55 Elm Street Hartford, Connecticut 06106 Phone: 860-808-5318 Fax: 860 808-5387 Email: <a href="mailto:Attorney.General@po.state.ct.us">Attorney.General@po.state.ct.us</a>
<b>Delaware</b>		Right-To-Carry Law Type: Restrictive May Issue
<b>Issuing Authority:</b>	Prothonotary of Superior Court	
<b>Contact agency for out of state permits:</b>	Permits not granted.	
<b>These states recognize your permit:</b>	Alaska, Arizona, Florida, Idaho, Indiana, Kentucky, Michigan, Missouri, Montana, North Carolina, Oklahoma, Tennessee, Utah, Vermont	
<b>This state recognizes permits from the following states:</b>	Alaska, Arizona, Colorado, Florida, Michigan, North Carolina, North Dakota, Oklahoma, Tennessee, Utah	
<b>Cost &amp; Term of Permit:</b>	\$34.50 plus other fees	Initially 2 years, renewal for 3 years.
<b>Key Government Offices:</b>	Delaware State Police P.O. Box 430 Dover, Delaware 9903-0430 Phone: (302) 739-5900 <a href="http://www.state.de.us/dsp/">http://www.state.de.us/dsp/</a>	Attorney General Carvel State Office Building 820 N. French Street Wilmington, Delaware 19801 Email: <a href="mailto:Attorney.General@State.DE.US">Attorney.General@State.DE.US</a>
<b>Florida</b>		Right-To-Carry Law Type: Shall Issue
<b>Issuing Authority:</b>	Department of Agriculture and Consumer Services, Division of Licensing	
<b>Contact agency for out of state permits:</b>	Department of Agriculture and Consumer Services, Division of Licensing	
<b>These states recognize your permit:</b>	Alabama, Alaska, Arizona, Arkansas, Colorado, Delaware, Georgia, Idaho, Indiana, Kentucky, Louisiana, Michigan, Mississippi, Missouri, Montana, New Hampshire, North Carolina, North Dakota, Oklahoma, Pennsylvania, South Dakota, Tennessee, Texas, Utah, Vermont, Wyoming	
<b>This state recognizes permits from the following states:</b>	Alabama, Alaska, Arizona, Arkansas, Colorado, Delaware, Georgia, Idaho, Indiana, Kentucky, Louisiana, Michigan, Mississippi, Montana, New Hampshire, North Carolina, North Dakota*, Oklahoma, Pennsylvania, South Dakota*, Tennessee, Texas, Utah, Wyoming	
<b>Cost &amp; Term of Permit:</b>	Residents: \$75 plus fingerprinting fee, Renewal: \$65	5 years
<b>Key Government Offices:</b>	Florida Dept. of Agriculture and Consumer Services, Division of Licensing P.O. Box 6687 Tallahassee, Florida 32314-6687 Phone: (850) 488-5381 email: <a href="mailto:springb@doacs.state.fl.us">springb@doacs.state.fl.us</a> <a href="http://licgweb.doacs.state.fl.us/">http://licgweb.doacs.state.fl.us/</a>	Office of Attorney General State of Florida The Capital Tallahassee, Florida 32399-1050 Phone: 850-414-3300 Fax: 850-410-1630 email: <a href="mailto:ag@oag.state.fl.us">ag@oag.state.fl.us</a>

\*must be 21

## Right-to-Carry Reciprocity and Recognition, cont.

<b>Arkansas</b>		<b>Right-To-Carry Law Type: Shall Issue</b>
<b>Issuing Authority:</b>	State Police	
<b>Contact agency for out of state permits:</b>	Permits not granted.	
<b>These states recognize your permit:</b>	Alaska, Arizona, Florida, Idaho, Indiana, Kentucky, Michigan, Missouri, Montana, North Carolina, Oklahoma, South Carolina, South Dakota, Tennessee, Texas, Utah, Vermont	
<b>This state recognizes permits from the following states:</b>	Arizona, Florida, Kentucky, North Carolina, Oklahoma, South Carolina, Tennessee, Texas, Utah	
<b>Cost &amp; Term of Permit:</b>	\$115	4 Years
<b>Key Government Offices:</b>	Regulatory Services Division Attn: Arkansas State Police #1 State Police Plaza Drive Little Rock, Arkansas 72209-2971 Phone: 501-618-8627 Fax: 501-618-8647	Office of the Attorney General 200 Catlett-Prien Tower 323 Center Street Little Rock, Arkansas 72201 Phone: 501-682-1323 (1-800-448-3014) Email: oag@ag.state.ar.us
<a href="http://www.state.ar.us/chl/chl.html">www.state.ar.us/chl/chl.html</a>		

<b>California</b>		<b>Right-To-Carry Law Type: Restrictive May Issue</b>
<b>Issuing Authority:</b>	County Sheriff	
<b>Contact agency for out of state permits:</b>	Permits not granted.	
<b>These states recognize your permit:</b>	Alaska, Arizona, Idaho, Indiana, Kentucky, Michigan, Missouri, Montana, Oklahoma, Tennessee, Utah, Vermont	
<b>This state recognizes permits from the following states:</b>	none	
<b>Cost &amp; Term of Permit:</b>	varies	2 years maximum
<b>Key Government Offices:</b>	California Attorney General Attn: Department of Justice P.O. Box 944255 Sacramento, California 94244-2550 Phone: (916) 445-9555	
<a href="http://caag.state.ca.us/">http://caag.state.ca.us/</a>		

<b>Colorado</b>		<b>Right-To-Carry Law Type: Shall Issue</b>
<b>Issuing Authority:</b>	County Sheriff	
<b>Contact agency for out of state permits:</b>	Permits not granted.	
<b>These states recognize your permit:</b>	Alabama, Alaska, Arizona, Florida, Georgia, Idaho, Indiana, Kentucky, Michigan, Missouri, Montana, New Hampshire, North Carolina, Oklahoma, South Dakota, Tennessee, Utah, Vermont, Wyoming	
<b>This state recognizes permits from the following states:</b>	Alabama, Alaska, Arizona, Florida, Georgia, Idaho, Iowa, Indiana, Kentucky, Michigan, Montana, New Hampshire, North Carolina, Oklahoma, South Dakota, Tennessee, Utah, Wyoming	
<b>Cost &amp; Term of Permit:</b>	No more than \$100	5 years
<b>Key Government Offices:</b>	Attorney General 1525 Sherman 5th Floor Denver, Colorado 80203 Phone: (303) 866-4500 Fax: (303) 866-5691 Email: attorney.general@state.co.us	Colorado Bureau of Investigation 690 Kipling St. Suite 3000 Denver, Colorado 80215 Phone: (303) 239-5850 Email: james.spoden@cdps.state.co.us
<a href="http://ebi.state.co.us/ccw/reciprocity.asp">http://ebi.state.co.us/ccw/reciprocity.asp</a>		



## Right-to-Carry Reciprocity and Recognition, cont.

<b>Georgia</b>	<b>Right-To-Carry Law Type: Shall Issue</b>		
<b>Issuing Authority:</b>	County Probate Judge		
<b>Contact agency for out of state permits:</b>	Permits not granted.		
<b>These states recognize your permit:</b>	Alabama, Alaska, Arizona, Colorado, Florida, Idaho, Indiana, Kentucky, Michigan, Missouri, Montana, New Hampshire, North Carolina, Oklahoma, Pennsylvania, South Dakota, Tennessee, Utah, Vermont, Wyoming		
<b>This state recognizes permits from the following states:</b>	Alabama, Colorado, Florida, Idaho, Indiana, Kentucky, Michigan, Montana, New Hampshire, North Carolina, Pennsylvania, South Dakota, Tennessee, Wyoming		
<b>Cost &amp; Term of Permit:</b>	\$24 to GBI and additional fee set by County. <span style="float: right;">5 years</span>		
<b>Key Government Offices:</b>	<table style="width: 100%; border: none;"> <tr> <td style="width: 50%; border: none; vertical-align: top;">                     Georgia Bureau of Investigation                      P.O. Box 370748                      Decatur, Georgia 30037-0748                      Phone: (404) 244-2501                 </td> <td style="width: 50%; border: none; vertical-align: top;">                     Georgia Attorney General                      40 Capitol Square, SW                      Atlanta, Georgia 30334-1300                      Phone: 404-656-3300                 </td> </tr> </table>	Georgia Bureau of Investigation P.O. Box 370748 Decatur, Georgia 30037-0748 Phone: (404) 244-2501	Georgia Attorney General 40 Capitol Square, SW Atlanta, Georgia 30334-1300 Phone: 404-656-3300
Georgia Bureau of Investigation P.O. Box 370748 Decatur, Georgia 30037-0748 Phone: (404) 244-2501	Georgia Attorney General 40 Capitol Square, SW Atlanta, Georgia 30334-1300 Phone: 404-656-3300		
	<a href="http://www.ganet.org/ago/">http://www.ganet.org/ago/</a>		

<b>Hawaii</b>	<b>Right-To-Carry Law Type: Restrictive May Issue</b>		
<b>Issuing Authority:</b>	Chief of Police		
<b>Contact agency for out of state permits:</b>	Permits not granted.		
<b>These states recognize your permit:</b>	Alaska, Idaho, Indiana, Kentucky, Michigan, Missouri, Montana, Oklahoma, Tennessee, Utah, Vermont		
<b>This state recognizes permits from the following states:</b>	none		
<b>Cost &amp; Term of Permit:</b>	varies <span style="float: right;">varies</span>		
<b>Key Government Offices:</b>	<table style="width: 100%; border: none;"> <tr> <td style="width: 50%; border: none; vertical-align: top;">                     Honolulu Police Department Attn: Firearms Division                      801 S. Beretania                      Honolulu, Hawaii                      Phone: 808-529-3371, Fax: 808-529-3525                      hpd@honolulupd.org  <a href="http://www.honolulupd.org/service/gunlaw/htm">http://www.honolulupd.org/service/gunlaw/htm</a> </td> <td style="width: 50%; border: none; vertical-align: top;">                     Attorney General                      Department of the Attorney General                      425 Queen Street                      Honolulu, Hawaii 96813                 </td> </tr> </table>	Honolulu Police Department Attn: Firearms Division 801 S. Beretania Honolulu, Hawaii Phone: 808-529-3371, Fax: 808-529-3525 hpd@honolulupd.org <a href="http://www.honolulupd.org/service/gunlaw/htm">http://www.honolulupd.org/service/gunlaw/htm</a>	Attorney General Department of the Attorney General 425 Queen Street Honolulu, Hawaii 96813
Honolulu Police Department Attn: Firearms Division 801 S. Beretania Honolulu, Hawaii Phone: 808-529-3371, Fax: 808-529-3525 hpd@honolulupd.org <a href="http://www.honolulupd.org/service/gunlaw/htm">http://www.honolulupd.org/service/gunlaw/htm</a>	Attorney General Department of the Attorney General 425 Queen Street Honolulu, Hawaii 96813		
	<a href="http://www.hawaii.gov/ag/index.html">http://www.hawaii.gov/ag/index.html</a>		

<b>Idaho</b>	<b>Right-To-Carry Law Type: Shall Issue</b>		
<b>Issuing Authority:</b>	County Sheriff		
<b>Contact agency for out of state permits:</b>	Any Sheriffs' Department		
<b>These states recognize your permit:</b>	Alabama, Alaska, Colorado, Florida, Georgia, Indiana, Kentucky, Michigan, Missouri, Montana, New Hampshire, North Carolina, North Dakota, Oklahoma, Tennessee, Utah, Vermont, Virginia, Wyoming		
<b>This state recognizes permits from the following states:</b>	All state permits		
<b>Cost &amp; Term of Permit:</b>	\$20 plus fingerprinting fee <span style="float: right;">4 years</span>		
<b>Key Government Offices:</b>	<table style="width: 100%; border: none;"> <tr> <td style="width: 50%; border: none; vertical-align: top;">                     Idaho Department of Law Enforcement                      700 S. Stratford Dr                      P.O. Box 700                      Meridian, Idaho 83680-0700                      Phone: (208)884-7000                 </td> <td style="width: 50%; border: none; vertical-align: top;">                     Idaho Attorney General                      700 W. Jefferson Street                      P.O. Box 83720                      Boise, Idaho 83720-0010                      Phone: (208) 334-2400                      Fax: (208) 334-2530                 </td> </tr> </table>	Idaho Department of Law Enforcement 700 S. Stratford Dr P.O. Box 700 Meridian, Idaho 83680-0700 Phone: (208)884-7000	Idaho Attorney General 700 W. Jefferson Street P.O. Box 83720 Boise, Idaho 83720-0010 Phone: (208) 334-2400 Fax: (208) 334-2530
Idaho Department of Law Enforcement 700 S. Stratford Dr P.O. Box 700 Meridian, Idaho 83680-0700 Phone: (208)884-7000	Idaho Attorney General 700 W. Jefferson Street P.O. Box 83720 Boise, Idaho 83720-0010 Phone: (208) 334-2400 Fax: (208) 334-2530		
	<a href="http://www.state.id.us/dle/dle.htm">http://www.state.id.us/dle/dle.htm</a>		

## Right-to-Carry Reciprocity and Recognition, cont.

<b>Illinois</b>		<b>Right-To-Carry Law Type: Non-Issue</b>
<b>Issuing Authority:</b>	Permits Not Available	
<b>Contact agency for out of state permits:</b>	Permits not granted.	
<b>These states recognize your permit:</b>	none	
<b>This state recognizes permits from the following states:</b>	none	
<b>Cost &amp; Term of Permit:</b>	n/a	n/a
<b>Key Government Offices:</b>	Illinois State Police P.O. Box 19461 Springfield, Illinois 62794-9461 Phone: 217-782-7263 Fax: 217-785-2821  <a href="http://www.state.il.us/isp/isphpage.htm">http://www.state.il.us/isp/isphpage.htm</a>	Attorney General 500 South Second St. Springfield, Illinois 62706 Phone: (217) 782-1090 Email: attorney_general@state.il.us
<b>Indiana</b>		<b>Right-To-Carry Law Type: Shall Issue</b>
<b>Issuing Authority:</b>	State Police through Chief Law Enforcement Officer of Municipality	
<b>Contact agency for out of state permits:</b>	Permits not granted.	
<b>These states recognize your permit:</b>	Alabama, Alaska, Colorado, Florida, Georgia, Idaho, Kentucky, Michigan, Missouri, Montana, New Hampshire, North Carolina, North Dakota, Oklahoma, South Dakota, Tennessee, Utah, Vermont, Wyoming	
<b>This state recognizes permits from the following states:</b>	All state permits recognized for non-Indiana residents.	
<b>Cost &amp; Term of Permit:</b>	\$30	4 years
<b>Key Government Offices:</b>	State Police 100 North Senate Avenue Indiana Government Center North, 3rd Floor Indianapolis, Indiana 46204-2259 Phone: (317) 232-8200  <a href="http://www.state.in.us/isp/">http://www.state.in.us/isp/</a>	Indiana Attorney General State House, Room 219 Indianapolis, Indiana 46204 Phone: (317) 232 - 6201
<b>Iowa</b>		<b>Right-To-Carry Law Type: Reasonable May Issue</b>
<b>Issuing Authority:</b>	Sheriff for residents, Commissioner of Public Safety for non residents	
<b>Contact agency for out of state permits:</b>	Commissioner of Public Safety	
<b>These states recognize your permit:</b>	Alaska, Arizona, Idaho, Indiana, Kentucky, Michigan, Missouri, Montana, Oklahoma, Tennessee, Utah, Vermont	
<b>This state recognizes permits from the following states:</b>	none	
<b>Cost &amp; Term of Permit:</b>	\$10 for permit	1 year
<b>Key Government Offices:</b>	Iowa Department of Public Safety Wallace State Office Building Des Moines, Iowa 50319 Phone: (515) 281-3211 Email: webteam@dps.state.ia.us  <a href="http://www.state.ia.us/government/dps/index.html">http://www.state.ia.us/government/dps/index.html</a>	Attorney General 1305 E. Walnut Street Des Moines, Iowa 50319 Phone: 515-281-5164 Fax: 515-281-4209 Email: webteam@ag.state.ia.us



## Right-to-Carry Reciprocity and Recognition, cont.

<b>Kansas</b>		Right-To-Carry Law Type: Non-Issue
<b>Issuing Authority:</b>	Permits Not Available	
<b>Contact agency for out of state permits:</b>	Permits Not Granted.	
<b>These states recognize your permit:</b>	none	
<b>This state recognizes permits from the following states:</b>	none	
<b>Cost &amp; Term of Permit:</b>	n/a	n/a
<b>Key Government Offices:</b>	Attorney General 301 S.W. 10th Avenue Topeka, Kansas 66612-1597 Phone: (785) 296-2215 Fax: (785) 296-6296 Email: GENERAL@at01po.wpo.state.ks.us <a href="http://www.ink.org/public/ksag/">http://www.ink.org/public/ksag/</a>	Highway Patrol General Headquarters 122 SW 7th Street Topeka, Kansas 66603-3847 Phone: 785-296-6800 Fax: 785-296-3049
<b>Kentucky</b>		Right-To-Carry Law Type: Shall Issue
<b>Issuing Authority:</b>	State Police	
<b>Contact agency for out of state permits:</b>	Permits not granted.	
<b>These states recognize your permit:</b>	Alabama, Alaska, Arizona, Arkansas, Colorado, Florida, Georgia, Idaho, Indiana, Louisiana, Michigan, Mississippi, Missouri, Montana, New Hampshire, North Carolina, North Dakota, Oklahoma, South Dakota, Pennsylvania, Tennessee, Texas, Utah, West Virginia, Vermont, Wyoming	
<b>This state recognizes permits from the following states:</b>	All state permits recognized.	
<b>Cost &amp; Term of Permit:</b>	\$60	5 years
<b>Key Government Offices:</b>	Kentucky State Police 919 Versailles Road Frankfort, Kentucky 40601 Phone: (502) 227-8725 <a href="http://www.kentuckystatepolice.org/conceal.htm#recip">http://www.kentuckystatepolice.org/conceal.htm#recip</a>	Office of the Kentucky Attorney General Frankfort, Kentucky 40601 Phone: (502) 696-5300
<b>Louisiana</b>		Right-To-Carry Law Type: Shall Issue
<b>Issuing Authority:</b>	Department of Public Safety & Corrections	
<b>Contact agency for out of state permits:</b>	Permits not granted.	
<b>These states recognize your permit:</b>	Alaska, Arizona, Florida, Idaho, Indiana, Kentucky, Michigan, Minnesota, Missouri, Montana, Oklahoma, Tennessee, Texas, Utah, Vermont, Virginia, Wyoming	
<b>This state recognizes permits from the following states:</b>	Florida, Kentucky, Tennessee, Texas, Wyoming	
<b>Cost &amp; Term of Permit:</b>	\$50 for 2 year permit, \$100 for 4 year permit.	2 years or 4 years
<b>Key Government Offices:</b>	Louisiana State Police/Department of Public Safety P.O. Box 66614 Baton Rouge, Louisiana 70896-6614 Phone: 225-925-4239 Fax: 225-925-3717 Email: concealed-handguns@dps.state.la.us <a href="http://www.lsp.org/handguns">http://www.lsp.org/handguns</a>	Louisiana Attorney General State Capitol, 22nd Floor P.O. Box 940005 Baton Rouge, Louisiana 70804-9005 Phone: (225) 342-7013 Fax: (225) 342-7335 <a href="http://www.ag.state.la.us">http://www.ag.state.la.us</a>

## Right-to-Carry Reciprocity and Recognition, cont.

<b>Maine</b>		Right-To-Carry Law Type: Shall Issue
<b>Issuing Authority:</b>	Dept of Public Safety, Maine State Police, Licensing Division	
<b>Contact agency for out of state permits:</b>	Chief of State Police	
<b>These states recognize your permit:</b>	Alaska, Idaho, Indiana, Kentucky, Michigan, Missouri, Oklahoma, Tennessee, Utah, Vermont	
<b>This state recognizes permits from the following states:</b>	none	
<b>Cost &amp; Term of Permit:</b>	Residents: new \$35. renewal \$20. Non residents: new & renewal \$60.	4 years
<b>Key Government Offices:</b>	Department of Public Safety Maine State Police, Licensing Division 164 State House Station Augusta, Maine 04333-0164 Phone: (207) 624-8775  <a href="http://www.state.me.us.dps/msp">http://www.state.me.us.dps/msp</a>	Attorney General 6 State House Station Augusta, Maine 04333 Phone: (207) 626-8800 <a href="http://www.me.state.us.ag/homepage.htm">http://www.me.state.us.ag/homepage.htm</a>
<b>Maryland</b>		Right-To-Carry Law Type: Restrictive May Issue
<b>Issuing Authority:</b>	Superintendent of State Police	
<b>Contact agency for out of state permits:</b>	Superintendent of State Police	
<b>These states recognize your permit:</b>	Alaska, Arizona, Idaho, Indiana, Kentucky, Michigan, Missouri, Montana, Oklahoma, Tennessee, Utah, Vermont	
<b>This state recognizes permits from the following states:</b>	none	
<b>Cost &amp; Term of Permit:</b>	New \$117 Renewal \$74	2 years
<b>Key Government Offices:</b>	Maryland State Police Attn: Handgun Permit Section 7751 Washington Blvd Jessup, Maryland 20794 Phone: (410) 79-0191, (800) 525-5555  <a href="http://www.mdsp.maryland.gov/mdsp/downloads/licensingapplications">http://www.mdsp.maryland.gov/mdsp/downloads/licensingapplications</a>	Attorney General 200 St. Paul Place Baltimore, Maryland 21202 Phone: (410) 576-6300 Fax: (410) 576-6447
<b>Massachusetts</b>		Right-To-Carry Law Type: Restrictive May Issue
<b>Issuing Authority:</b>	Department of State Police, Firearms Record Bureau	
<b>Contact agency for out of state permits:</b>	Permits are technically available for non-residents, but are rarely granted.	
<b>These states recognize your permit:</b>	Alaska, Arizona, Idaho, Indiana, Kentucky, Michigan, Missouri, Montana, Oklahoma, Tennessee, Utah, Vermont	
<b>This state recognizes permits from the following states:</b>	none	
<b>Cost &amp; Term of Permit:</b>	Residents and Non-Residents: \$100.	Residents: 4 years. Non res.: 1 year.
<b>Key Government Offices:</b>	Firearms Records Bureau Attn: Firearms License 200 Arlington Street Suite 2200 Chelsea, Massachusetts 02150 Phone: (617) 660-4780  <a href="http://www.state.ma.us/msp/firearms/index.htm">http://www.state.ma.us/msp/firearms/index.htm</a>	Massachusetts State Police 470 Worcester Road Framingham, Massachusetts 01702 Phone: (508) 820-2300 Email: <a href="mailto:msp.webmaster@pol.state.ma.us">msp.webmaster@pol.state.ma.us</a>



## Right-to-Carry Reciprocity and Recognition, cont.

<b>Michigan</b>	<b>Right-To-Carry Law Type: Shall Issue</b>		
<b>Issuing Authority:</b>	County Gun Board/Sheriff		
<b>Contact agency for out of state permits:</b>	Permits not granted.		
<b>These states recognize your permit:</b>	Alabama, Alaska, Arizona, Colorado, Delaware, Florida, Georgia, Idaho, Indiana, Kentucky, Minnesota, Montana, Missouri, New Hampshire, North Carolina, North Dakota, Oklahoma, Pennsylvania, South Dakota, Tennessee, Utah, Vermont, Virginia, Wyoming		
<b>This state recognizes permits from the following states:</b>	All state permits recognized, as long as permit holder is resident of issuing state.		
<b>Cost &amp; Term of Permit:</b>	\$105 New and renewal. <span style="float: right;">5 years</span>		
<b>Key Government Offices:</b>	<table style="width: 100%; border: none;"> <tr> <td style="width: 50%; border: none; vertical-align: top;">                     Michigan Department of State Police                      714 S. Harrison Road                      East Lansing, Michigan 48823                      Phone: (517) 332-2521                 </td> <td style="width: 50%; border: none; vertical-align: top;">                     Michigan Attorney General                      P.O. Box 30212                      Lansing, Michigan 48909                      Phone: (517) 373-1110                      Fax: (517) 241-1850  <a href="http://www.ag.state.mi.us">http://www.ag.state.mi.us</a> </td> </tr> </table>	Michigan Department of State Police 714 S. Harrison Road East Lansing, Michigan 48823 Phone: (517) 332-2521	Michigan Attorney General P.O. Box 30212 Lansing, Michigan 48909 Phone: (517) 373-1110 Fax: (517) 241-1850 <a href="http://www.ag.state.mi.us">http://www.ag.state.mi.us</a>
Michigan Department of State Police 714 S. Harrison Road East Lansing, Michigan 48823 Phone: (517) 332-2521	Michigan Attorney General P.O. Box 30212 Lansing, Michigan 48909 Phone: (517) 373-1110 Fax: (517) 241-1850 <a href="http://www.ag.state.mi.us">http://www.ag.state.mi.us</a>		
	<a href="http://www.michigan.gov/msp">http://www.michigan.gov/msp</a>		

<b>Minnesota</b>	<b>Right-To-Carry Law Type: Shall Issue</b>		
<b>Issuing Authority:</b>	Chief of Police/County Sheriff		
<b>Contact agency for out of state permits:</b>	Any Minnesota County Sheriff		
<b>These states recognize your permit:</b>	Alaska, Arizona, Idaho, Indiana, Kentucky, Michigan, Missouri, Montana, Oklahoma, Tennessee, Utah, Vermont		
<b>This state recognizes permits from the following states:</b>	Michigan, Louisiana, Wyoming		
<b>Cost &amp; Term of Permit:</b>	Not to exceed \$100. <span style="float: right;">5 years</span>		
<b>Key Government Offices:</b>	<table style="width: 100%; border: none;"> <tr> <td style="width: 50%; border: none; vertical-align: top;">                     Minnesota Department of Public Safety                      444 Cedar Street                      Saint Paul, Minnesota 55101                      Phone: (651) 282-6565  <a href="mailto:bca.permitstocarry@state.mn.us">bca.permitstocarry@state.mn.us</a> </td> <td style="width: 50%; border: none; vertical-align: top;">                     Minnesota Attorney General                      102 State Capitol                      St. Paul, Minnesota 55155                      Phone: (651) 296-6196                      Fax: (651) 297-4193  <a href="http://www.ag.state.mn.us">http://www.ag.state.mn.us</a> </td> </tr> </table>	Minnesota Department of Public Safety 444 Cedar Street Saint Paul, Minnesota 55101 Phone: (651) 282-6565 <a href="mailto:bca.permitstocarry@state.mn.us">bca.permitstocarry@state.mn.us</a>	Minnesota Attorney General 102 State Capitol St. Paul, Minnesota 55155 Phone: (651) 296-6196 Fax: (651) 297-4193 <a href="http://www.ag.state.mn.us">http://www.ag.state.mn.us</a>
Minnesota Department of Public Safety 444 Cedar Street Saint Paul, Minnesota 55101 Phone: (651) 282-6565 <a href="mailto:bca.permitstocarry@state.mn.us">bca.permitstocarry@state.mn.us</a>	Minnesota Attorney General 102 State Capitol St. Paul, Minnesota 55155 Phone: (651) 296-6196 Fax: (651) 297-4193 <a href="http://www.ag.state.mn.us">http://www.ag.state.mn.us</a>		
	<a href="http://www.dps.state.mn.us/bca/CJIS/documents/carrypermits/states.html">http://www.dps.state.mn.us/bca/CJIS/documents/carrypermits/states.html</a>		

<b>Mississippi</b>	<b>Right-To-Carry Law Type: Shall Issue</b>		
<b>Issuing Authority:</b>	Department of Public Safety/Highway Patrol		
<b>Contact agency for out of state permits:</b>	Permits not granted.		
<b>These states recognize your permit:</b>	Alabama, Alaska, Florida, Idaho, Indiana, Kentucky, Michigan, Missouri, Montana, Oklahoma, Tennessee, Utah, Vermont, Wyoming		
<b>This state recognizes permits from the following states:</b>	Alabama, Florida, Kentucky, Tennessee, Wyoming		
<b>Cost &amp; Term of Permit:</b>	New: \$100. Renewal: \$50. <span style="float: right;">4 years</span>		
<b>Key Government Offices:</b>	<table style="width: 100%; border: none;"> <tr> <td style="width: 50%; border: none; vertical-align: top;">                     Mississippi State Police                      P. O. Box 958                      Jackson, Mississippi 39205-0958                      Phone: (601) 987-1586                      Email: <a href="mailto:jtucker@dps.state.ms.us">jtucker@dps.state.ms.us</a> </td> <td style="width: 50%; border: none; vertical-align: top;">                     Attorney General                      P.O. Box 220                      Jackson, Mississippi 39205-0220                      Phone: (601) 359-3680  <a href="http://www.ago.state.ms.us">http://www.ago.state.ms.us</a> </td> </tr> </table>	Mississippi State Police P. O. Box 958 Jackson, Mississippi 39205-0958 Phone: (601) 987-1586 Email: <a href="mailto:jtucker@dps.state.ms.us">jtucker@dps.state.ms.us</a>	Attorney General P.O. Box 220 Jackson, Mississippi 39205-0220 Phone: (601) 359-3680 <a href="http://www.ago.state.ms.us">http://www.ago.state.ms.us</a>
Mississippi State Police P. O. Box 958 Jackson, Mississippi 39205-0958 Phone: (601) 987-1586 Email: <a href="mailto:jtucker@dps.state.ms.us">jtucker@dps.state.ms.us</a>	Attorney General P.O. Box 220 Jackson, Mississippi 39205-0220 Phone: (601) 359-3680 <a href="http://www.ago.state.ms.us">http://www.ago.state.ms.us</a>		
	<a href="http://www.dps.state.ms.us/dps/dps.nsf">http://www.dps.state.ms.us/dps/dps.nsf</a>		

## Right-to-Carry Reciprocity and Recognition, cont.

<b>Missouri</b>		Right-To-Carry Law Type: Shall Issue
<b>Issuing Authority:</b>	County Sheriff	
<b>Contact agency for out of state permits:</b>	Permits not granted.	
<b>These states recognize your permit:</b>	Alaska, Arizona, Idaho, Indiana, Kentucky, Michigan, New Hampshire, Oklahoma, Tennessee, Utah, Vermont	
<b>This state recognizes permits from the following states:</b>	All state permits are recognized.	
<b>Cost &amp; Term of Permit:</b>	\$100	3 years
<b>Key Government Offices:</b>	Department of Public Safety P.O. Box 749 Jefferson City, Missouri 65102-0749 Phone: (573) 751-4905 Fax: (573) 751-5399  <a href="http://www.dps.state.mo.us">http://www.dps.state.mo.us</a>	Attorney General Supreme Court Building 207 W. High St. P.O. Box 899 Jefferson City, Missouri 65102 Phone: (573) 751-3321 Fax: (573) 751-0774
<b>Montana</b>		Right-To-Carry Law Type: Shall Issue
<b>Issuing Authority:</b>	County Sheriff	
<b>Contact agency for out of state permits:</b>	Permits not granted.	
<b>These states recognize your permit:</b>	Alaska, Arizona, Colorado, Florida, Idaho, Indiana, Kentucky, Michigan, Missouri, North Carolina, North Dakota, Oklahoma, South Carolina, Tennessee, Utah, Vermont, Wyoming	
<b>This state recognizes permits from the following states:</b>	Alaska, Arizona, Arkansas, California, Colorado, Connecticut, Florida, Georgia, Idaho, Indiana, Iowa, Kentucky, Louisiana, Maryland, Massachusetts, Michigan, Minnesota, Mississippi, Nevada, New Jersey, New Mexico, New York, North Carolina, North Dakota, Oklahoma, Oregon, Pennsylvania, South Carolina, South Dakota, Tennessee, Texas, Utah, Virginia, Washington, West Virginia, Wyoming	
<b>Cost &amp; Term of Permit:</b>	New: \$50. Renewal: \$25.	4 years
<b>Key Government Offices:</b>	Montana Highway Patrol 2550 Prospect Ave. P.O. Box 201419 Helena, Montana 59620-1419 Phone: (406) 444-3780 Fax: (406) 444-4169  <a href="http://www.doj.state.mt.us/enforcement/concealedweapons.asp">http://www.doj.state.mt.us/enforcement/concealedweapons.asp</a>	Montana Attorney General P.O. Box 201401 Helena, Montana 59620-1401 Phone: 406-444-2026 Fax: 406-444-3549 contact:doj@state.mt.us
<b>Nebraska</b>		Right-To-Carry Law Type: Non-Issue
<b>Issuing Authority:</b>	Permits not available	
<b>Contact agency for out of state permits:</b>	Permits not granted.	
<b>These states recognize your permit:</b>	none	
<b>This state recognizes permits from the following states:</b>	none	
<b>Cost &amp; Term of Permit:</b>	n.a	n.a
<b>Key Government Offices:</b>	Nebraska State Patrol P.O. Box 94907 Lincoln, Nebraska 68509 Phone: 402-471-4545  <a href="http://www.nsp.state.ne.us">http://www.nsp.state.ne.us</a>	Attorney General 2115 State Capitol P.O. Box 98920 Lincoln, Nebraska 68509-8920 Phone: 402-471-2682 Fax: 402-471-3297



## Right-to-Carry Reciprocity and Recognition, cont.

<b>Nevada</b>		Right-To-Carry Law Type: Shall Issue
<b>Issuing Authority:</b>	County Sheriff	
<b>Contact agency for out of state permits:</b>	In person with any County Sheriff	
<b>These states recognize your permit:</b>	Alaska, Arizona, Idaho, Indiana, Kentucky, Michigan, Missouri, Montana, Oklahoma, Tennessee, Utah, Vermont	
<b>This state recognizes permits from the following states:</b>	none	
<b>Cost &amp; Term of Permit:</b>	New \$60. Renewal \$25	5 years; 3 years non-resident
<b>Key Government Offices:</b>	Office of the Attorney General 100 N. Carson Street Carson City, Nevada 89701-4717 Phone: (775)684-1100 Fax: (775) 684-1108 Email: aginfo@ag.state.nv.us <a href="http://www.ag.state.nv.us">http://www.ag.state.nv.us</a>	
<b>New Hampshire</b>		Right-To-Carry Law Type: Shall Issue
<b>Issuing Authority:</b>	Selectman/Mayor or Chief of Police	
<b>Contact agency for out of state permits:</b>	Director of State Police	
<b>These states recognize your permit:</b>	Alabama, Alaska, Colorado, Florida, Georgia, Idaho, Indiana, Kentucky, Michigan, Missouri, North Carolina, North Dakota, Oklahoma, Tennessee, Utah, Vermont, Wyoming	
<b>This state recognizes permits from the following states:</b>	Alabama, Alaska, Colorado, Florida, Georgia, Idaho, Indiana, Kentucky, Michigan, North Carolina, North Dakota, Oklahoma, Tennessee, Wyoming	
<b>Cost &amp; Term of Permit:</b>	Residents: \$10. Non Residents: \$20.	4 years
<b>Key Government Offices:</b>	Director of State Police Permits and Licensing Unit 10 Hazen Drive Concord, New Hampshire 03301 Phone: (603) 271-3575 Fax: (603) 271-1153 <a href="http://www.state.nh.us/safety/nhsp/plupr.html">http://www.state.nh.us/safety/nhsp/plupr.html</a>	
<b>New Jersey</b>		Right-To-Carry Law Type: Restrictive May Issue
<b>Issuing Authority:</b>	Chief of Police/Superintendent of State Police	
<b>Contact agency for out of state permits:</b>	Superintendent of State Police--Permits are technically available for non-residents, but are rarely granted.	
<b>These states recognize your permit:</b>	Alaska, Idaho, Indiana, Kentucky, Michigan, Missouri, Montana, Oklahoma, Tennessee, Utah, Vermont	
<b>This state recognizes permits from the following states:</b>	none	
<b>Cost &amp; Term of Permit:</b>	\$20	2 years
<b>Key Government Offices:</b>	New Jersey State Police Firearms Investigation Unit PO Box 7068 West Trenton, NJ 08628-0068 609-882-2000 ext. 2664 Office of the Attorney General Dept. of Law & Public Safety P.O. Box 080 Trenton, New Jersey 08625-0080 Phone: (609) 292-4925, Fax: (609) 292-3508 <a href="http://www.njpublicsafety.com">http://www.njpublicsafety.com</a> <a href="http://www.njsp.org/faq.html#firearms">http://www.njsp.org/faq.html#firearms</a>	

## Right-to-Carry Reciprocity and Recognition, cont.

<b>New Mexico</b>		<b>Right-To-Carry Law Type: Shall Issue</b>
<b>Issuing Authority:</b>	Department of Public Safety	
<b>Contact agency for out of state permits:</b>	Permits not granted.	
<b>These states recognize your permit:</b>	Alaska, Arizona, Colorado, Idaho, Indiana, Kentucky, Michigan, Missouri, Oklahoma, Tennessee, Utah, Vermont	
<b>This state recognizes permits from the following states:</b>	A list of reciprocal states is not available at this time, since New Mexico's new law was implemented 1/1/2004.	
<b>Cost &amp; Term of Permit:</b>	\$100 for initial permit plus fingerprint fee. \$50 for renewal.	2 years
<b>Key Government Offices:</b>	Department of Public Safety P.O. Box 1628 Santa Fe, New Mexico 87504 Phone: (505) 827-3370 or (505) 827-9000  <a href="http://www.dps.nm.org/">http://www.dps.nm.org/</a>	Attorney General 407 Galisteo Street Bataan Memorial Building, Rm 260 Santa Fe, New Mexico 87501 Phone: (505) 827-6000, Fax: (505) 827-5826 <a href="http://www.ago.state.nm.us">http://www.ago.state.nm.us</a>
<b>New York</b>		<b>Right-To-Carry Law Type: Restrictive May Issue</b>
<b>Issuing Authority:</b>	Varies by county	
<b>Contact agency for out of state permits:</b>	Permits not granted.	
<b>These states recognize your permit:</b>	Alaska, Idaho, Indiana, Kentucky, Michigan, Missouri, Montana, Oklahoma, Tennessee, Utah, Vermont	
<b>This state recognizes permits from the following states:</b>	none	
<b>Cost &amp; Term of Permit:</b>	Varies by county	Varies, 2 years to lifetime
<b>Key Government Offices:</b>	State Police Counsel's Office Bldg. 22, 1220 Washington Ave. Albany, New York 12226 Phone: (518) 457-6811  <a href="http://www.troopers.state.ny.us/firearms/firearmsindex.html">http://www.troopers.state.ny.us/firearms/firearmsindex.html</a>	Attorney General 120 Broadway New York, New York 10271-0332 Phone: (212)416-8050 <a href="http://www.oag.state.ny.us">http://www.oag.state.ny.us</a>
<b>North Carolina</b>		<b>Right-To-Carry Law Type: Shall Issue</b>
<b>Issuing Authority:</b>	County Sheriff	
<b>Contact agency for out of state permits:</b>	Permits not granted.	
<b>These states recognize your permit:</b>	Alabama, Alaska, Arizona, Colorado, Delaware, Florida, Georgia, Idaho, Indiana, Kentucky, Michigan, Missouri, Montana, New Hampshire, Oklahoma, Pennsylvania, South Carolina, South Dakota, Tennessee, Utah, Vermont, Virginia	
<b>This state recognizes permits from the following states:</b>	Alabama, Alaska, Arkansas, Arizona, Colorado, Delaware, Florida, Georgia, Idaho, Indiana, Kentucky, Michigan, Montana, New Hampshire, Oklahoma, Pennsylvania, South Carolina, South Dakota, Tennessee, Utah, Virginia, Wyoming	
<b>Cost &amp; Term of Permit:</b>	\$80 permit fee	5 years
<b>Key Government Offices:</b>	North Carolina Highway Partol 512 N. Salisbury Street 4702 Mail Service Center Raleigh, North Carolina 27699-4702 Phone: (919) 733-7952 Email: Webmaster@ncshp.org  <a href="http://www.jus.state.nc.us/">http://www.jus.state.nc.us/</a>	Attorney General North Carolina Department of Justice P.O. Box 629 Raleigh, North Carolina 27602-0629 Phone: 919-716-6400 Fax: 919-716-6750 Email: agjus@mail.jus.state.nc.us



## Right-to-Carry Reciprocity and Recognition, cont.

<b>North Dakota</b>		<b>Right-To-Carry Law Type: Shall Issue</b>
<b>Issuing Authority:</b>	Chief of the Bureau of Criminal Investigation	
<b>Contact agency for out of state permits:</b>	Chief of the Bureau of Criminal Investigation	
<b>These states recognize your permit:</b>	Alabama, Alaska*, Arizona, Delaware, Florida*, Idaho, Indiana, Kentucky, Michigan, Missouri, Montana, New Hampshire, Oklahoma, South Dakota, Tennessee, Utah, Vermont, Wyoming	
<b>This state recognizes permits from the following states:</b>	Alabama, Alaska*, Arizona, Florida*, Indiana, Kentucky, Michigan, Montana, New Hampshire, Oklahoma, South Dakota, Tennessee**, Utah, Wyoming	
<b>Cost &amp; Term of Permit:</b>	\$25	3 years
<b>Key Government Offices:</b>	North Dakota Office of Attorney General Bureau of Criminal Investigation Bismarck, North Dakota 58502-1054 Phone: (701) 328-5500 Fax: (701) 328-5510 Email: <a href="mailto:bciinfo@state.nd.us">bciinfo@state.nd.us</a>	Office of Attorney General State Capitol 600 E Boulevard Ave. Dept 125 Bismarck, North Dakota 58505-0040 Phone: (701) 328-2210 Fax: (701) 328-2226 Email: <a href="mailto:ndag@state.nd.us">ndag@state.nd.us</a>
	<a href="http://www.ag.state.nd.us/BCI/reciprocity.htm">http://www.ag.state.nd.us/BCI/reciprocity.htm</a>	
<b>Ohio</b>		<b>Right-To-Carry Law Type: Shall Issue</b>
<b>Issuing Authority:</b>	County Sheriff	
<b>Contact agency for out of state permits:</b>	Permits not granted.	
<b>These states recognize your permit:</b>	Many states will recognize Ohio permits, once Ohio begins issuing them and the Attorney General has reciprocal agreements in place.	
<b>This state recognizes permits from the following states:</b>	HB 12, which gave Ohio citizens the right to carry a firearm concealed, become law in January, 2004. The Attorney General must now negotiate reciprocal agreements with other states.	
<b>Cost &amp; Term of Permit:</b>	\$45 new and renewal	4 years
<b>Key Government Offices:</b>	Ohio Highway Patrol P O Box 182074 Columbus, Ohio 43232 <a href="http://www.state.oh.us/ohiostatepatrol">http://www.state.oh.us/ohiostatepatrol</a>	Attorney General 30 E. Broad Street 17th Floor Columbus, Ohio 43215-3420 Phone: (614) 466-4320 Fax: (614) 466-5057
	<a href="http://www.ag.state.oh.us/">http://www.ag.state.oh.us/</a>	
<b>Oklahoma</b>		<b>Right-To-Carry Law Type: Shall Issue</b>
<b>Issuing Authority:</b>	State Bureau of Investigation	
<b>Contact agency for out of state permits:</b>	Permits not granted.	
<b>These states recognize your permit:</b>	Alabama, Alaska, Arkansas, Arizona, Colorado, Delaware, Florida, Idaho, Indiana, Kentucky, Michigan, Missouri, Montana, New Hampshire, North Carolina, North Dakota, Tennessee, Texas, Utah, Virginia, Vermont, Wyoming	
<b>This state recognizes permits from the following states:</b>	All state permits recognized.	
<b>Cost &amp; Term of Permit:</b>	New \$100, Renewal \$85.	5 years
<b>Key Government Offices:</b>	Oklahoma State Bureau of Investigation 6600 N. Harvey Suite 300 Oklahoma City, Oklahoma 73116 Phone: (405) 848-6724 or (800)207-6724 outside OK City <a href="mailto:sda@osbi.state.ok.us">sda@osbi.state.ok.us</a>	Attorney General 112 State Capitol 2300 N. Lincoln Blvd. Oklahoma City, Oklahoma 73105 Phone: (405) 521-3921, Fax: (405) 521-6246 <a href="http://www.oag.state.of.us">http://www.oag.state.of.us</a>
	<a href="http://www.osbi.state.ok.us/sda.htm">http://www.osbi.state.ok.us/sda.htm</a>	

## Right-to-Carry Reciprocity and Recognition, cont.

<b>Oregon</b>	<b>Right-To-Carry Law Type: Shall Issue</b>				
<b>Issuing Authority:</b>	County Sheriff				
<b>Contact agency for out of state permits:</b>	Discretionary to residents of contiguous states only				
<b>These states recognize your permit:</b>	Alaska, Arizona, Idaho, Indiana, Kentucky, Michigan, Missouri, Montana, Oklahoma, Tennessee, Utah, Vermont				
<b>This state recognizes permits from the following states:</b>	none				
<b>Cost &amp; Term of Permit:</b>	New: \$65. Renewal \$50. <span style="float: right;">4 years</span>				
<b>Key Government Offices:</b>	<table style="width: 100%; border: none;"> <tr> <td style="width: 50%; border: none; vertical-align: top;">                     State Police                      400 Public Service Bldg.                      255 Capitol St. N.E.                      Salem, Oregon 97310                      Phone: (503) 378-3720 Fax: (503) 378-8282  <a href="http://www.osp.state.or.us">http://www.osp.state.or.us</a> </td> <td style="width: 50%; border: none; vertical-align: top;">                     Attorney General                      Justice Department                      1162 Court St. NE                      Salem Oregon, 97310                      Phone: (503) 378-4400, Fax: (503) 378-5938  <a href="http://www.doj.state.or.us">http://www.doj.state.or.us</a> </td> </tr> <tr> <td colspan="2" style="border: none;"> <a href="http://www.osp.state.or.us">http://www.osp.state.or.us</a> </td> </tr> </table>	State Police 400 Public Service Bldg. 255 Capitol St. N.E. Salem, Oregon 97310 Phone: (503) 378-3720 Fax: (503) 378-8282 <a href="http://www.osp.state.or.us">http://www.osp.state.or.us</a>	Attorney General Justice Department 1162 Court St. NE Salem Oregon, 97310 Phone: (503) 378-4400, Fax: (503) 378-5938 <a href="http://www.doj.state.or.us">http://www.doj.state.or.us</a>	<a href="http://www.osp.state.or.us">http://www.osp.state.or.us</a>	
State Police 400 Public Service Bldg. 255 Capitol St. N.E. Salem, Oregon 97310 Phone: (503) 378-3720 Fax: (503) 378-8282 <a href="http://www.osp.state.or.us">http://www.osp.state.or.us</a>	Attorney General Justice Department 1162 Court St. NE Salem Oregon, 97310 Phone: (503) 378-4400, Fax: (503) 378-5938 <a href="http://www.doj.state.or.us">http://www.doj.state.or.us</a>				
<a href="http://www.osp.state.or.us">http://www.osp.state.or.us</a>					

<b>Pennsylvania</b>	<b>Right-To-Carry Law Type: Shall Issue</b>		
<b>Issuing Authority:</b>	County Sheriff or Chief of Police		
<b>Contact agency for out of state permits:</b>	Any Sheriff's Department		
<b>These states recognize your permit:</b>	Alaska, Florida, Georgia, Idaho, Indiana, Kentucky, Michigan, Missouri, Montana, North Carolina, Oklahoma, Tennessee, Utah, Vermont, Wyoming		
<b>This state recognizes permits from the following states:</b>	Florida, Georgia, Kentucky, Michigan, North Carolina, Wyoming		
<b>Cost &amp; Term of Permit:</b>	\$19 <span style="float: right;">5 years</span>		
<b>Key Government Offices:</b>	<table style="width: 100%; border: none;"> <tr> <td style="width: 50%; border: none; vertical-align: top;">                     State Police                      1800 Elmerton Avenue                      Harrisburg, Pennsylvania 17110-9758                      Phone: (717) 783-5599                      Fax: (717) 787-2948  <a href="http://www.psp.state.pa.us">http://www.psp.state.pa.us</a> </td> <td style="width: 50%; border: none; vertical-align: top;">                     Attorney General                      16th Floor, Strawberry Square                      Harrisburg, Pennsylvania 17120                      Phone: 717-787-3391                      Fax: (717) 787-8242  <a href="http://www.attorneygeneral.gov">http://www.attorneygeneral.gov</a> </td> </tr> </table>	State Police 1800 Elmerton Avenue Harrisburg, Pennsylvania 17110-9758 Phone: (717) 783-5599 Fax: (717) 787-2948 <a href="http://www.psp.state.pa.us">http://www.psp.state.pa.us</a>	Attorney General 16th Floor, Strawberry Square Harrisburg, Pennsylvania 17120 Phone: 717-787-3391 Fax: (717) 787-8242 <a href="http://www.attorneygeneral.gov">http://www.attorneygeneral.gov</a>
State Police 1800 Elmerton Avenue Harrisburg, Pennsylvania 17110-9758 Phone: (717) 783-5599 Fax: (717) 787-2948 <a href="http://www.psp.state.pa.us">http://www.psp.state.pa.us</a>	Attorney General 16th Floor, Strawberry Square Harrisburg, Pennsylvania 17120 Phone: 717-787-3391 Fax: (717) 787-8242 <a href="http://www.attorneygeneral.gov">http://www.attorneygeneral.gov</a>		

<b>Rhode Island</b>	<b>Right-To-Carry Law Type: Restrictive May Issue</b>				
<b>Issuing Authority:</b>	Attorney General				
<b>Contact agency for out of state permits:</b>	Attorney General by mail only. Permits are technically available for non-residents, but are rarely granted.				
<b>These states recognize your permit:</b>	Alaska, Idaho, Indiana, Kentucky, Michigan, Missouri, Oklahoma, Tennessee, Utah, Vermont				
<b>This state recognizes permits from the following states:</b>	none				
<b>Cost &amp; Term of Permit:</b>	\$40 <span style="float: right;">4 years</span>				
<b>Key Government Offices:</b>	<table style="width: 100%; border: none;"> <tr> <td style="width: 50%; border: none; vertical-align: top;">                     State Police                      311 Danielson Pike                      North Scituate, Rhode Island 02857                      Phone: (401) 444-1000                      Fax: (401) 444-1105  <a href="http://www.risp.state.ri.us">http://www.risp.state.ri.us</a> </td> <td style="width: 50%; border: none; vertical-align: top;">                     Attorney General                      150 South Main Street                      Providence, Rhode Island 02903                      Phone: (401) 274-4400                      Fax: (401) 222-1331  <a href="http://www.riag.state.ri.us">http://www.riag.state.ri.us</a> </td> </tr> <tr> <td colspan="2" style="border: none;"> <a href="http://www.riag.state.ri.us/">http://www.riag.state.ri.us/</a> </td> </tr> </table>	State Police 311 Danielson Pike North Scituate, Rhode Island 02857 Phone: (401) 444-1000 Fax: (401) 444-1105 <a href="http://www.risp.state.ri.us">http://www.risp.state.ri.us</a>	Attorney General 150 South Main Street Providence, Rhode Island 02903 Phone: (401) 274-4400 Fax: (401) 222-1331 <a href="http://www.riag.state.ri.us">http://www.riag.state.ri.us</a>	<a href="http://www.riag.state.ri.us/">http://www.riag.state.ri.us/</a>	
State Police 311 Danielson Pike North Scituate, Rhode Island 02857 Phone: (401) 444-1000 Fax: (401) 444-1105 <a href="http://www.risp.state.ri.us">http://www.risp.state.ri.us</a>	Attorney General 150 South Main Street Providence, Rhode Island 02903 Phone: (401) 274-4400 Fax: (401) 222-1331 <a href="http://www.riag.state.ri.us">http://www.riag.state.ri.us</a>				
<a href="http://www.riag.state.ri.us/">http://www.riag.state.ri.us/</a>					



## Right-to-Carry Reciprocity and Recognition, cont.

<b>South Carolina</b>		<b>Right-To-Carry Law Type: Shall Issue</b>
<b>Issuing Authority:</b>	S.C. Law Enforcement Division	
<b>Contact agency for out of state permits:</b>	Permits not granted.	
<b>These states recognize your permit:</b>	Alaska, Arizona, Arkansas, Idaho, Indiana, Kentucky, Michigan, Missouri, Montana, North Carolina, Oklahoma, Tennessee, Utah, Vermont, Virginia, Wyoming	
<b>This state recognizes permits from the following states:</b>	Arkansas, North Carolina, Tennessee, Wyoming	
<b>Cost &amp; Term of Permit:</b>	\$50	4 years
<b>Key Government Offices:</b>	South Carolina Law Enforcement Division Attn: Regulatory Services Unit P.O. Box 21398 Columbia, South Carolina 29221 Phone: 803-896-7014  <a href="http://www.sled.state.sc.us">http://www.sled.state.sc.us</a>	Attorney General Box 11549 Columbia, South Carolina 29211 Phone: (803) 734-3970 Fax: (803) 253-6283 <a href="http://www.scattorneygeneral.org">http://www.scattorneygeneral.org</a>
<b>South Dakota</b>		<b>Right-To-Carry Law Type: Shall Issue</b>
<b>Issuing Authority:</b>	Chief of Police/County Sheriff	
<b>Contact agency for out of state permits:</b>	Permits not granted.	
<b>These states recognize your permit:</b>	Alaska, Colorado, Florida*, Georgia, Idaho, Indiana, Kentucky, Michigan, Missouri, Montana, North Carolina, North Dakota, Oklahoma, Tennessee, Utah, Vermont, Wyoming	
<b>This state recognizes permits from the following states:</b>	Alaska, Colorado*, Florida, Georgia, Indiana, Kentucky, Michigan, Montana, North Carolina, North Dakota, Tennessee, Utah, Wyoming	
<b>Cost &amp; Term of Permit:</b>	\$10	4 years
<b>Key Government Offices:</b>	Highway Patrol 118 West Capitol Pierre, South Dakota 57501 Phone: (605) 773-3105 Fax: (605) 773-6046 <a href="http://hp.state.sd.us/information.htm">http://hp.state.sd.us/information.htm</a>  <a href="http://sdsos.gov/firearms">http://sdsos.gov/firearms</a>	Attorney General 500 East Capitol Ave. Pierre, South Dakota 57501-5070 Phone: (605)-773-3215 Fax: 605)773-4106 <a href="http://www.state.sd.attorney/office/news/concealed.asp">http://www.state.sd.attorney/office/news/concealed.asp</a>
		*must be 21
		*must be 21
<b>Tennessee</b>		<b>Right-To-Carry Law Type: Shall Issue</b>
<b>Issuing Authority:</b>	Department of Public Safety	
<b>Contact agency for out of state permits:</b>	Permits not granted.	
<b>These states recognize your permit:</b>	Alaska, Arizona, Arkansas, Colorado, Delaware, Florida, Georgia, Idaho, Indiana, Kentucky, Louisiana, Michigan, Mississippi, Missouri, Montana, New Hampshire, North Carolina, North Dakota, Oklahoma, South Carolina, South Dakota, Texas, Utah, Virginia, Vermont, Wyoming	
<b>This state recognizes permits from the following states:</b>	All state permits recognized.	
<b>Cost &amp; Term of Permit:</b>	New: \$115; Renewal: \$50	4 years
<b>Key Government Offices:</b>	Tennessee Department of Safety Attn: Handgun Carry Permit Office 1150 Foster Ave Nashville, Tennessee 37249-1000 Phone: (615) 251-8590  <a href="http://www.state.tn.us/safety/">http://www.state.tn.us/safety/</a>	Attorney General P.O. Box 20207 Nashville, Tennessee 37202 Phone: (615) 741-3491 Fax: (615) 741-2009 <a href="http://www.attorneygeneral.state.tn.us">http://www.attorneygeneral.state.tn.us</a>

## Right-to-Carry Reciprocity and Recognition, cont.

<b>Texas</b>		<b>Right-To-Carry Law Type: Shall Issue</b>
<b>Issuing Authority:</b>	Department of Public Safety	
<b>Contact agency for out of state permits:</b>	Department of Public Safety	
<b>These states recognize your permit:</b>	Alaska, Arizona, Arkansas, Florida, Idaho, Indiana, Kentucky, Louisiana, Michigan, Missouri, Montana, Oklahoma, Tennessee, Utah, Virginia, Vermont, Wyoming	
<b>This state recognizes permits from the following states:</b>	Arizona, Arkansas, Florida, Kentucky, Louisiana, Oklahoma, Tennessee, Wyoming	
<b>Cost &amp; Term of Permit:</b>	\$140 (\$70 for seniors)	4 years
<b>Key Government Offices:</b>	Texas Department of Public Safety Concealed Handgun Licensing Section P O Box 4143 Austin, Texas 78791-4143 Phone: (512) 424-7293 or (800) 224-5744 <a href="http://www.txdps.state.tx.us">http://www.txdps.state.tx.us</a>	Attorney General P. O. Box 12548 Austin, Texas 78711-2548 Phone: (512) 463-2100 Fax: (512) 463-2063 <a href="http://www.oag.state.tx.us">http://www.oag.state.tx.us</a>
	<a href="http://www.txdps.state.tx.us/administration/crime_records/chl/reciprocity.htm">http://www.txdps.state.tx.us/administration/crime_records/chl/reciprocity.htm</a>	
<b>Utah</b>		<b>Right-To-Carry Law Type: Shall Issue</b>
<b>Issuing Authority:</b>	Department of Public Safety	
<b>Contact agency for out of state permits:</b>	Department of Public Safety	
<b>These states recognize your permit:</b>	Alabama, Alaska, Arizona, Arkansas, Delaware, Florida, Idaho, Indiana, Kentucky, Michigan, Missouri, Montana, North Carolina, North Dakota, Oklahoma, South Dakota, Vermont, Wyoming	
<b>This state recognizes permits from the following states:</b>	All state permits recognized.	
<b>Cost &amp; Term of Permit:</b>	New \$35, \$10 Renewal	5 years
<b>Key Government Offices:</b>	Utah Department of Public Safety Bureau of Criminal Identification 3888 W. 5400 S. P.O. Box 148280 Salt Lake City, Utah 84114-8280 Phone: (801) 965-4445	Utah Attorney General 236 State Capitol Salt Lake City, Utah 84114 Phone: (801) 366-0260 Fax: (801) 538-1121 <a href="http://www.attorneygeneral.utah.gov">http://www.attorneygeneral.utah.gov</a>
	<a href="http://bci.utah.gov/cfp/cfphone.html">http://bci.utah.gov/cfp/cfphone.html</a>	
<b>Vermont</b>		<b>Right-To-Carry Law Type: Permits Not Required</b>
<b>Issuing Authority:</b>	Permits Not Required	
<b>Contact agency for out of state permits:</b>	Permits Not Required	
<b>These states recognize your permit:</b>	none	
<b>This state recognizes permits from the following states:</b>	Permits Not Required	
<b>Cost &amp; Term of Permit:</b>	n/a	n/a
<b>Key Government Offices:</b>		Attorney General 109 State Street Montpelier, Vermont 05609-1001 Phone: (802) 828 3171 Fax: (802) 828 2154
	<a href="http://www.state.vt.us/atg/">http://www.state.vt.us/atg/</a>	



## Right-to-Carry Reciprocity and Recognition, cont.

<b>Virginia</b>		Right-To-Carry Law Type: Shall Issue
<b>Issuing Authority:</b>	State Circuit Court of residence	
<b>Contact agency for out of state permits:</b>	Permits not granted.	
<b>These states recognize your permit:</b>	Alaska, Idaho, Indiana, Kentucky, Michigan, Missouri, Montana, North Carolina, Oklahoma, Tennessee, Utah, West Virginia, Vermont	
<b>This state recognizes permits from the following states:</b>	Alaska, Arizona, Arkansas, Idaho, Louisiana, Michigan, North Carolina, Oklahoma, South Carolina, Tennessee, Texas, Utah, Washington, West Virginia	
<b>Cost &amp; Term of Permit:</b>	no more than \$50	5 years
<b>Key Government Offices:</b>	Virginia State Police P.O. Box 27472 Richmond, Virginia 23261 Phone: (804) 674-2000  <a href="http://www.vsp.state.va.us/vsp.html">http://www.vsp.state.va.us/vsp.html</a>	Attorney General 900 East Main Street Richmond, Virginia 23219 Phone: (804) 786-2071 Fax: (804) 786-1991 <a href="http://www.oag.state.va.us">http://www.oag.state.va.us</a>
<b>Washington</b>		Right-To-Carry Law Type: Shall Issue
<b>Issuing Authority:</b>	Chief of Police/Sheriff	
<b>Contact agency for out of state permits:</b>	Permits not granted.	
<b>These states recognize your permit:</b>	Alaska, Idaho, Indiana, Kentucky, Michigan, Missouri, Montana, Oklahoma, Tennessee, Utah, Vermont, Virginia	
<b>This state recognizes permits from the following states:</b>	none	
<b>Cost &amp; Term of Permit:</b>	New: \$36; Renewal: \$32	5 years
<b>Key Government Offices:</b>	Washington State Patrol General Administration Building PO Box 42600 Olympia, Washington 98504-2600 Phone: (360) 753-6540 Fax: (360) 753-2492  <a href="http://www.wsp.wa.gov/newsfaqs/answers.htm#weapons">http://www.wsp.wa.gov/newsfaqs/answers.htm#weapons</a>	Attorney General 1125 Washington St. SE Olympia, Washington 98504-0100 Phone: (360) 753-6200 Fax: (360) 664-0988 <a href="http://www.atg.wa.gov">http://www.atg.wa.gov</a>
<b>West Virginia</b>		Right-To-Carry Law Type: Shall Issue
<b>Issuing Authority:</b>	County Sheriff	
<b>Contact agency for out of state permits:</b>	Permits not granted.	
<b>These states recognize your permit:</b>	Alaska, Arizona, Idaho, Indiana, Kentucky, Michigan, Missouri, Montana, Oklahoma, Tennessee, Utah, Vermont, Virginia	
<b>This state recognizes permits from the following states:</b>	Kentucky, Virginia	
<b>Cost &amp; Term of Permit:</b>	\$60	5 years
<b>Key Government Offices:</b>	West Virginia State Police 725 Jefferson Road South Charleston, West Virginia 25309 Phone: (304) 746-2100 Fax: (304) 746-2246  <a href="http://www.wvstatepolice.com/legal/legal.shtml">http://www.wvstatepolice.com/legal/legal.shtml</a>	Attorney General State Capitol, Room 26-E 1900 Kanawha Blvd. East Charleston, West Virginia 25305-0220 Phone: (304) 558-2021 Fax: (304) 558-0140

## Right-to-Carry Reciprocity and Recognition, cont.

<b>Wisconsin</b>	<b>Right-To-Carry Law Type: Non-Issue</b>
<b>Issuing Authority:</b>	Permits not available
<b>Contact agency for out of state permits:</b>	Permits not granted.
<b>These states recognize your permit:</b>	none
<b>This state recognizes permits from the following states:</b>	none
<b>Cost &amp; Term of Permit:</b>	n/a
<b>Key Government Offices:</b>	<div style="border: 1px solid black; padding: 5px;">                     Attorney General                      123 West Washington Ave.                      PO Box 7857                      Madison, Wisconsin 53707-7857                      Phone: 608-266-1221 Fax: 608-267-2779                 </div>
	<a href="http://www.doj.state.wi.us/">http://www.doj.state.wi.us/</a>
<b>Wyoming</b>	<b>Right-To-Carry Law Type: Shall Issue</b>
<b>Issuing Authority:</b>	Attorney General
<b>Contact agency for out of state permits:</b>	Permits not granted.
<b>These states recognize your permit:</b>	Alabama, Alaska, Arizona, Colorado, Florida, Georgia, Idaho, Indiana, Kentucky, Louisiana, Michigan, Minnesota, Mississippi, Missouri, Montana, New Hampshire, North Carolina, North Dakota, Oklahoma, Pennsylvania, South Carolina, South Dakota, Tennessee, Texas, Utah, Vermont
<b>This state recognizes permits from the following states:</b>	Alabama, Alaska, Colorado, Florida, Georgia, Idaho, Indiana, Kentucky, Louisiana, Michigan, Mississippi, Montana, New Hampshire, North Carolina, North Dakota, Oklahoma, Pennsylvania, South Carolina, South Dakota, Tennessee, Texas, Utah
<b>Cost &amp; Term of Permit:</b>	\$74
<b>Key Government Offices:</b>	<div style="border: 1px solid black; padding: 5px;">                     Wyoming Attorney General's Office                      123 Capitol Building                      200 W. 24th Street                      Cheyenne, Wyoming 82002                      Phone: (307) 777-7841                      Fax: (307) 777-6869                 </div>
	<a href="http://attorneygeneral.state.wy.gov/html">http://attorneygeneral.state.wy.gov/html</a>



# PRODUCT & SERVICE DIRECTORY

## **AMMUNITION COMPONENTS, SHOTSHELL**

A.W. Peterson Gun Shop, Inc.  
Ballistic Product, Inc.  
Blount, Inc., Sporting Equipment Div.  
CCI Ammunition ATK  
Cheddite, France S.A.  
Claybuster Wads & Harvester Bullets  
Garcia National Gun Traders, Inc.  
Peterson Gun Shop, Inc., A.W.  
Precision Reloading, Inc.  
Ravell Ltd.  
Tar-Hunt Custom Rifles, Inc.  
Vitt/Boos

## **AMMUNITION COMPONENTS-- BULLETS, POWDER, PRIMERS, CASES**

A.W. Peterson Gun Shop, Inc.  
Acadian Ballistic Specialties  
Accuracy Unlimited  
Accurate Arms Co., Inc.  
Action Bullets & Alloy Inc.  
ADCO Sales, Inc.  
Alaska Bullet Works, Inc.  
Alliant Techsystems Smokeless Powder Group  
Allred Bullet Co.  
Alpha LaFranck Enterprises  
American Products, Inc.  
Arizona Ammunition, Inc.  
Armfield Custom Bullets  
A-Square Co.  
Atlantic Rose, Inc.  
Baer's Hollows  
Ballard Rifle & Cartridge Co., LLC  
Barnes  
Barnes Bullets, Inc.  
Beartooth Bullets  
Bell Reloading, Inc.  
Berger Bullets Ltd.  
Berry's Mfg., Inc.  
Big Bore Bullets of Alaska  
Big Bore Express  
Bitterroot Bullet Co.  
Black Belt Bullets (See Big Bore Express)  
Black Hills Shooters Supply  
Black Powder Products  
Blount, Inc., Sporting Equipment Div.  
Blue Mountain Bullets  
Brenneke GmbH  
Briese Bullet Co., Inc.  
Brown Co., E. Arthur  
Brown Dog Ent.  
BRP, Inc. High Performance Cast Bullets  
Buck Stix-SOS Products Co.  
Buckeye Custom Bullets  
Buckskin Bullet Co.  
Buffalo Arms Co.  
Buffalo Bullet Co., Inc.  
Buffalo Rock Shooters Supply  
Bullseye Bullets  
Bull-X, Inc.  
Butler Enterprises  
Cambos Outdoorsman  
Canyon Cartridge Corp.  
Cascade Bullet Co., Inc.  
Cast Performance Bullet Company  
Casull Arms Corp.  
CCI Ammunition ATK  
Champion's Choice, Inc.  
Cheddite, France S.A.  
CheVron Bullets  
Chuck's Gun Shop

Clean Shot Technologies  
Competitor Corp., Inc.  
Cook Engineering Service  
Corbin Mfg. & Supply, Inc.  
Cummings Bullets  
Curtis Cast Bullets  
Curtis Gun Shop (See Curtis Cast Bullets)  
Custom Bullets by Hoffman  
Dakota Arms, Inc.  
Davide Pedersoli and Co.  
DKT, Inc.  
Dohring Bullets  
Eichelberger Bullets, Wm.  
Federal Cartridge Co.  
Fiocchi of America, Inc.  
Forkin, Ben (See Belt MTN Arms)  
Forkin Arms  
Fowler Bullets  
Fowler, Bob (See Black Powder Products)  
Foy Custom Bullets  
Freedom Arms, Inc.  
Garcia National Gun Traders, Inc.  
Gehmann, Walter (See Huntington Die Specialties)  
GOEX, Inc.  
Golden Bear Bullets  
Gotz Bullets  
Grayback Wildcats  
Green Mountain Rifle Barrel Co., Inc.  
Grier's Hard Cast Bullets  
GTB  
Gun City  
Harris Enterprises  
Harrison Bullets  
Hart & Son, Inc.  
Hawk Laboratories, Inc. (See Hawk, Inc.)  
Hawk, Inc.  
Haydon Shooters Supply, Russ  
Heidenstrom Bullets  
Hercules, Inc. (See Alliant Techsystems, Smokeless)  
Hi-Performance Ammunition Company  
Hirtenberger AG  
Hobson Precision Mfg. Co.  
Hodgdon Powder Co.  
Hornady Mfg. Co.  
HT Bullets  
Hunters Supply, Inc.  
Huntington Die Specialties  
Impact Case & Container, Inc.  
Imperial Magnum Corp.  
IMR Powder Co.  
Intercontinental Distributors, Ltd.  
J&D Components  
J&L Superior Bullets (See Huntington Die Special)  
J.R. Williams Bullet Co.  
James Calhoun Mfg.  
James Calhoun Varmint Bullets  
Jamison International  
Jensen Bullets  
Jensen's Firearms Academy  
Jericho Tool & Die Co., Inc.  
Jester Bullets  
JLK Bullets  
JRP Custom Bullets  
Ka Pu Kapili  
Kaswer Custom, Inc.  
Keith's Bullets  
Keng's Firearms Specialty, Inc./US Tactical Systems  
Ken's Kustom Kartridges  
Kent Cartridge Mfg. Co. Ltd.  
KLA Enterprises  
Knight Rifles  
Knight Rifles (See Modern Muzzle Loading, Inc.)  
Lapua Ltd.

Lawrence Brand Shot (See Precision Reloading)  
Legend Products Corp.  
Liberty Shooting Supplies  
Lightning Performance Innovations, Inc.  
Lindsley Arms Cartridge Co.  
Littleton, J. F.  
Lomont Precision Bullets  
Lyman Products Corp.  
Magnus Bullets  
Maine Custom Bullets  
Maionchi-L.M.I.  
Marchmon Bullets  
Markesbery Muzzle Loaders, Inc.  
MarMik, Inc.  
Marshall Fish Mfg. Gunsmith Sptg. Co.  
MAST Technology, Inc.  
McMurdo, Lynn (See Specialty Gunsmithing)  
Meister Bullets (See Gander Mountain)  
Men-Metallwerk Elisenhuetten GmbH  
Mercuria Ltd.  
Michael's Antiques  
Midway Arms, Inc.  
Mitchell Bullets, R.F.  
MI-TE Bullets  
Montana Precision Swaging  
Mountain State Muzzleloading Supplies, Inc.  
Mulhern, Rick  
Murmur Corp.  
Nagel's Custom Bullets  
National Bullet Co.  
Naval Ordnance Works  
North American Shooting Systems  
North Devon Firearms Services  
Northern Precision Custom Swaged Bullets  
Nosler, Inc.  
OK Weber, Inc.  
Oklahoma Ammunition Co.  
Old Wagon Bullets  
Oregon Trail Bullet Company  
Pacific Cartridge, Inc.  
Pacific Rifle Co.  
Page Custom Bullets  
Pease Accuracy  
Penn Bullets  
Peterson Gun Shop, Inc., A.W.  
Petro-Explo Inc.  
Phillippi Custom Bullets, Justin  
Pinetree Bullets  
PMC/Eldorado Cartridge Corp.  
Polywad, Inc.  
Pony Express Reloaders  
Power Plus Enterprises, Inc.  
Precision Delta Corp.  
Prescott Projectile Co.  
Price Bullets, Patrick W.  
PRL Bullets, c/o Blackburn Enterprises  
Professional Hunter Supplies (See Star Custom Bullets)  
Proofmark Corp.  
R.I.S. Co., Inc.  
Rainier Ballistics Corp.  
Ramon B. Gonzalez Guns  
Ravell Ltd.  
Redwood Bullet Works  
Reloading Specialties, Inc.  
Remington Arms Co., Inc.  
Rhino  
Robinson H.V. Bullets  
Rubright Bullets  
Russ Haydon's Shooters' Supply  
SAECO (See Redding Reloading Equipment)  
Scharch Mfg., Inc.-Top Brass  
Schneider Bullets  
Schroeder Bullets

Schumakers Gun Shop  
Scot Powder  
Seebeck Assoc., R.E.  
Shappy Bullets  
Sharps Arms Co., Inc., C.  
Shilen, Inc.  
Sierra Bullets  
SOS Products Co. (See Buck Stix-SOS Products Co.)  
Southern Ammunition Co., Inc.  
Specialty Gunsmithing  
Speer Bullets  
Spencer's Rifle Barrels, Inc.  
SSK Industries  
Stanley Bullets  
Star Ammunition, Inc.  
Star Custom Bullets  
Starke Bullet Company  
Starline, Inc.  
Stewart's Gunsmithing  
Swift Bullet Co.  
T.F.C. S.p.A.  
Taracor Industries, Inc.  
Tar-Hunt Custom Rifles, Inc.  
TCCI  
TCSR  
The A.W. Peterson Gun Shop, Inc.  
The Gun Works  
The Ordnance Works  
Thompson Bullet Lube Co.  
Thompson Precision  
TMI Products (See Haselbauer Products, Jerry)  
Traditions Performance Firearms  
Trico Plastics  
True Flight Bullet Co.  
Tucson Mold, Inc.  
Unmussig Bullets, D. L.  
USAC  
Vann Custom Bullets  
Vihtavuori Oy/Kaltron-Pettibone  
Vincent's Shop  
Viper Bullet and Brass Works  
Walters Wads  
Warren Muzzleloading Co., Inc.  
Watson Trophy Match Bullets  
Weatherby, Inc.  
Western Nevada West Coast Bullets  
Widener's Reloading & Shooting Supply, Inc.  
Winchester Div. Olin Corp.  
Winkle Bullets  
Woodleigh (See Huntington Die Specialties)  
Worthy Products, Inc.  
Wyant Bullets  
Wyoming Custom Bullets  
Zero Ammunition Co., Inc.

## **AMMUNITION, COMMERCIAL**

3-Ten Corp.  
A.W. Peterson Gun Shop, Inc.  
Ace Custom 45's, Inc.  
Ad Hominem  
Air Arms  
American Ammunition  
Arizona Ammunition, Inc.  
Arms Corporation of the Philippines  
Arundel Arms & Ammunition, Inc., A.  
A-Square Co.  
Atlantic Rose, Inc.  
Badger Shooters Supply, Inc.  
Ballistic Product, Inc.  
Ben William's Gun Shop  
Benjamin/Sheridan Co., Crosman  
Big Bear Arms & Sporting Goods, Inc.  
Black Hills Ammunition, Inc.

Blammo Ammo  
Blount, Inc., Sporting Equipment Div.  
Brenneke GmbH  
Buffalo Bullet Co., Inc.  
Bull-X, Inc.  
Cabela's  
Cambos Outdoorsman  
Casull Arms Corp.  
CBC  
Champion's Choice, Inc.  
Cor-Bon Inc./Glaser LLC  
Crosman Airguns  
Cubic Shot Shell Co., Inc.  
Daisy Outdoor Products  
Dead Eye's Sport Center  
Delta Arms Ltd.  
Delta Frangible Ammunition LLC  
Dynamit Nobel-RWS, Inc.  
Effebe SNC-Dr. Franco Beretta  
Eley Ltd.  
Elite Ammunition  
Estate Cartridge, Inc.  
Federal Cartridge Co.  
Fiocchi of America, Inc.  
Garcia National Gun Traders, Inc.  
Garrett Cartridges, Inc.  
Garthwaite Pistolsmith, Inc., Jim  
Gibbs Rifle Co., Inc.  
Gil Hebard Guns Inc.  
Glaser LLC  
Glaser Safety Slug, Inc.  
GOEX, Inc.  
Goodwin's Gun Shop  
Gun City  
Hansen & Co.  
Hart & Son, Inc.  
Hi-Performance Ammunition Company  
Hirtenberger AG  
Hornady Mfg. Co.  
Hunters Supply, Inc.  
Intercontinental Distributors, Ltd.  
Ion Industries, Inc.  
Keng's Firearms Specialty, Inc./US Tactical Systems  
Kent Cartridge America, Inc.  
Kent Cartridge Mfg. Co. Ltd.  
Knight Rifles  
Lapua Ltd.  
Lethal Force Institute (See Police Bookshelf)  
Lock's Philadelphia Gun Exchange  
Magnum Research, Inc.  
MagSafe Ammo Co.  
Magtech Ammunition Co. Inc.  
Maionchi-L.M.I.  
Mandall Shooting Supplies Inc.  
Markell, Inc.  
Marshall Fish Mfg. Gunsmith Sptg. Co.  
McBros Rifle Co.  
Men-Metallwerk Elisenhuetten GmbH  
Mullins Ammunition  
New England Ammunition Co.  
Oklahoma Ammunition Co.  
Omark Industries, Div. of Blount, Inc.  
Outdoor Sports Headquarters, Inc.  
P.S.M.G. Gun Co.  
Pacific Cartridge, Inc.  
Paragon Sales & Services, Inc.  
Parker & Sons Shooting Supply  
Parker Gun Finishes  
Peterson Gun Shop, Inc., A.W.  
PMC/Eldorado Cartridge Corp.  
Police Bookshelf  
Polywad, Inc.  
Pony Express Reloaders  
Precision Delta Corp.  
Pro Load Ammunition, Inc.  
R.E.I.  
Ravell Ltd.

# PRODUCT & SERVICE DIRECTORY

Remington Arms Co., Inc.  
Rucker Dist. Inc.  
RWS (See US Importer-Dynamit Nobel-RWS, Inc.)  
Sellier & Bellot, USA Inc.  
Southern Ammunition Co., Inc.  
Speer Bullets  
TCCI  
The A.W. Peterson Gun Shop, Inc.  
The BulletMakers Workshop  
The Gun Room Press  
The Gun Works  
Thompson Bullet Lube Co.  
USAC  
VAM Distribution Co. LLC  
Victory USA  
Vihtavuori Oy/Kaltron-Pettibone Visible Impact Targets  
Voere-KGH GmbH  
Weatherby, Inc.  
Westley Richards & Co.  
Whitestone Lumber Corp.  
Widener's Reloading & Shooting Supply, Inc.  
William E. Phillips Firearms  
Winchester Div. Olin Corp.  
Zero Ammunition Co., Inc.

## AMMUNITION, CUSTOM

3-Ten Corp.  
A.W. Peterson Gun Shop, Inc.  
Accuracy Unlimited  
AFSCO Ammunition  
Allred Bullet Co.  
American Derringer Corp.  
American Products, Inc.  
Arizona Ammunition, Inc.  
Arms Corporation of the Philippines  
Atlantic Rose, Inc.  
Ballard Rifle & Cartridge Co., LLC  
Bear Arms  
Belding's Custom Gun Shop  
Berger Bullets Ltd.  
Big Bore Bullets of Alaska  
Black Hills Ammunition, Inc.  
Blue Mountain Bullets  
Brynin, Milton  
Buckskin Bullet Co.  
CBC  
CFVentures  
Champlin Firearms, Inc.  
Cubic Shot Shell Co., Inc.  
Custom Tackle and Ammo  
Dakota Arms, Inc.  
Dead Eye's Sport Center  
Delta Frangible Ammunition LLC  
DKT, Inc.  
Elite Ammunition  
Estate Cartridge, Inc.  
GDL Enterprises  
GOEX, Inc.  
Grayback Wildcats  
Hirtenberger AG  
Hobson Precision Mfg. Co.  
Horizons Unlimited  
Hornady Mfg. Co.  
Hunters Supply, Inc.  
James Calhoun Mfg.  
James Calhoun Varmint Bullets  
Jensen Bullets  
Jensen's Custom Ammunition  
Jensen's Firearms Academy  
Kaswer Custom, Inc.  
Kent Cartridge Mfg. Co. Ltd.  
L. E. Jurras & Assoc.  
L.A.R. Mfg., Inc.  
Lethal Force Institute (See Police Bookshelf)  
Lindsley Arms Cartridge Co.  
Linebaugh Custom Sixguns  
Loch Leven Industries/Convert-A-Pell

MagSafe Ammo Co.  
MAST Technology, Inc.  
McBros Rifle Co.  
McMurdo, Lynn (See Specialty Gunsmithing)  
Men-Metallwerk Eisenhuette GmbH  
Milstor Corp.  
Mullins Ammunition  
Oklahoma Ammunition Co.  
P.S.M.G. Gun Co.  
Peterson Gun Shop, Inc., A.W.  
Phillippi Custom Bullets, Justin  
Police Bookshelf  
Power Plus Enterprises, Inc.  
Precision Delta Corp.  
Professional Hunter Supplies (See Star Custom Bullets)  
R.E.I.  
Ramon B. Gonzalez Guns  
Sandia Die & Cartridge Co.  
SOS Products Co. (See Buck Stix-SOS Products Co.)  
Specialty Gunsmithing  
Spencer's Rifle Barrels, Inc.  
SSK Industries  
Star Custom Bullets  
Stewart's Gunsmithing  
The A.W. Peterson Gun Shop, Inc.  
The BulletMakers Workshop  
The Country Armourer  
Unmussig Bullets, D. L.  
Vitt/Boos  
Vulpes Ventures, Inc. Fox Cartridge Division  
Warren Muzzleloading Co., Inc.  
Watson Trophy Match Bullets  
Worthy Products, Inc.  
Zero Ammunition Co., Inc.

## AMMUNITION, FOREIGN

A.W. Peterson Gun Shop, Inc.  
Ad Hominem  
AFSCO Ammunition  
Armscorp USA, Inc.  
Atlantic Rose, Inc.  
B&P America  
Beeman Precision Airguns  
Cape Outfitters  
CBC  
Cheddite, France S.A.  
Cubic Shot Shell Co., Inc.  
Dead Eye's Sport Center  
DKT, Inc.  
Dynamit Nobel-RWS, Inc.  
E. Arthur Brown Co.  
Fiocchi of America, Inc.  
First Inc., Jack  
Gamebore Division, Polywad Inc.  
Gibbs Rifle Co., Inc.  
GOEX, Inc.  
Goodwin's Gun Shop  
Gunsmithing, Inc.  
Hansen & Co.  
Heidenstrom Bullets  
Hirtenberger AG  
Hornady Mfg. Co.  
I.S.S.  
Intrac Arms International  
K.B.I. Inc.  
MagSafe Ammo Co.  
Maionchi-L.M.I.  
Mandall Shooting Supplies Inc.  
Marksman Products  
MAST Technology, Inc.  
Mercuria Ltd.  
Mullins Ammunition  
Navy Arms Company  
Oklahoma Ammunition Co.  
P.S.M.G. Gun Co.  
Paragon Sales & Services, Inc.  
Peterson Gun Shop, Inc., A.W.  
Petro-Explo Inc.

Precision Delta Corp.  
R.E.T. Enterprises  
Ramon B. Gonzalez Guns  
RWS (See US Importer-Dynamit Nobel-RWS, Inc.)  
Samco Global Arms, Inc.  
Sentinel Arms  
Southern Ammunition Co., Inc.  
Speer Bullets  
Stratco, Inc.  
T.F.C. S.p.A.  
The A.W. Peterson Gun Shop, Inc.  
The BulletMakers Workshop  
The Paul Co.  
Victory Ammunition  
Vihtavuori Oy/Kaltron-Pettibone  
Vulpes Ventures, Inc. Fox Cartridge Division  
Wolf Performance Ammunition

## BOOKS & MANUALS (PUBLISHERS & DEALERS)

"Su-Press-On", Inc.  
Alpha 1 Drop Zone  
American Handgunner Magazine  
Armory Publications  
Arms & Armour Press  
Ballistic Product, Inc.  
Ballistic Product, Inc.  
Barnes Bullets, Inc.  
Bauska Barrels  
Beartooth Bullets  
Beeman Precision Airguns  
Blacksmith Corp.  
Blacktail Mountain Books  
Blue Book Publications, Inc.  
Blue Ridge Machinery & Tools, Inc.  
Boone's Custom Ivory Grips, Inc.  
Brown Co., E. Arthur  
Brownells, Inc.  
Bullet N Press  
C. Sharps Arms Co. Inc./Montana Armory  
Cape Outfitters  
Cheyenne Pioneer Products  
Colonial Repair  
Corbin Mfg. & Supply, Inc.  
DBI Books Division of Krause Publications  
deHaas Barrels  
Dixon Muzzleloading Shop, Inc.  
Excalibur Publications  
Executive Protection Institute  
Galati International  
Gerald Pettinger Books (See Pettinger Books)  
Golden Age Arms Co.  
Gun City  
Gun List (See Krause Publications)  
Guncraft Books (See Guncraft Sports Inc.)  
Guncraft Sports Inc.  
Gunnerman Books  
GUNS Magazine  
Gunsmithing, Inc.  
H&P Publishing  
Handgun Press  
Harris Publications  
Hawk Laboratories, Inc. (See Hawk, Inc.)  
Hawk, Inc.  
Heritage/VSP Gun Books  
Hodgdon Powder Co.  
Home Shop Machinist, The Village Press Publications  
Hornady Mfg. Co.  
Huntington Die Specialties  
I.D.S.A. Books  
Info-Arm  
Ironsides International Publishers, Inc.

Jantz Supply  
Kelley's  
King & Co.  
Koval Knives  
Krause Publications, Inc.  
L.B.T.  
Lapua Ltd.  
Lebeau-Courally  
Lethal Force Institute (See Police Bookshelf)  
Lyman Products Corp.  
Madis Books  
Magma Engineering Co.  
Mandall Shooting Supplies Inc.  
MarMik, Inc.  
Montana Armory, Inc. (See C. Sharps Arms Co. Inc.)  
Mountain South  
Mountain State Muzzleloading Supplies, Inc.  
Mulberry House Publishing  
Navy Arms Company  
Numrich Gun Parts Corporation  
OK Weber, Inc.  
Outdoor Sports Headquarters, Inc.  
Paintball Games International Magazine Aceville  
Pejsa Ballistics  
Peterson Publishing Co.  
Pettinger Books, Gerald  
PFRB Co.  
Police Bookshelf  
Precision Shooting, Inc.  
Professional Hunter Supplies (See Star Custom Bullets)  
Ravell Ltd.  
Ray Riling Arms Books Co.  
Remington Double Shotguns  
Russ Haydon's Shooters' Supply  
Rutgers Book Center  
S&S Firearms  
Safari Press, Inc.  
Saunders Gun & Machine Shop  
Sarch Mfg., Inc.-Top Brass  
Sarch Mfg., Inc.-Top Brass  
Semmer, Charles (See Remington Double Shotguns)  
Sharps Arms Co., Inc., C.  
Shotgun Sports Magazine, dba "Shootin' Accessories Ltd.  
Sierra Bullets  
Speer Bullets  
SPG LLC  
Stackpole Books  
Star Custom Bullets  
Stewart Game Calls, Inc., Johnny  
Stoeger Industries  
Stoeger Publishing Co. (See Stoeger Industries)  
Swift Bullet Co.  
The A.W. Peterson Gun Shop, Inc.  
The Gun Room Press  
The Gun Works  
The NgraveR Co.  
Thomas, Charles C.  
Track of the Wolf, Inc.  
Trafalgar Square  
Trotman, Ken  
Tru-Balance Knife Co.  
Vega Tool Co.  
Vintage Industries, Inc.  
VSP Publishers (See Heritage/VSP Gun Books)  
W.E. Brownell Checkering Tools  
WAMCO-New Mexico  
Wells Creek Knife & Gun Works  
Wilderness Sound Products Ltd.  
Williams Gun Sight Co.  
Wolfe Publishing Co.  
Wolf's Western Traders

## CASES, CABINETS, RACKS & SAFES - GUN

All Rite Products, Inc.  
Allen Co., Bob  
Allen Co., Inc.  
Allen Sportswear, Bob (See Allen Co., Bob)  
Alumna Sport by Dee Zee  
American Display Co.  
American Security Products Co.  
Americase  
Art Jewel Enterprises Ltd.  
Ashby Turkey Calls  
Bagmaster Mfg., Inc.  
Barramundi Corp.  
Berry's Mfg., Inc.  
Big Spring Enterprises "Bore Stores"  
Bill's Custom Cases  
Bison Studios  
Black Sheep Brand  
Brauer Bros.  
Brown, H. R. (See Silhouette Leathers)  
Browning Arms Co.  
Bushmaster Hunting & Fishing Cannon Safe, Inc.  
Chipmunk (See Oregon Arms, Inc.)  
Cobalt Mfg., Inc.  
CONKKO  
Connecticut Shotgun Mfg. Co.  
D&L Industries (See D.J. Marketing)  
D.J. Marketing  
Dara-Nes, Inc. (See Nesco Enterprises, Inc.)  
Deepeeka Exports Pvt. Ltd.  
Dorskocil Mfg. Co., Inc.  
DTM International, Inc.  
EMF Co., Inc.  
English, Inc., A.G.  
Enhanced Presentations, Inc.  
Eversull Co., Inc.  
Fort Knox Security Products  
Freedom Arms, Inc.  
Frontier Safe Co.  
Galati International  
GALCO International Ltd.  
Gun-Ho Sports Cases  
Hall Plastics, Inc., John  
Hastings  
Homak  
Hoppe's Div. Penguin Industries, Inc.  
Hunter Co., Inc.  
Hydrosorbent Products  
Impact Case & Container, Inc.  
Johanssons Vapentillbehov, Bert  
Johnston Bros. (See C&T Corp. TA Johnson Brothers)  
Kalispel Case Line  
Kane Products, Inc.  
KK Air International (See Impact Case & Container Co.)  
Knock on Wood Antiques  
Kolpin Mfg., Inc.  
Lakewood Products LLC  
Liberty Safe  
Mandall Shooting Supplies Inc.  
Marsh, Mike  
McWelco Products  
Morton Booth Co.  
MPC  
MTM Molded Products Co., Inc.  
Nalpak  
Necessary Concepts, Inc.  
Nesco Enterprises Inc.  
Oregon Arms, Inc. (See Rogue Rifle Co., Inc.)  
Outa-Site Gun Carriers  
Pflumm Mfg. Co.  
Poburka, Philip (See Bison Studios)



# PRODUCT & SERVICE DIRECTORY

Powell & Son (Gunmakers) Ltd.,  
William  
Protektor Model  
Prototech Industries, Inc.  
Rogue Rifle Co., Inc.  
Schulz Industries  
Southern Security  
Sportsman's Communicators  
Sun Welding Safe Co.  
Sweet Home, Inc.  
Talmage, William G.  
The Outdoor Connection, Inc.  
The Surecase Co.  
Tinks & Ben Lee Hunting Products  
(See Wellington)  
Trulock Tool  
Universal Sports  
W. Waller & Son, Inc.  
Whitestone Lumber Corp.  
Wilson Case, Inc.  
Woodstream  
Zanotti Armor, Inc.  
Ziegel Engineering

## CLEANING & REFINISHING SUPPLIES

AC Dyna-tite Corp.  
Alpha 1 Drop Zone  
American Gas & Chemical Co., Ltd  
Answer Products Co.  
Armitage Laboratories  
Atlantic Mills, Inc.  
Atsko/Sno-Seal, Inc.  
Barnes Bullets, Inc.  
Battenfeld Technologies  
Beeman Precision Airguns  
Belltown Ltd.  
Bill's Gun Repair  
Birchwood Casey  
Blount, Inc., Sporting Equipment  
Div.  
Blount/Outers ATK  
Blue and Gray Products Inc. (See  
Ox-Yoke Originals)  
Break-Free, Inc.  
Bridgers Best  
Brown Co., E. Arthur  
Brownells, Inc.  
C.S. Van Gorden & Son, Inc.  
Cambos Outdoorsman  
Cambos Outdoorsman  
Camp-Cap Products  
CONKKO  
Connecticut Shotgun Mfg. Co.  
Creedmoor Sports, Inc.  
CRR, Inc./Marble's Inc.  
Custom Products (See Jones  
Custom Products)  
Cylinder & Slide, Inc., William R.  
Laughridge  
Dara-Nes, Inc. (See Nesci  
Enterprises, Inc.)  
Deepeeka Exports Pvt. Ltd.  
Desert Mountain Mfg.  
Du-Lite Corp.  
Dykstra, Doug  
E&L Mfg., Inc.  
Eezox, Inc.  
Ekol Leather Care  
Faith Associates  
Flitz International Ltd.  
Fluoramics, Inc.  
Frontier Products Co.  
G96 Products Co., Inc.  
Golden Age Arms Co.  
Guardman Products  
Gunsmithing, Inc.  
Hafner World Wide, Inc.  
Half Moon Rifle Shop  
Heatbath Corp.  
Hoppe's Div. Penguin Industries,  
Inc.

Hornady Mfg. Co.  
Hydrosorbent Products  
Iosso Products  
J. Dewey Mfg. Co., Inc.  
Jantz Mfg.  
Jantz Supply  
Johnston Bros. (See G&T Corp. TA  
Johnson Brothers)  
Jonad Corp.  
K&M Industries, Inc.  
Kellogg's Professional Products  
Kent Cartridge Mfg. Co. Ltd.  
Kesselring Gun Shop  
Kleen-Bore, Inc.  
Knight Rifles  
Laurel Mountain Forge  
Lee Supplies, Mark  
LEM Gun Specialties, Inc. The  
Lewis Lead Remover  
List Precision Engineering  
LPS Laboratories, Inc.  
Lyman Products Corp.  
Mac-1 Airgun Distributors  
Mandall Shooting Supplies Inc.  
Marble Arms (See CRR,  
Inc./Marble's Inc.)  
Mark Lee Supplies  
Micro Sight Co.  
Minute Man High Tech Industries  
Mountain State Muzzleloading  
Supplies, Inc.  
MTM Molded Products Co., Inc.  
Muscle Products Corp.  
Nesci Enterprises Inc.  
Northern Precision Custom  
Swaged Bullets  
Now Products, Inc.  
October Country Muzzleloading  
Old World Oil Products  
Omark Industries, Div. of Blount,  
Inc.  
Original Mink Oil, Inc.  
Otis Technology, Inc.  
Outers Laboratories Div. of ATK  
Ox-Yoke Originals, Inc.  
Parker & Sons Shooting Supply  
Parker Gun Finishes  
Pendleton Royal, c/o Swingler  
Buckland Ltd.  
Perazone-Gunsmith, Brian  
Pete Rickard, Inc.  
Peter Dyson & Son Ltd.  
Precision Airgun Sales, Inc.  
PrOlix Lubricants  
Pro-Shot Products, Inc.  
R&S Industries Corp.  
Radiator Specialty Co.  
Rooster Laboratories  
Russ Haydon's Shooters' Supply  
Rustepufe Laboratories  
Rusty Duck Premium Gun Care  
Products  
Saunders Gun & Machine Shop  
Schumakers Gun Shop  
Sheffield Knifemakers Supply, Inc.  
Shooter's Choice Gun Care  
Shotgun Sports Magazine, dba  
Shootin' Accessories Ltd.  
Silencio/Safety Direct  
Sinclair International, Inc.  
Sno-Seal, Inc. (See Atsko/Sno-  
Seal, Inc.)  
Southern Bloomer Mfg. Co.  
Splitfire Sporting Goods, L.L.C.  
Starr Trading Co., Jedediah  
Stoney Point Products, Inc.  
Svon Corp.  
T.F.C. S.p.A.  
TDP Industries, Inc.  
Tetra Gun Care  
Texas Platers Supply Co.  
The A.W. Peterson Gun Shop, Inc.  
The Dutchman's Firearms, Inc.

The Lewis Lead Remover (See LEM  
Gun Specialties)  
The Paul Co.  
Track of the Wolf, Inc.  
United States Products Co.  
Van Gorden & Son Inc., C. S.  
Venco Industries, Inc. (See  
Shooter's Choice Gun Care)  
VibraShine, Inc.  
Volquartsen Custom Ltd.  
Warren Muzzleloading Co., Inc.  
Watson Trophy Match Bullets  
WD-40 Co.  
Wick, David E.  
Willow Bend  
Wolf's Western Traders  
Young Country Arms

## CUSTOM GUNSMITH

A&W Repair  
A.A. Arms, Inc.  
Acadian Ballistic Specialties  
Accuracy Unlimited  
Ace Custom 45's, Inc.  
Acra-Bond Laminates  
Adair Custom Shop, Bill  
Ahlman Guns  
Al Lind Custom Guns  
Aldis Gunsmithing & Shooting  
Supply  
Alpha Precision, Inc.  
Alpine Indoor Shooting Range  
Amrine's Gun Shop  
Answer Products Co.  
Antique Arms Co.  
Armament Gunsmithing Co., Inc.  
Arms Craft Gunsmithing  
Arms Ingenuity Co.  
Armscorp USA, Inc.  
Artistry in Wood  
Art's Gun & Sport Shop, Inc.  
Arundel Arms & Ammunition, Inc.,  
A.  
Autauga Arms, Inc.  
Badger Creek Studio  
Baelder, Harry  
Baer Custom Inc., Les  
Bain & Davis, Inc.  
Bansner's Ultimate Rifles, LLC  
Barnes Bullets, Inc.  
Baron Technology  
Barta's Gunsmithing  
Bear Arms  
Bear Mountain Gun & Tool  
Beaver Lodge (See Fellowes, Ted)  
Behlert Precision, Inc.  
Beitzinger, George  
Belding's Custom Gun Shop  
Ben William's Gun Shop  
Bengtson Arms Co., L.  
Bill Adair Custom Shop  
Billings Gunsmiths  
BlackStar AccuMax Barrels  
BlackStar Barrel Accurizing (See  
BlackStar AccuMax)  
Bob Rogers Gunsmithing  
Bond Custom Firearms  
Borden Ridges Rimrock Stocks  
Borovnik KG, Ludwig  
Bowen Classic Arms Corp.  
Brace, Larry D.  
Briese Bullet Co., Inc.  
Briganti, A.J.  
Briley Mfg. Inc.  
Broad Creek Rifle Works, Ltd.  
Brockman's Custom Gunsmithing  
Broken Gun Ranch  
Brown Precision, Inc.  
Brown Products, Inc., Ed  
Buchsenmachermeister  
Buckhorn Gun Works  
Budim, Dave  
Bull Mountain Rifle Co.

Bullberry Barrel Works, Ltd.  
Burkhart Gunsmithing, Don  
Cache La Poudre Rifleworks  
Cambos Outdoorsman  
Cambos Outdoorsman  
Campbell, Dick  
Carolina Precision Rifles  
Carter's Gun Shop  
Caywood, Shane J.  
CBC-BRAZIL  
Chambers Flintlocks Ltd., Jim  
Champlin Firearms, Inc.  
Chicasaw Gun Works  
Chuck's Gun Shop  
Chuilli, Stephen  
Clark Custom Guns, Inc.  
Clark Firearms Engraving  
Classic Arms Company  
Classic Arms Corp.  
Clearview Products  
Cleveland's Outdoor World, Inc  
Coffin, Charles H.  
Cogar's Gunsmithing  
Cole's Gun Works  
Colonial Arms, Inc.  
Colonial Repair  
Colorado Gunsmithing Academy  
Colorado School of Trades  
Colt's Mfg. Co., Inc.  
Conrad, C. A.  
Corkys Gun Clinic  
Cox, Ed. C.  
Cullity Restoration  
Custom Gun Stocks  
Custom Single Shot Rifles  
D&D Gunsmiths, Ltd.  
Dangler, Homer L.  
D'Arcy Echols & Co.  
Darlington Gun Works, Inc.  
Dave's Gun Shop  
David Miller Co.  
David R. Chicoine  
David W. Schwartz Custom Guns  
Davis, Don  
Delorge, Ed  
Del-Sports, Inc.  
DGR Custom Rifles  
DGS, Inc., Dale A. Storey  
Dietz Gun Shop & Range, Inc.  
Dillioitt Gunsmithing, Inc.  
Donnelly, C. P.  
Duane A. Hobbie Gunsmithing  
Duane's Gun Repair (See DGR  
Custom Rifles)  
Duffy, Charles E (See Guns Antique  
& Modern DBA)  
Duncan's Gun Works, Inc.  
E. Arthur Brown Co.  
Eckelman Gunsmithing  
Ed Brown Products, Inc.  
Eggleston, Jere D.  
Entre'prise Arms, Inc.  
Erhardt, Dennis  
Eversull Co., Inc.  
Evolution Gun Works Inc.  
F.I., Inc. - High Standard Mfg. Co.  
FERLIB  
Ferris Firearms  
Fisher, Jerry A.  
Fisher Custom Firearms  
Fleming Firearms  
Flynn's Custom Guns  
Forkin, Ben (See Belt MTN Arms)  
Forkin Arms  
Forster, Kathy (See Custom  
Checkering)  
Forster, Larry L.  
Forthofer's Gunsmithing &  
Knifemaking  
Francesca, Inc.  
Francotte & Cie S.A. Auguste  
Fred F. Wells/Wells Sport Store  
Frontier Arms Co., Inc.  
Fullmer, Geo. M.

G.G. & G.  
Galaxy Imports Ltd., Inc.  
Garthwaite Pistolsmith, Inc., Jim  
Gary Reeder Custom Guns  
Gator Guns & Repair  
Genecco Gun Works  
Gene's Custom Guns  
Gentry Custom Gunmaker, David  
George E. Mathews & Son, Inc.  
George Hoenig, Inc.  
Gillmann, Edwin  
Gilman-Mayfield, Inc.  
Gilmore Sports Concepts  
Giron, Robert E.  
Goens, Dale W.  
Gonic Arms/North American Arm  
Goodling's Gunsmithing  
Goodwin's Gun Shop  
Grace, Charles E.  
Grayback Wildcats  
Graybill's Gun Shop  
Green, Roger M.  
Greg Gunsmithing Repair  
Gre-Tan Rifles  
Griffin & Howe, Inc.  
Griffin & Howe, Inc.  
Griffin & Howe, Inc.  
Gruning Precision Inc.  
Guncraft Books (See Guncraft  
Sports Inc.)  
Guncraft Sports Inc.  
Guncraft Sports, Inc.  
Guns Antique & Modern DBA /  
Charles E. Duffy  
Gunsite Custom Shop  
Gunsite Gunsmithy (See Gunsite  
Custom Shop)  
Gunsite Training Center  
Gunsmithing Ltd.  
Hamilton, Alex B (See Ten-Ring  
Precision, Inc)  
Hammans, Charles E.  
Hammerli Service-Precision Mac  
Hammond Custom Guns Ltd.  
Hank's Gun Shop  
Hanson's Gun Center, Dick  
Harris Gunworks  
Harry Lawson Co.  
Hart & Son, Inc.  
Hart Rifle Barrels, Inc.  
Hartmann & Weiss GmbH  
Harwood, Jack O.  
Hawken Shop, The (See Dayton  
Traister)  
Hecht, Hubert J. Waffnen-Hecht  
Heilmann, Stephen  
Heinie Specialty Products  
Hensley, Gunmaker, Darwin  
High Bridge Arms, Inc  
High Performance International  
High Precision  
Highline Machine Co.  
Hill, Loring F.  
Hiptmayer, Armurier  
Hiptmayer, Klaus  
Hoag, James W.  
Hodgson, Richard  
Hoehn Sales, Inc.  
Hofer Jagdwaffen, P.  
Holland's Gunsmithing  
Huebner, Corey O.  
Hunkeler, A (See Buckskin Machine  
Works)  
Imperial Magnum Corp.  
Irwin, Campbell H.  
Island Pond Gun Shop  
Israel Arms International, Inc.  
Ivanoff, Thomas G. (See Tom's  
Gun Repair)  
J&S Heat Treat  
J.J. Roberts / Engraver  
Jack Dever Co.  
Jackalope Gun Shop  
James Calhoun Mfg.

# PRODUCT & SERVICE DIRECTORY

James Calhoun Varmint Bullets  
Jamison's Forge Works  
Jarrett Rifles, Inc.  
Jarvis, Inc.  
Jay McCament Custom Gunmaker  
Jeffredo Gunsight  
Jensen's Custom Ammunition  
Jim Norman Custom Gunstocks  
Jim's Gun Shop (See Spradlin's)  
Jim's Precision, Jim Ketchum  
John Norrell Arms  
John Rigby & Co.  
Jones Custom Products, Neil A. Juenke, Vern  
K. Eversull Co., Inc.  
KDF, Inc.  
Keith's Custom Gunstocks  
Ken Eyster Heritage Gunsmiths, Inc.  
Ken Starnes Gunmaker  
Ketchum, Jim (See Jim's Precision)  
Kilham & Co.  
King's Gun Works  
KLA Enterprises  
Klein Custom Guns, Don Kleinendorst, K. W.  
KOGOT  
Korzinek Riflesmith, J. L. E. Jurras & Assoc.  
LaFrance Specialties  
Lampert, Ron  
LaRocca Gun Works  
Larry Lyons Gunworks  
Lathrop's, Inc.  
Laughridge, William R (See Cylinder & Slide Inc)  
Lawson Co., Harry  
Lazzeroni Arms Co.  
LeFever Arms Co., Inc.  
Linebaugh Custom Sixguns  
List Precision Engineering  
Lock's Philadelphia Gun Exchange  
Lone Star Rifle Company  
Long, George F.  
Mag-Na-Port International, Inc.  
Mahony, Philip Bruce  
Mahony, Philip Bruce  
Mahovsky's Metalife  
Makinson, Nicholas  
Mandall Shooting Supplies Inc.  
Marshall Fish Mfg. Gunsmith Sptg. Co.  
Martin's Gun Shop  
Martz, John V.  
Mathews & Son, Inc., George E.  
Mazur Restoration, Pete  
McCann's Muzzle-Gun Works  
McCluskey Precision Rifles  
McGowen Rifle Barrels  
McMillan Rifle Barrels  
MCS, Inc.  
Mercer Custom Guns  
Michael's Antiques  
Mid-America Recreation, Inc.  
Middlebrooks Custom Shop  
Miller Arms, Inc.  
Miller Custom  
Mills Jr., Hugh B.  
Moeller, Steve  
Monell Custom Guns  
Montgomery Community College  
Morrison Custom Rifles, J. W.  
Morrow, Bud  
Mo's Competitor Supplies (See MCS, Inc.)  
Mowrey's Guns & Gunsmithing  
Mullis Guncraft  
Muzzleloaders Etcetera, Inc.  
NCP Products, Inc.  
Neil A. Jones Custom Products  
Nelson's Custom Guns, Inc.  
Nettestad Gun Works  
New England Arms Co.

New England Custom Gun Service  
Newman Gunshop  
Nicholson Custom  
Nickels, Paul R.  
Nicklas, Ted  
Nitex Gun Shop  
North American Shooting Systems  
Nu-Line Guns, Inc.  
Old World Gunsmithing  
Olson, Vic  
Ottmar, Maurice  
Ox-Yoke Originals, Inc.  
Ozark Gun Works  
P&M Sales & Services, LLC  
P.S.M.G. Gun Co.  
PAC-NOR Barreling  
Pagel Gun Works, Inc.  
Parker & Sons Shooting Supply  
Parker Gun Finishes  
Pasadena Gun Center  
Paterson Gunsmithing  
Paulsen Gunstocks  
Peacemaker Specialists  
PEM's Mfg. Co.  
Pence Precision Barrels  
Pennsylvania Gunsmith School  
Penrod Precision  
Pentheny de Pentheny  
Performance Specialists  
Pete Mazur Restoration  
Peter Dyson & Son Ltd.  
Peterson Gun Shop, Inc., A.W.  
Piquette's Custom Engraving  
Plum City Ballistic Range  
Powell & Son (Gunmakers) Ltd., William  
Power Custom, Inc.  
Professional Hunter Supplies (See Star Custom Bullets)  
Quality Custom Firearms  
R&J Gun Shop  
R.A. Wells Custom Gunsmith  
Ramon B. Gonzalez Guns  
Ray's Gunsmith Shop  
Renfrew Guns & Supplies  
Ridgetop Sporting Goods  
Ries, Chuck  
RMS Custom Gunsmithing  
Robert Valade Engraving  
Robinson, Don  
Rocky Mountain Arms, Inc.  
Romain's Custom Guns, Inc.  
Ron Frank Custom Classic Arms  
Ruger's Custom Guns  
Rupert's Gun Shop  
Savage Arms, Inc.  
Schiffman, Mike  
Schumakers Gun Shop  
Score High Gunsmithing  
Sharp Shooter Supply  
Shaw, Inc., E. R. (See Small Arms Mfg. Co.)  
Shay's Gunsmithing  
Shockley, Harold H.  
Shooters Supply  
Shootin' Shack  
Shooting Specialties (See Titus, Daniel)  
Shotguns Unlimited  
Silver Ridge Gun Shop (See Goodwin, Fred)  
Simmons Gun Repair, Inc.  
Singletary, Kent  
Siskiyou Gun Works (See Donnelly, C. P.)  
Skeoch, Brian R.  
Sklany's Machine Shop  
Slezak, Jerome F.  
Small Arms Mfg. Co.  
Small Arms Specialists  
Smith, Art  
Snapp's Gunshop  
Sound Technology  
Speiser, Fred D.

Spencer Reblue Service  
Spencer's Rifle Barrels, Inc.  
Splitfire Sporting Goods, L.L.C.  
Sportsmen's Exchange & Western Gun Traders, Inc.  
Springfield Armory  
Springfield, Inc.  
SSK Industries  
Star Custom Bullets  
Steelman's Gun Shop  
Steffens, Ron  
Steven Dodd Hughes  
Stiles Custom Guns  
Stott's Creek Armory, Inc.  
Sturgeon Valley Sporters  
Sullivan, David S. (See Westwind Rifles Inc.)  
Swann, D. J.  
Swenson's 45 Shop, A. D.  
Swift River Gunworks  
Szveda, Robert (See RMS Custom Gunsmithing)  
Taconic Firearms Ltd., Perry Lane  
Talmage, William G.  
Tank's Rifle Shop  
Tar-Hunt Custom Rifles, Inc.  
Tarnhelm Supply Co., Inc.  
Taylor & Robbins  
Ten-Ring Precision, Inc.  
Terry K. Kopp Professional Gunsmithing  
The A.W. Peterson Gun Shop, Inc.  
The Competitive Pistol Shop  
The Custom Shop  
The Gun Shop  
The Gun Works  
The Orvis Co.  
The Robar Co.'s, Inc.  
The Swampfire Shop (See Peterson Gun Shop, Inc.)  
Theis, Terry  
Thompson, Randall (See Highline Machine Co.)  
Thurston Sports, Inc.  
Time Precision  
Tom's Gun Repair, Thomas G. Ivanoff  
Tom's Gunshop  
Trevallion Gunstocks  
Trulock Tool  
Tucker, James C.  
Turnbull Restoration, Doug  
Unmussig Bullets, D. L.  
Upper Missouri Trading Co.  
Van Horn, Gil  
Van Patten, J. W.  
Van's Gunsmith Service  
Vest, John  
Vic's Gun Refinishing  
Vintage Arms, Inc.  
Virgin Valley Custom Guns  
Volquartsen Custom Ltd.  
Walker Arms Co., Inc.  
Wallace, Terry  
Wasmundt, Jim  
Wayne E. Schwartz Custom Guns  
Weatherby, Inc.  
Weber & Markin Custom Gunsmiths  
Weems, Cecil  
Werth, T. W.  
Wessinger Custom Guns & Engraving  
Western Design (See Alpha Gunsmith Division)  
Westley Richards & Co.  
Westwind Rifles, Inc., David S. Sullivan  
White Barn Wor  
White Rifles, Inc.  
Wichita Arms, Inc.  
Wiebe, Duane  
Wild West Guns  
William E. Phillips Firearms

Williams Gun Sight Co.  
Williams Shootin' Iron Service, The Lynx-Line  
Williamson Precision Gunsmithing  
Wilsom Combat  
Winter, Robert M.  
Wise Guns, Dale  
Wiseman and Co., Bill  
Wood, Frank (See Classic Guns, Inc.)  
Working Guns  
Wright's Gunstock Blanks  
Yankee Gunsmith "Just Glocks"  
Zeeryp, Russ

## GUN PARTS, U.S. & FOREIGN

"Su-Press-On", Inc.  
A.A. Arms, Inc.  
Ahlman Guns  
Amherst Arms  
Antique Arms Co.  
Armscorp USA, Inc.  
Auto-Ordance Corp.  
B.A.C.  
Badger Shooters Supply, Inc.  
Ballard Rifle & Cartridge Co., LLC  
Bar-Sto Precision Machine  
Bear Mountain Gun & Tool  
Billings Gunsmiths  
Bill's Gun Repair  
Bob's Gun Shop  
Briese Bullet Co., Inc.  
Brown Products, Inc., Ed  
Brownells, Inc.  
Bryan & Assoc.  
Buffer Technologies  
Cambos Outdoorsman  
Cambos Outdoorsman  
Cape Outfitters  
Caspian Arms, Ltd.  
CBC-BRAZIL  
Chicasaw Gun Works  
Ciener Inc., Jonathan Arthur  
Cole's Gun Works  
Colonial Arms, Inc.  
Colonial Repair  
Colt's Mfg. Co., Inc.  
Custom Riflestocks, Inc., Michael M. Kokolus  
Cylinder & Slide, Inc., William R. Laughridge  
David R. Chicoine  
Delta Arms Ltd.  
DGR Custom Rifles  
Dibble, Derek A.  
Dixie Gun Works  
Duane's Gun Repair (See DGR Custom Rifles)  
Duffy, Charles E (See Guns Antique & Modern DBA)  
E.A.A. Corp.  
Elliott Inc., G. W.  
EMF Co., Inc.  
Enquix Import-Export  
Entreprise Arms, Inc.  
European American Armory Corp (See E.A.A. Corp)  
Evolution Gun Works Inc.  
F.I., Inc. - High Standard Mfg. Co.  
Faloon Industries, Inc.  
Federal Arms Corp. of America  
Fleming Firearms  
Forrest Inc., Tom  
Century Custom Gunmaker, David  
Glimm's Custom Gun Engraving  
Goodwin's Gun Shop  
Granite Mountain Arms, Inc.  
Greider Precision  
Gre-Tan Rifles  
Groenewold, John

Gun Hunter Books (See Gun Hunter Trading Co.)  
Gun Hunter Trading Co.  
Guns Antique & Modern DBA / Charles E. Duffy  
Gunsmithing, Inc.  
Hastings  
Hawken Shop, The (See Dayton Traister)  
High Performance International I.S.S.  
Irwin, Campbell H.  
Jack Bull, Inc.  
Jamison's Forge Works  
Jonathan Arthur Ciener, Inc.  
Kimber of America, Inc.  
Knight's Mfg. Co.  
Krico Deutschland GmbH  
LaFrance Specialties  
Lampert, Ron  
LaPrade  
Laughridge, William R (See Cylinder & Slide Inc)  
Leapers, Inc.  
List Precision Engineering  
Lodewick, Walter H.  
Logdewood Mfg.  
Long, George F.  
Mandall Shooting Supplies Inc.  
Markell, Inc.  
Martin's Gun Shop  
McCormick Corp., Chip  
MCS, Inc.  
Merkuria Ltd.  
Mid-America Recreation, Inc.  
Morrow, Bud  
Mo's Competitor Supplies (See MCS, Inc.)  
North Star West  
Northwest Arms  
Nu-Line Guns, Inc.  
Numrich Gun Parts Corporation  
Nygord Precision Products, Inc.  
Olathe Gun Shop  
Olympic Arms Inc.  
P.S.M.G. Gun Co.  
Pacific Armament Corp  
Pennsylvania Gun Parts Inc  
Performance Specialists  
Peter Dyson & Son Ltd.  
Peterson Gun Shop, Inc., A.W.  
Ranch Products  
Randco UK  
Ravell Ltd.  
Retting, Inc., Martin B  
Romain's Custom Guns, Inc.  
Ruger (See Sturm, Ruger & Co., Inc.)  
Rutgers Book Center  
S&S Firearms  
Sabatti SPA  
Samco Global Arms, Inc.  
Sarco, Inc.  
Shockley, Harold H.  
Shootin' Shack  
Silver Ridge Gun Shop (See Goodwin, Fred)  
Simmons Gun Repair, Inc.  
Smires, C. L.  
Smith & Wesson  
Southern Ammunition Co., Inc.  
Sportsmen's Exchange & Western Gun Traders, Inc.  
Springfield Sporters, Inc.  
Springfield, Inc.  
Steyr Mannlicher GmbH P Co KG  
STI International  
Strayer-Voigt, Inc.  
Sturm Ruger & Co. Inc.  
Sunny Hill Enterprises, Inc.  
T&S Industries, Inc.  
Tank's Rifle Shop  
Tarnhelm Supply Co., Inc.



# PRODUCT & SERVICE DIRECTORY

Terry K. Kopp Professional  
Gunsmithing  
The A.W. Peterson Gun Shop, Inc.  
The Gun Room Press  
The Gun Shop  
The Gun Works  
The Southern Armory  
The Swampfire Shop (See Peterson  
Gun Shop, Inc.)  
VAM Distribution Co. LLC  
Vektor USA  
Vintage Arms, Inc.  
W. Waller & Son, Inc.  
W.C. Wolff Co.  
Walker Arms Co., Inc.  
Wescombe, Bill (See North Star  
West)  
Whitestone Lumber Corp.  
Wild West Guns  
Williams Mfg. of Oregon  
Winchester Suttler, Inc., The  
Wise Guns, Dale  
Wisners Inc/Twin Pine Armory

## **GUNS, FOREIGN MANUFACTURER U.S. IMPORTER**

Accuracy International Precision  
Rifles (See U.S.)  
Accuracy Int'l. North America, Inc.  
Ad Hominem  
Air Arms  
Armas Garbi, S.A.  
Armas Kernen S. A. (See U.S.  
Importers)  
Armi Perazzi S.p.A.  
Armi San Marco (See U.S.  
Importers-Taylor's & Co I  
Armi Sport (See U.S. Importers-  
Cape Outfitters)  
Arms Corporation of the  
Philippines  
Armscorp USA, Inc.  
Arrieta S.L.  
Astra Sport, S.A.  
Atamec-Bretton  
AYA (See U.S. Importer-New  
England Custom Gun Serv  
B.A.C.  
B.C. Outdoors  
BEC, Inc.  
Benelli Armi S.p.A.  
Benelli USA Corp  
Beretta S.p.A., Pietro  
Beretta U.S.A. Corp.  
Bernardelli S.p.A., Vincenzo  
Bersa S.A.  
Bertuzzi (See U.S. Importer-New  
England Arms Co)  
Bill Hanus Birdguns  
Blaser Jagdwaffen GmbH  
Borovnik KG, Ludwig  
Bosis (See U.S. Importer-New  
England Arms Co.)  
Brenneke GmbH  
Browning Arms Co.  
Bryan & Assoc.  
BSA Guns Ltd.  
Cabanas (See U.S. Importer-  
Mandall Shooting Supply  
Cabela's  
Cape Outfitters  
CBC  
Chapuis Armes  
Churchill (See U.S. Importer-Ellett  
Bros.)  
Conetrol Scope Mounts  
Cosmi Americo & Figlio s.n.c.  
Crucellegui, Hermanos (See U.S.  
Importer-Mandall)  
Cubic Shot Shell Co., Inc.  
Daewoo Precision Industries Ltd.

Dakota (See U.S. Importer-EMF  
Co., Inc.)  
Dakota Arms, Inc.  
Daly, Charles (See U.S. Importer)  
Davide Pedersoli and Co.  
Domino  
Dumoulin, Ernest  
Eagle Imports, Inc.  
EAW (See U.S. Importer-New  
England Custom Gun Serv  
Ed's Gun House  
Effebe SNC-Dr. Franco Beretta  
EMF Co., Inc.  
Eversull Co., Inc.  
F.A.I.R.  
Fabarm S.p.A.  
FEG  
Feinwerkbau Westinger &  
Altenburger  
Felk Pistols Inc.  
FERLIB  
Fiocchi Munizioni S.p.A. (See U.S.  
Importer-Fiocch  
Firearms Co Ltd. / Alpine (See U.S.  
Importer-Mandall  
Firearms International  
Flintlocks, Etc.  
Franchi S.p.A.  
Galaxy Imports Ltd., Inc.  
Gamba S.p.A. Societa Armi  
Bresciane Srl  
Gamo (See U.S. Importers-Arms  
United Corp, Daisy M  
Gaucher Armes, S.A.  
Gibbs Rifle Co., Inc.  
Glock GmbH  
Goergen's Gun Shop, Inc.  
Griffin & Howe, Inc.  
Griffin & Howe, Inc.  
Grulla Armes  
Hammerli Ltd.  
Hammerli USA  
Hartford (See U.S. Importer-EMF  
Co. Inc.)  
Hartmann & Weiss GmbH  
Heckler & Koch, Inc.  
Hege Jagd-u. Sporthandels GmbH  
Helwan (See U.S. Importer-  
Interarms)  
Holland & Holland Ltd.  
Howa Machinery, Ltd.  
I.A.B. (See U.S. Importer-Taylor's  
& Co. Inc.)  
IAR Inc.  
IGA (See U.S. Importer-Stoeger  
Industries)  
Ignacio Ugartechea S.A.  
Imperial Magnum Corp.  
Imperial Miniature Armory  
Import Sports Inc.  
Inter Ordnance of America LP  
Intrac Arms International  
J.G. Anschutz GmbH & Co. KG  
JSL Ltd (See U.S. Importer-  
Specialty Shooters)  
K. Eversull Co., Inc.  
Kimar (See U.S. Importer-IAR, Inc)  
Korth Germany GmbH  
Krico Deutschland GmbH  
Kriehoff Gun Co., H.  
Lakefield Arms Ltd. (See Savage  
Arms, Inc.)  
Lapua Ltd.  
Laurona Armas Eibar, S.A.L.  
Lebeau-Courally  
Lever Arms Service Ltd.  
Llama Gabilondo Y Cia  
London Guns Ltd.  
M. Thys (See U.S. Importer-  
Champlin Firearms Inc)  
Magtech Ammunition Co. Inc.  
Mandall Shooting Supplies Inc.  
Marocchi F.lli S.p.A

Mauser Werke Oberndorf  
Waffensysteme GmbH  
McCann Industries  
MEC-Gar S.R.L.  
Merkel  
Miltex, Inc  
Morini (See U.S. Importers-  
Mandall Shooting Supply)  
New England Custom Gun Service  
New SKB Arms Co.  
Norica, Avnda Otaola  
Norinco  
Norma Precision AB (See U.S.  
Importers-Dynamit)  
Northwest Arms  
Nygord Precision Products, Inc.  
OK Weber, Inc.  
Para-Ordnance Mfg., Inc.  
Pardini Armi Srl  
Perugini Visini & Co. S.r.l.  
Peters Stahl GmbH  
Pietta (See U.S. Importers-Navy  
Arms Co, Taylor's  
Piotti (See U.S. Importer-Moore &  
Co. Wm. Larkin)  
PMC/Eldorado Cartridge Corp.  
Powell & Son (Gunmakers) Ltd.,  
William  
Prairie Gun Works  
Ramon B. Gonzalez Guns  
Rizzini F.lli (See U.S. Importers-  
Moore & C England)  
Rizzini SNC  
Robinson Armament Co.  
Rossi Firearms  
Rottweil Compe  
Rutten (See U.S. Importer-Labanu  
Inc)  
RWS (See US Importer-Dynamit  
Nobel-RWS, Inc.)  
S.A.R.L. G. Granger  
S.I.A.C.E. (See U.S. Importer-IAR  
Inc)  
Sabatti SPA  
Sako Ltd (See U.S. Importer-  
Stoeger Industries)  
San Marco (See U.S. Importers-  
Cape Outfitters-EMF  
Sarsilmaz Shotguns - Turkey (see  
B.C. Outdoors)  
Sauer (See U.S. Importers-Paul  
Co., The, Sigarms I  
Savage Arms (Canada), Inc.  
SIG  
Sigarms, Inc.  
SIG-Sauer (See U.S. Importer-  
Sigarms Inc.)  
SKB Shotguns  
Small Arms Specialists  
Societa Armi Bresciane Srl (See  
U.S. Importer-Cape  
Sphinx Systems Ltd.  
Springfield Armory  
Springfield, Inc.  
Starr Trading Co., Jedediah  
Steyr Mannlicher GmbH P Co KG  
T.F.C. S.p.A.  
Tanfoglio Fratelli S.r.l.  
Tanner (See U.S. Importer-Mandall  
Shooting Supply)  
Tar-Hunt Custom Rifles, Inc.  
Taurus International Firearms (See  
U.S. Importer)  
Taurus S.A. Forjas  
Taylor's & Co., Inc.  
Techno Arms (See U.S. Importer-  
Auto-Ordnance Corp  
The A.W. Peterson Gun Shop, Inc.  
Tikka (See U.S. Importer-Stoeger  
Industries)  
TOZ (See U.S. Importer-Nygord  
Precision Products)  
Ugartechea S. A., Ignacio

Ultralux (See U.S. Importer-Keng's  
Firearms)  
Unique/M.A.P.F.  
Valtro USA, Inc  
Verney-Carron  
Voere-KGH GmbH  
Walther GmbH, Carl  
Weatherby, Inc.  
Webley and Scott Ltd.  
Weihrauch KG, Hermann  
Westley Richards & Co.  
Whiscombe (See U.S. Importer-  
Pelairé Products)  
Wolf (See J.R. Distributing)  
Yankee Gunsmith "Just Glocks"  
Zabala Hermanos S.A.

## **GUNS, FOREIGN- IMPORTER**

Accuracy International  
AcuSport Corporation  
Air Rifle Specialists  
American Frontier Firearms Mfg.,  
Inc  
Auto-Ordnance Corp.  
B.A.C.  
B.C. Outdoors  
Bell's Legendary Country Wear  
Benelli USA Corp  
Big Bear Arms & Sporting Goods,  
Inc.  
Bill Hanus Birdguns  
Bridgeman Products  
British Sporting Arms  
Browning Arms Co.  
Cape Outfitters  
Century International Arms, Inc.  
Champion Shooters' Supply  
Champion's Choice, Inc.  
Chapuis USA  
Cimarron F.A. Co.  
CVA  
CZ USA  
Dixie Gun Works  
Dynamit Nobel-RWS, Inc.  
E&L Mfg., Inc.  
E.A.A. Corp.  
Eagle Imports, Inc.  
Ellett Bros.  
EMF Co., Inc.  
Euroarms of America, Inc.  
Eversull Co., Inc.  
Fiocchi of America, Inc.  
Flintlocks, Etc.  
Franzen International, Inc (See U.S.  
Importer for)  
G.U. Inc (See U.S. Importer for  
New SKB Arms Co.)  
Galaxy Imports Ltd., Inc.  
Gamba, USA  
Gamo USA, Inc.  
Giacomo Sporting USA  
Glock, Inc.  
Gremmel Enterprises  
GSI, Inc.  
Guncraft Books (See Guncraft  
Sports Inc.)  
Guncraft Sports Inc.  
Gunsite Custom Shop  
Gunsite Training Center  
Hammerli USA  
I.S.S.  
IAR Inc.  
Imperial Magnum Corp.  
Imperial Miniature Armory  
Import Sports Inc.  
Intrac Arms International  
K. Eversull Co., Inc.  
K.B.I. Inc.  
Kemen America  
Keng's Firearms Specialty, Inc./US  
Tactical Systems

Kriehoff International, Inc.  
Labanu, Inc.  
Legacy Sports International  
Lion Country Supply  
London Guns Ltd.  
Magnum Research, Inc.  
Marx, Harry (See U.S. Importer for  
FERLIB)  
MCS, Inc.  
MEC-Gar U.S.A., Inc.  
Navy Arms Company  
New England Arms Co.  
Nygord Precision Products, Inc.  
OK Weber, Inc.  
P.S.M.G. Gun Co.  
Para-Ordnance, Inc.  
Parker Reproductions  
Pelairé Products  
Perazzi U.S.A. Inc.  
Powell Agency, William  
Precision Sales International, Inc.  
Rocky Mountain Armoury  
S.D. Meacham  
Safari Arms/Schuetzen Pistol  
Works  
Samco Global Arms, Inc.  
Savage Arms, Inc.  
Scott Fine Guns Inc., Thad  
Sigarms, Inc.  
SKB Shotguns  
Small Arms Specialists  
Southern Ammunition Co., Inc.  
Specialty Shooters Supply, Inc.  
Springfield, Inc.  
Stoeger Industries  
Stone Enterprises Ltd.  
Swarovski Optik North America  
Ltd.  
Tar-Hunt Custom Rifles, Inc.  
Taurus Firearms, Inc.  
Taylor's & Co., Inc.  
The A.W. Peterson Gun Shop, Inc.  
The Gun Shop  
The Orvis Co.  
The Paul Co.  
Track of the Wolf, Inc.  
Traditions Performance Firearms  
Tristar Sporting Arms, Ltd.  
Trooper Walsh  
U.S. Importer-Wm. Larkin Moore  
VAM Distribution Co. LLC  
Vektor USA  
Vintage Arms, Inc.  
VTI Gun Parts  
Westley Richards Agency USA (See  
U.S. Importer for  
Wingshooting Adventures

## **GUNS, SURPLUS, PARTS & AMMUNITION**

Ahlman Guns  
Alpha 1 Drop Zone  
Armscorp USA, Inc.  
Arundel Arms & Ammunition, Inc.,  
A.  
B.A.C.  
Bondini Paolo  
Cambos Outdoorsman  
Century International Arms, Inc.  
Cole's Gun Works  
Conetrol Scope Mounts  
Delta Arms Ltd.  
Ed's Gun House  
First Inc., Jack  
Fleming Firearms  
Forrest Inc., Tom  
Garcia National Gun Traders, Inc.  
Goodwin's Gun Shop  
Gun City  
Gun Hunter Books (See Gun Hunter  
Trading Co.)  
Gun Hunter Trading Co.

# PRODUCT & SERVICE DIRECTORY

Hank's Gun Shop  
Hege Jagd-u. Sporthandels GmbH  
Jackalope Gun Shop  
Ken Starnes Gunmaker  
LaRocca Gun Works  
Lever Arms Service Ltd.  
Log Cabin Sport Shop  
Martin's Gun Shop  
Navy Arms Company  
Nevada Pistol Academy, Inc.  
Northwest Arms  
Numrich Gun Parts Corporation  
Oil Rod and Gun Shop  
Olathe Gun Shop  
Paragon Sales & Services, Inc.  
Pasadena Gun Center  
Power Plus Enterprises, Inc.  
Ravell Ltd.  
Retting, Inc., Martin B  
Rutgers Book Center  
Samco Global Arms, Inc.  
Sarco, Inc.  
Shootin' Shack  
Silver Ridge Gun Shop (See Goodwin, Fred)  
Simmons Gun Repair, Inc.  
Sportsmen's Exchange & Western Gun Traders, Inc.  
Springfield Sporters, Inc.  
T.F.C. S.p.A.  
Tarnhelm Supply Co., Inc.  
The A.W. Peterson Gun Shop, Inc.  
The Gun Room Press  
Thurston Sports, Inc.  
Williams Shootin' Iron Service, The Lynx-Line

## GUNS, U.S. MADE

3-Ten Corp.  
A.A. Arms, Inc.  
Accu-Tek  
Ace Custom 45's, Inc.  
Acra-Bond Laminates  
Ad Hominem  
Airrow  
Allred Bullet Co.  
American Derringer Corp.  
American Frontier Firearms Mfg., Inc.  
AR-7 Industries, LLC  
ArmaLite, Inc.  
Armcorp USA, Inc.  
A-Square Co.  
Austin & Halleck, Inc.  
Autauga Arms, Inc.  
Auto-Ordnance Corp.  
Baer Custom Inc., Les  
Ballard Rifle & Cartridge Co., LLC  
Barrett Firearms Manufacturer, Inc.  
Bar-Sto Precision Machine  
Benjamin/Sheridan Co., Crosman  
Beretta S.p.A., Pietro  
Beretta U.S.A. Corp.  
Big Bear Arms & Sporting Goods, Inc.  
Bill Russ Trading Post  
Bond Arms, Inc.  
Borden Ridges Rimrock Stocks  
Borden Rifles Inc.  
Brockman's Custom Gunsmithing  
Brown Co., E. Arthur  
Brown Products, Inc., Ed  
Browning Arms Co.  
Bryan & Assoc.  
Bushmaster Firearms  
C. Sharps Arms Co. Inc./Montana Armory  
Cabela's  
Calico Light Weapon Systems  
Cambos Outdoorsman  
Cape Outfitters  
Casull Arms Corp.  
CCL Security Products

Century Gun Dist. Inc.  
Champlin Firearms, Inc.  
Charter 2000  
Cobra Enterprises, Inc.  
Colt's Mfg. Co., Inc.  
Competitor Corp., Inc.  
Conetrol Scope Mounts  
Connecticut Shotgun Mfg. Co.  
Connecticut Valley Classics (See CVC, BPI)  
Cooper Arms  
Crosman Airguns  
Cumberland Arms  
Cumberland Mountain Arms  
CVA  
Daisy Outdoor Products  
Dakota Arms, Inc.  
Dan Wesson Firearms  
Dayton Traister  
Dixie Gun Works  
Downsizer Corp.  
DS Arms, Inc.  
DunLyon R&D Inc.  
E&L Mfg., Inc.  
E. Arthur Brown Co.  
Eagle Arms, Inc. (See ArmaLite, Inc.)  
Ed Brown Products, Inc.  
Emerging Technologies, Inc. (See Laseraim Technologies, Inc.)  
Entre'prise Arms, Inc.  
Essex Arms  
Excel Industries Inc.  
F.I., Inc. - High Standard Mfg. Co.  
Fletcher-Bidwell, LLC.  
FN Manufacturing  
Fort Worth Firearms  
Freedom Arms, Inc.  
Fulton Armory  
Galena Industries AMT  
Garcia National Gun Traders, Inc.  
Gary Reeder Custom Guns  
Genecco Gun Works  
Gentry Custom Gunmaker, David  
George Hoenig, Inc.  
George Madis Winchester Consultants  
Gibbs Rifle Co., Inc.  
Gil Hebard Guns Inc.  
Gilbert Equipment Co., Inc.  
Goergen's Gun Shop, Inc.  
Goodwin's Gun Shop  
Granite Mountain Arms, Inc.  
Grayback Wildcats  
Gunsite Custom Shop  
Gunsite Gunsmithy (See Gunsite Custom Shop)  
H&R 1871.LLC  
Hammans, Charles E.  
Hammerli USA  
Harrington & Richardson (See H&R 1871, Inc.)  
Harris Gunworks  
Hart & Son, Inc.  
Hatfield Gun  
Hawken Shop, The (See Dayton Traister)  
Heritage Firearms (See Heritage Mfg., Inc.)  
Heritage Manufacturing, Inc.  
Hesco-Meprolight  
High Precision  
Hi-Point Firearms/MKS Supply  
HJS Arms, Inc.  
H-S Precision, Inc.  
Hutton Rifle Ranch  
IAR Inc.  
Imperial Miniature Armory  
Israel Arms International, Inc.  
Ithaca Classic Doubles  
Ithaca Gun Company LLC  
J.P. Enterprises Inc.  
Jim Norman Custom Gunstocks  
John Rigby & Co.

John's Custom Leather  
K.B.I. Inc.  
Kahr Arms  
Kehr, Roger  
Kelbly, Inc.  
Kel-Tec CNC Industries, Inc.  
Kimber of America, Inc.  
Knight Rifles  
Knight's Mfg. Co.  
Kolar  
L.A.R. Mfg., Inc.  
L.W. Seecamp Co., Inc.  
LaFrance Specialties  
Lakefield Arms Ltd. (See Savage Arms, Inc.)  
Laseraim Technologies, Inc.  
Lever Arms Service Ltd.  
Ljutic Industries, Inc.  
Lock's Philadelphia Gun Exchange  
Lomont Precision Bullets  
Lone Star Rifle Company  
Mag-Na-Port International, Inc.  
Magnum Research, Inc.  
Mandall Shooting Supplies Inc.  
Marlin Firearms Co.  
Maverick Arms, Inc.  
McBros Rifle Co.  
McCann Industries  
Mid-America Recreation, Inc.  
Miller Arms, Inc.  
MKS Supply, Inc. (See Hi-Point Firearms)  
MOA Corporation  
Montana Armory, Inc. (See C. Sharps Arms Co. Inc.)  
MPI Stocks  
Navy Arms Company  
NCP Products, Inc.  
New Ultra Light Arms, LLC  
Noreen, Peter H.  
North American Arms, Inc.  
North Star West  
Northwest Arms  
Nowlin Mfg. Co.  
Olympic Arms Inc.  
Oregon Arms, Inc. (See Rogue Rifle Co., Inc.)  
P&M Sales & Services, LLC  
Parker & Sons Shooting Supply  
Parker Gun Finishes  
Phillips & Rogers, Inc.  
Phoenix Arms  
Precision Small Arms Inc.  
ProWare, Inc.  
Ramon B. Gonzalez Guns  
Rapine Bullet Mould Mfg. Co.  
Remington Arms Co., Inc.  
Robinson Armament Co.  
Rock River Arms  
Rocky Mountain Arms, Inc.  
Rogue Rifle Co., Inc.  
Rogue River Rifleworks  
Rohrbaugh  
Romain's Custom Guns, Inc.  
RPM  
Ruger (See Sturm, Ruger & Co., Inc.)  
Safari Arms/Schuetzen Pistol Works  
Savage Arms (Canada), Inc.  
Searcy Enterprises  
Sharps Arms Co., Inc., C.  
Shiloh Rifle Mfg.  
Sklany's Machine Shop  
Small Arms Specialists  
Smith & Wesson  
Sound Technology  
Spencer's Rifle Barrels, Inc.  
Springfield Armory  
Springfield, Inc.  
SSK Industries  
STI International  
Stoeger Industries  
Strayer-Voigt, Inc.

Sturm Ruger & Co. Inc.  
Sunny Hill Enterprises, Inc.  
T&S Industries, Inc.  
Taconic Firearms Ltd., Perry Lane  
Tank's Rifle Shop  
Tar-Hunt Custom Rifles, Inc.  
Taurus Firearms, Inc.  
Texas Armory (See Bond Arms, Inc.)  
The A.W. Peterson Gun Shop, Inc.  
The Gun Room Press  
The Gun Works  
Thompson/Center Arms  
Tristar Sporting Arms, Ltd.  
U.S. Fire Arms Mfg. Co., Inc.  
U.S. Repeating Arms Co., Inc.  
Visible Impact Targets  
Volquartsen Custom Ltd.  
Wallace, Terry  
Weatherby, Inc.  
Wescombe, Bill (See North Star West)  
Wessinger Custom Guns & Engraving  
Whildin & Sons Ltd, E.H.  
Whitstone Lumber Corp.  
Wichita Arms, Inc.  
Wichita Arms, Inc.  
Wildey, Inc.  
Wilsom Combat  
Z-M Weapons

## GUNSMITH SCHOOL

American Gunsmithing Institute  
Bull Mountain Rifle Co.  
Colorado Gunsmithing Academy  
Colorado School of Trades  
Cylinder & Slide, Inc., William R. Laughridge  
Lassen Community College, Gunsmithing Dept.  
Laughridge, William R (See Cylinder & Slide Inc)  
Log Cabin Sport Shop  
Modern Gun Repair School  
Montgomery Community College  
Murray State College  
North American Correspondence Schools The Gun Pro  
Nowlin Mfg. Co.  
NRI Gunsmith School  
Pennsylvania Gunsmith School  
Piedmont Community College  
Pine Technical College  
Professional Gunsmiths of America  
Smith & Wesson  
Southeastern Community College  
Spencer's Rifle Barrels, Inc.  
Trinidad St. Jr. Col. Gunsmith Dept.  
Wright's Gunstock Blanks  
Yavapai College

## GUNSMITH SUPPLIES, TOOLS & SERVICES

Ace Custom 45's, Inc.  
Actions by "T" Teddy Jacobson  
Alaskan Silversmith, The  
Aldis Gunsmithing & Shooting Supply  
Alley Supply Co.  
Allred Bullet Co.  
Alpec Team, Inc.  
American Frontier Firearms Mfg., Inc.  
American Gunsmithing Institute  
Baer Custom Inc., Les  
Ballard Rifle & Cartridge Co., LLC  
Bar-Sto Precision Machine  
Bauska Barrels  
Bear Mountain Gun & Tool  
Bengtson Arms Co., L.

Bill's Gun Repair  
Blue Ridge Machinery & Tools, Inc.  
Boyd's Gunstock Industries, Inc.  
Break-Free, Inc.  
Briley Mfg. Inc.  
Brockman's Custom Gunsmithing  
Brown Products, Inc., Ed  
Brownells, Inc.  
Bryan & Assoc.  
B-Square Company, Inc.  
Buffer Technologies  
Bull Mountain Rifle Co.  
Bushmaster Firearms  
C.S. Van Gorden & Son, Inc.  
Carbide Checkering Tools (See J&R Engineering)  
Carter's Gun Shop  
Caywood, Shane J.  
CBC-BRAZIL  
Chapman Manufacturing Co.  
Chicasaw Gun Works  
Choate Machine & Tool Co., Inc.  
Ciener Inc., Jonathan Arthur  
Colonial Arms, Inc.  
Colorado School of Trades  
Colt's Mfg. Co., Inc.  
Conetrol Scope Mounts  
Corbin Mfg. & Supply, Inc.  
CRR, Inc./Marble's Inc.  
Cumberland Arms  
Cumberland Mountain Arms  
Custom Checkering Service, Kathy Forster  
D'Arcy Echols & Co.  
Dem-Bart Checkering Tools, Inc.  
Dixie Gun Works  
Dixie Gun Works  
Dremel Mfg. Co.  
Du-Lite Corp.  
Efficient Machinery Co.  
Entre'prise Arms, Inc.  
Erhardt, Dennis  
Evolution Gun Works Inc.  
Faith Associates  
Falcon Industries, Inc.  
FERLIB  
Fisher, Jerry A.  
Forgreens Tool & Mfg., Inc.  
Forkin, Ben (See Belt MTN Arms)  
Forster, Kathy (See Custom Checkering)  
Gentry Custom Gunmaker, David  
Goodwin's Gun Shop  
Grace Metal Products  
Gre-Tan Rifles  
Gruning Precision Inc.  
Gunline Tools  
Half Moon Rifle Shop  
Hammond Custom Guns Ltd.  
Hastings  
Henriksen Tool Co., Inc.  
High Performance International  
High Precision  
Holland's Gunsmithing  
Ironsighter Co.  
Israel Arms International, Inc.  
Ivanoff, Thomas G. (See Tom's Gun Repair)  
J&R Engineering  
J&S Heat Treat  
J. Dewey Mfg. Co., Inc.  
Jantz Supply  
Jenkins Recoil Pads, Inc.  
JGS Precision Tool Mfg., LLC  
Jonathan Arthur Ciener, Inc.  
Jones Custom Products, Neil A.  
Kailua Custom Guns Inc.  
Kasent Co., Inc.  
Kleinendorst, K. W.  
Korzinek Riflesmith, J.  
LaBounty Precision Reborning, Inc.  
LaFrance Specialties  
Laurel Mountain Forge  
Lea Mfg. Co.



# PRODUCT & SERVICE DIRECTORY

Lee Supplies, Mark  
List Precision Engineering  
Lock's Philadelphia Gun Exchange  
London Guns Ltd.  
Mahovsky's Metalife  
Marble Arms (See CRR,  
Inc./Marble's Inc.)  
Mark Lee Supplies  
Marsh, Mike  
Martin's Gun Shop  
McFarland, Stan  
Menck, Gunsmith Inc., T.W.  
Metalife Industries (See  
Mahovsky's Metalife)  
Michael's Antiques  
Micro Sight Co.  
Midway Arms, Inc.  
MMC  
Mo's Competitor Supplies (See  
MCS, Inc.)  
Mowrey's Guns & Gunsmithing  
Neil A. Jones Custom Products  
New England Custom Gun Service  
Ole Frontier Gunsmith Shop  
Olympic Arms Inc.  
Parker & Sons Shooting Supply  
Parker Gun Finishes  
Paulsen Gunstocks  
PEM's Mfg. Co.  
Perazone-Gunsmith, Brian  
Peter Dyson & Son Ltd.  
Power Custom, Inc.  
Practical Tools, Inc.  
Precision Specialties  
R.A. Wells Custom Gunsmith  
Ranch Products  
Ransom International Corp.  
Reardon Products  
Rice, Keith (See White Rock Tool &  
Die)  
Robert Valade Engraving  
Rocky Mountain Arms, Inc.  
Romain's Custom Guns, Inc.  
Royal Arms Gunstocks  
Rustepufe Laboratories  
Sharp Shooter Supply  
Shooter's Choice Gun Care  
Simmons Gun Repair, Inc.  
Smith Abrasives, Inc.  
Southern Bloomer Mfg. Co.  
Spencer Reblue Service  
Spencer's Rifle Barrels, Inc.  
Spradlin's  
Starr Trading Co., Jedediah  
Starrett Co., L. S.  
Stiles Custom Guns  
Stoney Point Products, Inc.  
Sullivan, David S. (See Westwind  
Rifles Inc.)  
Sunny Hill Enterprises, Inc.  
T&S Industries, Inc.  
T.W. Menck Gunsmith Inc.  
Tank's Rifle Shop  
Texas Platers Supply Co.  
The A.W. Peterson Gun Shop, Inc.  
The Dutchman's Firearms, Inc.  
The Gun Works  
The NgraveR Co.  
The Robar Co.'s, Inc.  
Theis, Terry  
Tom's Gun Repair, Thomas G.  
Ivanoff  
Track of the Wolf, Inc.  
Trinidad St. Jr. Col. Gunsmith Dept.  
Trulock Tool  
Turnbull Restoration, Doug  
United States Products Co.  
Van Gorden & Son Inc., C. S.  
Venco Industries, Inc. (See  
Shooter's Choice Gun Care)  
W.C. Wolff Co.  
Warne Manufacturing Co.  
Washita Mountain Whetstone Co.  
Weigand Combat Handguns, Inc.

Wessinger Custom Guns &  
Engraving  
White Rock Tool & Die  
Wilcox All-Pro Tools & Supply  
Wild West Guns  
Will-Burt Co.  
Williams Gun Sight Co.  
Williams Shootin' Iron Service, The  
Lynx-Line  
Willow Bend  
Windish, Jim  
Winter, Robert M.  
Wise Guns, Dale  
Wright's Gunstock Blanks  
Yavapai College  
Ziegel Engineering

## HANDGUN ACCESSORIES

"Su-Press-On", Inc.  
A.A. Arms, Inc.  
Ace Custom 45's, Inc.  
Action Direct, Inc.  
ADCO Sales, Inc.  
Aimtech Mount Systems  
Ajax Custom Grips, Inc.  
Alpha 1 Drop Zone  
American Derringer Corp.  
American Frontier Firearms Mfg.,  
Inc.  
Arms Corporation of the  
Philippines  
Astra Sport, S.A.  
Autauga Arms, Inc.  
Badger Creek Studio  
Baer Custom Inc., Les  
Bagmaster Mfg., Inc.  
Bar-Sto Precision Machine  
Behlert Precision, Inc.  
Berry's Mfg., Inc.  
Bill's Custom Cases  
Blue and Gray Products Inc. (See  
Ox-Yoke Originals)  
Bond Custom Firearms  
Bowen Classic Arms Corp.  
Bridgeman Products  
Broken Gun Ranch  
Brooks Tactical Systems-Agrip  
Brown Products, Inc., Ed  
Bushmaster Hunting & Fishing  
Butler Creek Corp.  
Cannon Safe, Inc.  
Centaur Systems, Inc.  
Central Specialties Ltd (See Trigger  
Lock Division  
Charter 2000  
Cheyenne Pioneer Products  
Chicasaw Gun Works  
Ciener Inc., Jonathan Arthur  
Clark Custom Guns, Inc.  
Classic Arms Company  
Conetrol Scope Mounts  
Crimson Trace Lasers  
CRR, Inc./Marble's Inc.  
Cylinder & Slide, Inc., William R.  
Laughridge  
D&L Industries (See D.J.  
Marketing)  
D.J. Marketing  
Dade Screw Machine Products  
Delhi Gun House  
DeSantis Holster & Leather Goods,  
Inc.  
Dixie Gun Works  
Doskocil Mfg. Co., Inc.  
E&L Mfg., Inc.  
E. Arthur Brown Co.  
E.A.A. Corp.  
Ed Brown Products, Inc.  
Essex Arms  
European American Armory Corp  
(See E.A.A. Corp)

Evolution Gun Works Inc.  
F.I., Inc. - High Standard Mfg. Co.  
Falcon Industries, Inc.  
Federal Arms Corp. of America  
Feinwerkbau Westinger &  
Altenburger  
Fisher Custom Firearms  
Fleming Firearms  
Freedom Arms, Inc.  
G.G. & G.  
Galati International  
GALCO International Ltd.  
Garcia National Gun Traders, Inc.  
Garthwaite Pistolsmith, Inc., Jim  
Gil Hebard Guns Inc.  
Gilmore Sports Concepts  
Glock, Inc.  
Goodwin's Gun Shop  
Gould & Goodrich  
Gremmel Enterprises  
Gun-Alert  
Gun-Ho Sports Cases  
H.K.S. Products  
Hafner World Wide, Inc.  
Hammer USA  
Heinie Specialty Products  
Henigson & Associates, Steve  
Hill Speed Leather, Ernie  
Hi-Point Firearms/MKS Supply  
Hobson Precision Mfg. Co.  
Hoppe's Div. Penguin Industries,  
Inc.  
H-S Precision, Inc.  
Hunter Co., Inc.  
Impact Case & Container, Inc.  
J.P. Enterprises Inc.  
Jarvis, Inc.  
JB Custom  
Jeffredo Gunsight  
Jim Noble Co.  
John's Custom Leather  
Jonathan Arthur Ciener, Inc.  
Kalispel Case Line  
KeeCo Impressions, Inc.  
King's Gun Works  
KK Air International (See Impact  
Case & Container Co.)  
L&S Technologies Inc. (See  
Aimtech Mount Systems)  
Lakewood Products LLC  
LaserMax, Inc.  
Loch Leven Industries/Convert-A-  
Pell  
Lock's Philadelphia Gun Exchange  
Lohman Mfg. Co., Inc.  
Mag-Na-Port International, Inc.  
Magnolia Sports, Inc.  
Mag-Pack Corp.  
Mahony, Philip Bruce  
Mandall Shooting Supplies Inc.  
Marble Arms (See CRR,  
Inc./Marble's Inc.)  
Markell, Inc.  
McCormick Corp., Chip  
MEC-Gar S.R.L.  
Menck, Gunsmith Inc., T.W.  
Merkuria Ltd.  
Middlebrooks Custom Shop  
Millett Sights  
Mogul Co./Life Jacket  
MTM Molded Products Co., Inc.  
No-Sho Mfg. Co.  
Numrich Gun Parts Corporation  
Omega Sales  
Outdoor Sports Headquarters, Inc.  
Ox-Yoke Originals, Inc.  
Pachmayr Div. Lyman Products  
Pager Pal  
Palmer Security Products  
Parker & Sons Shooting Supply  
Pearce Grip, Inc.  
Perazone-Gunsmith, Brian  
Phoenix Arms  
Practical Tools, Inc.

Precision Small Arms Inc.  
Protektor Model  
Ram-Line ATK  
Ranch Products  
Ransom International Corp.  
Ringler Custom Leather Co.  
RPM  
Seecamp Co. Inc., L. W.  
Simmons Gun Repair, Inc.  
Sound Technology  
Southern Bloomer Mfg. Co.  
Springfield, Inc.  
SSK Industries  
Sturm Ruger & Co. Inc.  
T.F.C. S.p.A.  
Tactical Defense Institute  
Tanfoglio Fratelli S.r.l.  
The A.W. Peterson Gun Shop, Inc.  
The Concealment Shop, Inc.  
The Gun Works  
The Keller Co.  
The Protector Mfg. Co., Inc.  
Thompson/Center Arms  
Trigger Lock Division / Central  
Specialties Ltd.  
Trijicon, Inc.  
Triple-K Mfg. Co., Inc.  
Truglo, Inc.  
Tyler Manufacturing & Distributing  
United States Products Co.  
Universal Sports  
Volquartsen Custom Ltd.  
W. Waller & Son, Inc.  
W.C. Wolff Co.  
Warne Manufacturing Co.  
Weigand Combat Handguns, Inc.  
Wessinger Custom Guns &  
Engraving  
Western Design (See Alpha  
Gunsmith Division)  
Whitestone Lumber Corp.  
Wild West Guns  
Williams Gun Sight Co.  
Wilsom Combat  
Yankee Gunsmith "Just Glocks"  
Ziegel Engineering

## HANDGUN GRIPS

A.A. Arms, Inc.  
African Import Co.  
Ahrends, Kim (See Custom  
Firearms, Inc)  
Ajax Custom Grips, Inc.  
Altamont Co.  
American Derringer Corp.  
American Frontier Firearms Mfg.,  
Inc.  
American Gripcraft  
Arms Corporation of the  
Philippines  
Art Jewel Enterprises Ltd.  
Baelder, Harry  
Baer Custom Inc., Les  
Big Bear Arms & Sporting Goods,  
Inc.  
Bob's Gun Shop  
Boone Trading Co., Inc.  
Boone's Custom Ivory Grips, Inc.  
Boyd's Gunstock Industries, Inc.  
Brooks Tactical Systems-Agrip  
Brown Products, Inc., Ed  
Clark Custom Guns, Inc.  
Cole-Grip  
Colonial Repair  
Crimson Trace Lasers  
Custom Firearms (See Ahrends,  
Kim)  
Cylinder & Slide, Inc., William R.  
Laughridge  
Dixie Gun Works  
E.A.A. Corp.  
EMF Co., Inc.

Essex Arms  
European American Armory Corp  
(See E.A.A. Corp)  
F.I., Inc. - High Standard Mfg. Co.  
Falcon Industries, Inc.  
Feinwerkbau Westinger &  
Altenburger  
Fibron Products, Inc.  
Fisher Custom Firearms  
Forrest Inc., Tom  
Garthwaite Pistolsmith, Inc., Jim  
Goodwin's Gun Shop  
Herrett's Stocks, Inc.  
HIP-GRIP Barami Corp.  
Hogue Grips  
H-S Precision, Inc.  
Huebner, Corey O.  
I.S.S.  
Israel Arms International, Inc.  
John Masen Co. Inc.  
KeeCo Impressions, Inc.  
Kim Ahrends Custom Firearms,  
Inc.  
Korth Germany GmbH  
Lett Custom Grips  
Linebaugh Custom Sixguns  
Lyman Products Corp.  
Mandall Shooting Supplies Inc.  
Michaels Of Oregon, Co.  
Millett Sights  
N.C. Ordnance Co.  
Newell, Robert H.  
Northern Precision Custom  
Swaged Bullets  
Pachmayr Div. Lyman Products  
Pardini Armi Srl  
Parker & Sons Shooting Supply  
Perazone-Gunsmith, Brian  
Pilgrim Pewter, Inc. (See Bell  
Originals Inc. Sid)  
Precision Small Arms Inc.  
Radical Concepts  
Rosenberg & Son, Jack A  
Roy's Custom Grips  
Spegel, Craig  
Stoeger Industries  
Sturm Ruger & Co. Inc.  
Sunny Hill Enterprises, Inc.  
Tactical Defense Institute  
Taurus Firearms, Inc.  
The A.W. Peterson Gun Shop, Inc.  
Tirelli  
Triple-K Mfg. Co., Inc.  
Tyler Manufacturing & Distributing  
U.S. Fire Arms Mfg. Co., Inc.  
Uncle Mike's (See Michaels of  
Oregon Co.)  
Vintage Industries, Inc.  
Volquartsen Custom Ltd.  
Western Mfg. Co.  
Whitestone Lumber Corp.  
Wright's Gunstock Blanks

## HOLSTERS & LEATHER GOODS

A&B Industries, Inc (See Top-Line  
USA Inc)  
A.A. Arms, Inc.  
Action Direct, Inc.  
Action Products, Inc.  
Aker International, Inc.  
AKJ Concealco  
Alessi Holsters, Inc.  
Arratoonian, Andy (See Horseshoe  
Leather Products)  
Autauga Arms, Inc.  
Bagmaster Mfg., Inc.  
Baker's Leather Goods, Roy  
Bandcor Industries, Div. of Man-  
Sew Corp.  
Bang-Bang Boutique (See Holster  
Shop, The)

# PRODUCT & SERVICE DIRECTORY

Beretta S.p.A., Pietro  
Bianchi International, Inc.  
Bond Arms, Inc.  
Brocock Ltd.  
Brooks Tactical Systems-Agrip  
Brown, H. R. (See Silhouette Leathers)  
Browning Arms Co.  
Bull-X, Inc.  
Cape Outfitters  
Cathay Enterprises, Inc.  
Chace Leather Products  
Churchill Glove Co., James  
Cimarron F.A. Co.  
Classic Old West Styles  
Clements' Custom Leathercraft, Chas  
Cobra Sport S.r.l.  
Colonial Repair  
Counter Assault  
Delhi Gun House  
DeSantis Holster & Leather Goods, Inc.  
Dillon Precision Products, Inc.  
Dixie Gun Works  
Ekol Leather Care  
El Paso Saddlery Co.  
EMF Co., Inc.  
Faust Inc., T. G.  
Freedom Arms, Inc.  
Gage Manufacturing  
GALCO International Ltd.  
Garcia National Gun Traders, Inc.  
Gil Hebard Guns Inc.  
Gilmore Sports Concepts  
GML Products, Inc.  
Goodwin's Gun Shop  
Gould & Goodrich  
Gun Leather Limited  
Gunfitters  
Hafner World Wide, Inc.  
HandCrafts Unltd (See Clements' Custom Leather)  
Hank's Gun Shop  
Heinie Specialty Products  
Henigson & Associates, Steve  
Hill Speed Leather, Ernie  
HIP-GRIP Barami Corp.  
Hobson Precision Mfg. Co.  
Hogue Grips  
Horseshoe Leather Products  
Hume, Don  
Hunter Co., Inc.  
Jim Noble Co.  
John's Custom Leather  
K.L. Null Holsters Ltd.  
Kane Products, Inc.  
Kirkpatrick Leather Co.  
Kolpin Mfg., Inc.  
Korth Germany GmbH  
Kramer Handgun Leather  
L.A.R. Mfg., Inc.  
Lawrence Leather Co.  
Lock's Philadelphia Gun Exchange  
Lone Star Gunleather  
Magnolia Sports, Inc.  
Mandall Shooting Supplies Inc.  
Markell, Inc.  
Marksman Products  
Michaels Of Oregon, Co.  
Minute Man High Tech Industries  
Navy Arms Company  
No-Sho Mfg. Co.  
Null Holsters Ltd. K.L.  
October Country Muzzleloading  
Ojala Holsters, Arvo  
Oklahoma Leather Products, Inc.  
Old West Reproductions, Inc. R.M. Bachman  
Pager Pal  
Parker & Sons Shooting Supply  
Pathfinder Sports Leather  
Protector Model  
PWL Gunleather

Ramon B. Gonzalez Guns  
Renegade  
Ringler Custom Leather Co.  
Rogue Rifle Co., Inc.  
Safariland Ltd., Inc.  
Safety Speed Holster, Inc.  
Scharch Mfg., Inc.-Top Brass  
Schulz Industries  
Second Chance Body Armor  
Silhouette Leathers  
Smith Saddlery, Jesse W.  
Sparks, Milt  
Stalker, Inc.  
Starr Trading Co., Jedediah  
Strong Holster Co.  
Stuart, V. Pat  
Tabler Marketing  
Tactical Defense Institute  
Ted Blocker Holsters, Inc.  
Tex Shoemaker & Sons, Inc.  
Thad Rybka Custom Leather Equipment  
The A.W. Peterson Gun Shop, Inc.  
The Concealment Shop, Inc.  
The Gun Works  
The Keller Co.  
The Outdoor Connection, Inc.  
Torel, Inc.  
Triple-K Mfg. Co., Inc.  
Tristar Sporting Arms, Ltd.  
Tyler Manufacturing & Distributing  
Uncle Mike's (See Michaels of Oregon Co.)  
Venus Industries  
Walt's Custom Leather, Walt Whinnery  
Watson Trophy Match Bullets  
Westley Richards & Co.  
Whinnery, Walt (See Walt's Custom Leather)  
Wild Bill's Originals  
Wilsom Combat

## **PISTOLSMITH**

A.W. Peterson Gun Shop, Inc.  
Acadian Ballistic Specialties  
Accuracy Unlimited  
Ace Custom 45's, Inc.  
Actions by "T" Teddy Jacobson  
Adair Custom Shop, Bill  
Ahlman Guns  
Ahrends, Kim (See Custom Firearms, Inc)  
Aldis Gunsmithing & Shooting Supply  
Alpha Precision, Inc.  
Alpine Indoor Shooting Range  
Armament Gunsmithing Co., Inc.  
Arundel Arms & Ammunition, Inc., A.  
Badger Creek Studio  
Baer Custom Inc., Les  
Bain & Davis, Inc.  
Banks, Ed  
Bar-Sto Precision Machine  
Behlert Precision, Inc.  
Ben William's Gun Shop  
Bengtson Arms Co., L.  
Bill Adair Custom Shop  
Billings Gunsmiths  
Bowen Classic Arms Corp.  
Broken Gun Ranch  
Caraville Manufacturing  
Chicasaw Gun Works  
Clark Custom Guns, Inc.  
Cleland's Outdoor World, Inc  
Colonial Repair  
Colorado School of Trades  
Colt's Mfg. Co., Inc.  
Corkys Gun Clinic  
Custom Firearms (See Ahrends, Kim)

Cylinder & Slide, Inc., William R. Laughridge  
D&D Gunsmiths, Ltd.  
D&L Sports  
David R. Chicoine  
Dayton Traister  
Dillioott Gunsmithing, Inc.  
Ellicott Arms, Inc. / Woods  
Pistolsmithing  
Evolution Gun Works Inc.  
F.I., Inc. - High Standard Mfg. Co.  
Ferris Firearms  
Fisher Custom Firearms  
Forkin, Ben (See Belt MTN Arms)  
Forkin Arms  
Francesca, Inc.  
G.G. & G.  
Garthwaite Pistolsmith, Inc., Jim  
Gary Reeder Custom Guns  
Genecco Gun Works  
Gentry Custom Gunmaker, David  
George E. Mathews & Son, Inc.  
Greider Precision  
Guncraft Sports Inc.  
Gunsmithing, Inc.  
Gunsite Custom Shop  
Gunsite Gunsmithy (See Gunsite Custom Shop)  
Gunsite Training Center  
Hamilton, Alex B (See Ten-Ring Precision, Inc)  
Hammerli Service-Precision Mac  
Hammond Custom Guns Ltd.  
Hank's Gun Shop  
Hanson's Gun Center, Dick  
Harris Gunworks  
Harwood, Jack O.  
Hawken Shop, The (See Dayton Traister)  
Heinie Specialty Products  
High Bridge Arms, Inc  
Highline Machine Co.  
Hoag, James W.  
Irwin, Campbell H.  
Island Pond Gun Shop  
Ivanoff, Thomas G. (See Tom's Gun Repair)  
J&S Heat Treat  
Jarvis, Inc.  
Jeffredo Gunsight  
Jensen's Custom Ammunition  
Jungkind, Reeves C.  
Kaswer Custom, Inc.  
Ken Starnes Gunmaker  
Kilham & Co.  
Kim Ahrends Custom Firearms, Inc.  
King's Gun Works  
La Clinique du .45  
LaFrance Specialties  
LaRocca Gun Works  
Lathrop's, Inc.  
Lawson, John G (See Sight Shop, The)  
Leckie Professional Gunsmithing  
Linebaugh Custom Sixguns  
List Precision Engineering  
Long, George F.  
Mag-Na-Port International, Inc.  
Mahony, Philip Bruce  
Mahovsky's Metalife  
Mandall Shooting Supplies Inc.  
Marvel, Alan  
Mathews & Son, Inc., George E.  
McCann's Machine & Gun Shop  
MCS, Inc.  
Middlebrooks Custom Shop  
Miller Custom  
Mitchell's Accuracy Shop  
MJK Gunsmithing, Inc.  
Modern Gun Repair School  
Montgomery Community College  
Mo's Competitor Supplies (See MCS, Inc.)

Mowrey's Guns & Gunsmithing  
Mullis Guncraft  
NCP Products, Inc.  
Novak's, Inc.  
Nowlin Mfg. Co.  
Olathe Gun Shop  
Paris, Frank J.  
Pasadena Gun Center  
Peacemaker Specialists  
PEM's Mfg. Co.  
Performance Specialists  
Peterson Gun Shop, Inc., A.W.  
Pierce Pistols  
Piquette's Custom Engraving  
Power Custom, Inc.  
Precision Specialties  
Ramon B. Gonzalez Guns  
Randco UK  
Ries, Chuck  
Rim Pac Sports, Inc.  
Rocky Mountain Arms, Inc.  
RPM  
Ruger's Custom Guns  
Score High Gunsmithing  
Shooters Supply  
Shootin' Shack  
Singletary, Kent  
Springfield, Inc.  
SSK Industries  
Swenson's 45 Shop, A. D.  
Swift River Gunworks  
Ten-Ring Precision, Inc.  
Terry K. Kopp Professional Gunsmithing  
The A.W. Peterson Gun Shop, Inc.  
The Gun Works  
The Robar Co.'s, Inc.  
The Sight Shop  
Thompson, Randall (See Highline Machine Co.)  
Thurston Sports, Inc.  
Tom's Gun Repair, Thomas G. Ivanoff  
Turnbull Restoration, Doug  
Vic's Gun Refinishing  
Volquartsen Custom Ltd.  
Walker Arms Co., Inc.  
Walters Industries  
Wardell Precision Handguns Ltd.  
Wessinger Custom Guns & Engraving  
White Barn Wor  
Wichita Arms, Inc.  
Wild West Guns  
Williams Gun Sight Co.  
Williamson Precision Gunsmithing  
Wilsom Combat  
Wright's Gunstock Blanks

## **RELOADING TOOLS AND ACCESSORIES**

4-D Custom Die Co.  
Advance Car Mover Co., Rowell Div.  
American Products, Inc.  
Ammo Load, Inc.  
Armfield Custom Bullets  
Armit Laboratories  
Arms Corporation of the Philippines  
Atlantic Rose, Inc.  
Atsko/Sno-Seal, Inc.  
Bald Eagle Precision Machine Co.  
Ballistic Product, Inc.  
Belltown Ltd.  
Ben William's Gun Shop  
Ben's Machines  
Berger Bullets Ltd.  
Berry's Mfg., Inc.  
Blount, Inc., Sporting Equipment Div.  
Blue Mountain Bullets

Blue Ridge Machinery & Tools, Inc.  
Bonanza (See Forster Products)  
Break-Free, Inc.  
Brown Co., E. Arthur  
BRP, Inc. High Performance Cast Bullets  
Brynin, Milton  
B-Square Company, Inc.  
Buck Stix-SOS Products Co.  
Buffalo Arms Co.  
Bull Mountain Rifle Co.  
Bullseye Bullets  
C&D Special Products (See Claybuster Wads & Harvester Bullets)  
Camdex, Inc.  
Camp-Cap Products  
Canyon Cartridge Corp.  
Case Sorting System  
CH Tool & Die Co. (See 4-D Custom Die Co.)  
CheVron Bullets  
Claybuster Wads & Harvester Bullets  
CONKKO  
Cook Engineering Service  
Crouse's Country Cover  
Cumberland Arms  
Curtis Cast Bullets  
Custom Products (See Jones Custom Products)  
CVA  
D.C.C. Enterprises  
Davide Pedersoli and Co.  
Davis, Don  
Davis Products, Mike  
Denver Instrument Co.  
Dillon Precision Products, Inc.  
Dropkick  
E&L Mfg., Inc.  
Eagan, Donald V.  
Eezox, Inc.  
Eichelberger Bullets, Wm.  
Enquix Import-Export  
Euroarms of America, Inc.  
E-Z-Way Systems  
Federated-Fry (See Fry Metals)  
Feken, Dennis  
Ferguson, Bill  
First Inc., Jack  
Fisher Custom Firearms  
Flambeau Products Corp.  
Flitz International Ltd.  
Forster Products  
Fremont Tool Works  
Fry Metals  
Gehmann, Walter (See Huntington Die Specialties)  
Graf & Sons  
Graphics Direct  
Graves Co.  
Green, Arthur S.  
Greenwood Precision  
GTB  
Gun City  
Hanned Precision (See The Hanned Line)  
Harrell's Precision  
Harris Enterprises  
Harrison Bullets  
Haydon Shooters Supply, Russ  
Heidenstrom Bullets  
High Precision  
Hirtenberger AG  
Hodgdon Powder Co.  
Hoeft Sales, Inc.  
Holland's Gunsmithing  
Hondo Ind.  
Hornady Mfg. Co.  
Howell Machine  
Hunters Supply, Inc.  
Hutton Rifle Ranch  
Image Ind. Inc.  
Imperial Magnum Corp.



# PRODUCT & SERVICE DIRECTORY

INTEC International, Inc.  
Iosso Products  
J&L Superior Bullets (See  
Huntington Die Special)  
Javelina Lube Products  
JGS Precision Tool Mfg., LLC  
JLK Bullets  
Jonad Corp.  
Jones Custom Products, Neil A.  
Jones Moulds, Paul  
K&M Services  
Kapro Mfg. Co. Inc. (See R.E.I.)  
Knoell, Doug  
Korzinek Riflesmith, J.  
L.A.R. Mfg., Inc.  
L.E. Wilson, Inc.  
Lapua Ltd.  
Le Clear Industries (See E-Z-Way  
Systems)  
Lee Precision, Inc.  
Legend Products Corp.  
Liberty Metals  
Liberty Shooting Supplies  
Lightning Performance  
Innovations, Inc.  
Lithi Bee Bullet Lube  
Littleton, J. F.  
Lock's Philadelphia Gun Exchange  
Lortone Inc.  
Lyman Instant Targets, Inc. (See  
Lyman Products)  
Lyman Products Corp.  
MA Systems  
Magma Engineering Co.  
MarMik, Inc.  
Marquart Precision Co.  
Match Prep-Doyle Gracey  
Mayville Engineering Co. (See  
MEC, Inc.)  
MCS, Inc.  
MEC, Inc.  
Midway Arms, Inc.  
MI-TE Bullets  
Montana Armory, Inc. (See C.  
Sharps Arms Co. Inc.)  
Mo's Competitor Supplies (See  
MCS, Inc.)  
Mountain South  
Mountain State Muzzleloading  
Supplies, Inc.  
MTM Molded Products Co., Inc.  
Multi-Scale Charge Ltd.  
MWG Co.  
Navy Arms Company  
Newman Gunshop  
North Devon Firearms Services  
Old West Bullet Moulds  
Omark Industries, Div. of Blount,  
Inc.  
Original Box, Inc.  
Outdoor Sports Headquarters, Inc.  
Paco's (See Small Custom Mould  
& Bullet Co.)  
Paragon Sales & Services, Inc.  
Pease Accuracy  
PineTree Bullets  
Ponsness/Warren  
Prairie River Arms  
Prime Reloading

Professional Hunter Supplies (See  
Star Custom Bullets)  
Pro-Shot Products, Inc.  
R.A. Wells Custom Gunsmith  
R.E.I.  
R.I.S. Co., Inc.  
Rapine Bullet Mould Mfg. Co.  
Reloading Specialties, Inc.  
Rice, Keith (See White Rock Tool &  
Die)  
Rochester Lead Works  
Rooster Laboratories  
Rorschach Precision Products  
SAECO (See Redding Reloading  
Equipment)  
Sandia Die & Cartridge Co.  
Saunders Gun & Machine Shop  
Saville Iron Co. (See Greenwood  
Precision)  
Seebeck Assoc., R.E.  
Sharp Shooter Supply  
Sharps Arms Co., Inc., C.  
Shiloh Rifle Mfg.  
Sierra Specialty Prod. Co.  
Silver Eagle Machining  
Skip's Machine  
Small Custom Mould & Bullet Co.  
Sno-Seal, Inc. (See Atsko/Sno-  
Seal, Inc.)  
SOS Products Co. (See Buck Stix-  
SOS Products Co.)  
Spencer's Rifle Barrels, Inc.  
SPG LLC  
SSK Industries  
Stalwart Corporation  
Star Custom Bullets  
Starr Trading Co., Jedediah  
Stillwell, Robert  
Stoney Point Products, Inc.  
Stratco, Inc.  
Tamarack Products, Inc.  
Taracor Industries, Inc.  
TCCI  
TCSR  
TDP Industries, Inc.  
Tetra Gun Care  
The Hanned Line  
The Protector Mfg. Co., Inc.  
Thompson/Center Arms  
TMI Products (See Haselbauer  
Products, Jerry)  
Vega Tool Co.  
Venco Industries, Inc. (See  
Shooter's Choice Gun Care)  
VibraShine, Inc.  
Vibra-Tek Co.  
Vihtavuori Oy/Kaltron-Pettibone  
Vitt/Boos  
W.B. Niemi Engineering  
W.J. Riebe Co.  
WD-40 Co.  
Webster Scale Mfg. Co.  
White Rock Tool & Die  
Widener's Reloading & Shooting  
Supply, Inc.  
Wise Custom Guns  
Woodleigh (See Huntington Die  
Specialties)

Yesteryear Armory & Supply  
Young Country Arms

## SHOOTING/TRAINING SCHOOL

Alpine Indoor Shooting Range  
American Gunsmithing Institute  
American Small Arms Academy  
Auto Arms  
Beretta U.S.A. Corp.  
Bob's Tactical Indoor Shooting  
Range & Gun Shop  
Bridgeman Products  
Chapman Academy of Practical  
Shooting  
Chelsea Gun Club of New York City  
Inc.  
Cherry Creek State Park Shooting  
Center  
CQB Training  
Defense Training International, Inc.  
Executive Protection Institute  
Ferris Firearms  
Front Sight Firearms Training  
Institute  
G.H. Enterprises Ltd.  
Gene's Custom Guns  
Griffin & Howe, Inc.  
Griffin & Howe, Inc.  
Griffin & Howe, Inc.  
Guncraft Books (See Guncraft  
Sports Inc.)  
Guncraft Sports Inc.  
Guncraft Sports, Inc.  
Gunsite Training Center  
Henigson & Associates, Steve  
Jensen's Custom Ammunition  
Jensen's Firearms Academy  
Kemen America  
L.L. Bean, Inc.  
Lethal Force Institute (See Police  
Bookshelf)  
Loch Leven Industries/Convert-A-  
Pell  
Long, George F.  
McMurdo, Lynn (See Specialty  
Gunsmithing)  
Mendez, John A.  
NCP Products, Inc.  
Nevada Pistol Academy, Inc.  
North American Shooting Systems  
North Mountain Pine Training  
Center (See Executive  
Nowlin Mfg. Co.)  
Paxton Quigley's Personal  
Protection Strategies  
Pentheny de Pentheny  
Performance Specialists  
Police Bookshelf  
SAFE  
Shoot Where You Look  
Shooter's World  
Shooters, Inc.  
Sigarms, Inc.  
Smith & Wesson  
Specialty Gunsmithing  
Starlight Training Center, Inc.

Tactical Defense Institute  
The Firearm Training Center  
The Midwest Shooting School  
The Shooting Gallery  
Thunden Ranch  
Western Missouri Shooters  
Alliance  
Yankee Gunsmith "Just Glocks"  
Yavapai Firearms Academy Ltd.

## SIGHTS, METALLIC

100 Straight Products, Inc.  
Accura-Site (See All's, The Jim  
Tembelis Co., Inc.)  
Ad Hominem  
Alley Supply Co.  
All's, The Jim J. Tembelis Co., Inc.  
Alpec Team, Inc.  
Andela Tool & Machine, Inc.  
AO Sight Systems  
ArmaLite, Inc.  
Ashley Outdoors, Inc.  
Aspen Outfitting Co.  
Axtell Rifle Co.  
B.A.C.  
Baer Custom Inc., Les  
Ballard Rifle & Cartridge Co., LLC  
BEC, Inc.  
Bob's Gun Shop  
Bo-Mar Tool & Mfg. Co.  
Bond Custom Firearms  
Bowen Classic Arms Corp.  
Brockman's Custom Gunsmithing  
Brooks Tactical Systems-Agrip  
Brown Co., E. Arthur  
Brown Dog Ent.  
Brownells, Inc.  
Buffalo Arms Co.  
Bushmaster Firearms  
C. Sharps Arms Co. Inc./Montana  
Armory  
California Sights (See Fautheree,  
Andy)  
Campbell, Dick  
Cape Outfitters  
Cape Outfitters  
Cash Mfg. Co., Inc.  
Center Lock Scope Rings  
Champion's Choice, Inc.  
C-More Systems  
Colonial Repair  
CRR, Inc./Marble's Inc.  
Davide Pedersoli and Co.  
DHB Products  
Dixie Gun Works  
DPMS (Defense Procurement  
Manufacturing Services, Inc.)  
E. Arthur Brown Co.  
Evolution Gun Works Inc.  
Faloon Industries, Inc.  
Farr Studio, Inc.  
G.G. & G.  
Garthwaite Pistolsmith, Inc., Jim  
Goergen's Gun Shop, Inc.  
Goodwin's Gun Shop  
Guns Div. of D.C. Engineering, Inc.  
Gunsmithing, Inc.

Hank's Gun Shop  
Heidenstrom Bullets  
Heinie Specialty Products  
Hesco-Meprolight  
Hiptmayer, Armurier  
Hiptmayer, Klaus  
I.S.S.  
Innovative Weaponry Inc.  
J.G. Anschutz GmbH & Co. KG  
J.P. Enterprises Inc.  
Keng's Firearms Specialty, Inc./US  
Tactical Systems  
Knight Rifles  
Knight's Mfg. Co.  
L.P.A. Inc.  
Leapers, Inc.  
List Precision Engineering  
London Guns Ltd.  
Lyman Instant Targets, Inc. (See  
Lyman Products)  
Mandal Shooting Supplies Inc.  
Marble Arms (See CRR,  
Inc./Marble's Inc.)  
MCS, Inc.  
MEC-Gar S.R.L.  
Meprolight (See Hesco-  
Meprolight)  
Merit Corp.  
Mid-America Recreation, Inc.  
Middlebrooks Custom Shop  
Millett Sights  
MMC  
Modern Muzzleloading, Inc.  
Montana Armory, Inc. (See C.  
Sharps Arms Co. Inc.)  
Montana Vintage Arms  
Mo's Competitor Supplies (See  
MCS, Inc.)  
Navy Arms Company  
New England Custom Gun Service  
Newman Gunshop  
Novak's, Inc.  
OK Weber, Inc.  
One Ragged Hole  
Parker & Sons Shooting Supply  
PEM's Mfg. Co.  
Perazone-Gunsmith, Brian  
RPM  
Sharps Arms Co., Inc., C.  
Slug Site  
STI International  
T.F.C. S.p.A.  
Talley, Dave  
Tank's Rifle Shop  
The A.W. Peterson Gun Shop, Inc.  
The Gun Doctor  
Trijicon, Inc.  
Truglo, Inc.  
United States Optics Technologies,  
Inc.  
Warne Manufacturing Co.  
Weigand Combat Handguns, Inc.  
Wichita Arms, Inc.  
Wild West Guns  
Williams Gun Sight Co.  
Wilsom Combat  
Wilsom Combat

# Knowledge IS Power

**C**hoosing a gun for personal defense and learning to use it can be an intimidating situation. *The Gun Digest® Book of Guns for Personal Defense* gives you the information you need to make the right choice. With informative articles from award-winning writers to an in-depth catalog section giving values and prices for new and used guns and accessories, this book puts you on the path to personal defense. The rest is up to you.

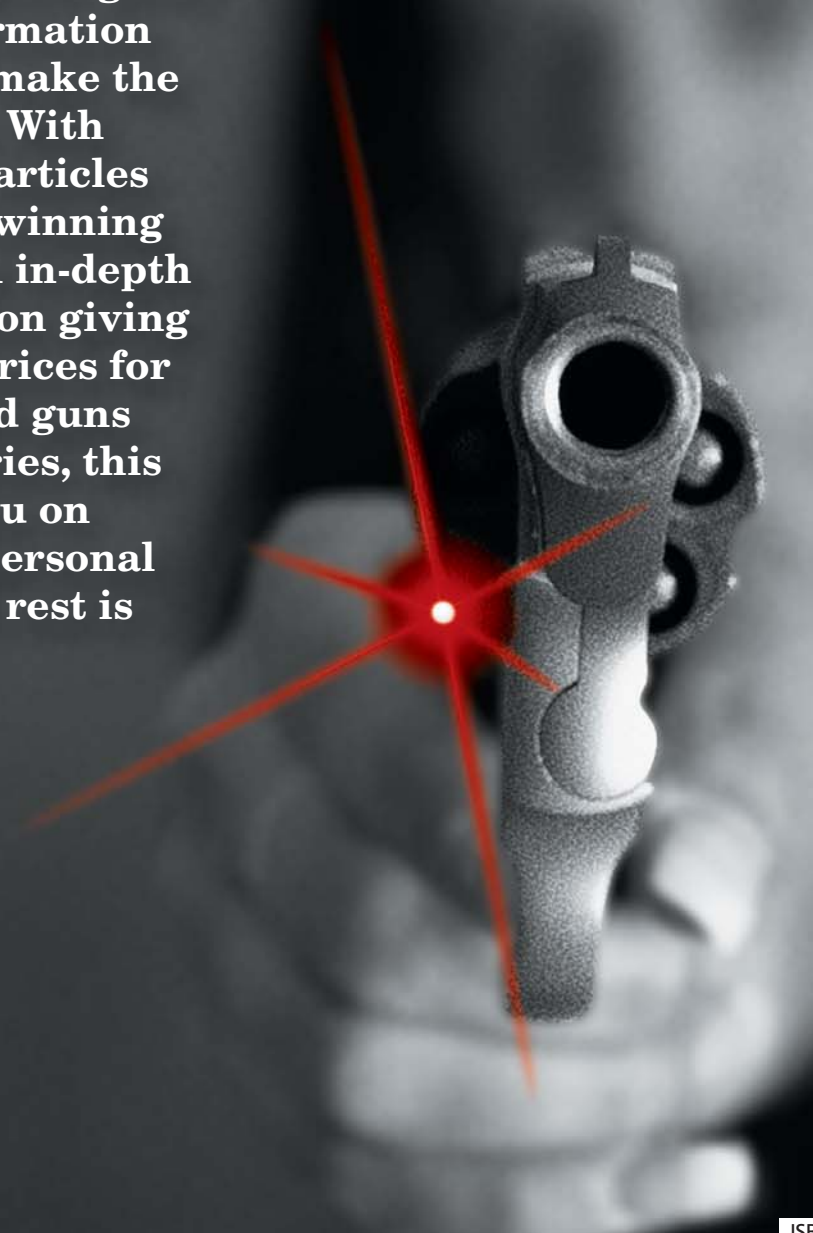

**kp books**

An imprint of F+W Publications, Inc.  
888-457-2873

ISBN: 0-87349-931-X **\$14.99 U.S.**  
(\$22.99 CAN)



51499

